



## Louie's Gouie's Application Table of Contents

### Required Application

1. Cannabis Retail Use Application Completeness Review Time Extension
2. Stormwater Determination Worksheet
3. Environmental Assessment
4. Company Overview
  - a. Introduction
  - b. Business model
  - c. Core principles
5. Company structure and principal qualifications
  - a. Entity structure
  - b. Principal experience and qualifications
6. Regulatory approvals and compliance
  - a. State compliance
    - i. Commercial cannabis use
    - ii. Separation of license types
    - iii. Medicinal/adult use
    - iv. State license display
  - b. County and regional permits
  - c. City of Santa Rosa General Plan
  - d. City of Santa Rosa Municipal Code
  - e. Building and fire codes
  - f. License maintenance
  - g. Substantially related offenses review
  - h. Labor peace agreement
  - i. California Environmental Quality Act
7. Premises plan
  - a. Neighborhood context (Maps included)
  - b. Location requirement
  - c. Existing property description
  - d. Proposed property improvements
    - i. Site plan, elevations, and floor plans reference (Architectural plan set attached)
    - ii. Parking analysis
    - iii. Secured access and product locations
    - iv. Storefront signage and window treatments

8. Operations plan
  - a. Operations framework
  - b. Business license type and responsibilities
  - c. Daily cannabis retail operations
    - i. Hours of operation
    - ii. Protocol for patients and customers
    - iii. Protocol for deliveries and onsite consumption
  - d. Marketplace, advertising, menus, and price lists
  - e. Financial management and recordkeeping
    - i. Employee register
    - ii. Recordkeeping
  - f. Inventory tracking and traceability
  - g. Estimated construction and readiness timeline
  - h. Finances
  - i. Hours of operation
  - j. Insurance certificates
9. Neighborhood compatibility and enhancement plan
  - a. Neighborhood compatibility
    - i. Parking and transportation
    - ii. Safety and security
    - iii. Nuisance management
      1. Outdoor lighting
      2. Noise
      3. Onsite consumption
  - b. Neighborhood enhancement
    - i. Site improvements
    - ii. Environmental benefits
    - iii. Community benefits
    - iv. Employment opportunities
  - c. Product enhancement
    - i. Product storage and handling controls
    - ii. Child resistant packaging
    - iii. Not attractive to children
    - iv. Properly labeled
10. Safety and security plan
  - a. Site/floor plan
  - b. Narrative description of security measures for the business
  - c. Procedures related to handling of cannabis, cannabis products, currency, and transport



- d. Daily delivery operations
  - e. Identity and contact information of business liaison
  - f. Building/site improvements related to security
11. Odor mitigation plan
- a. Overview
  - b. Operations
  - c. Recordkeeping systems and forms
  - d. Maintenance
  - e. Engineering controls

### **Merit-Based Application**

- A. Site management plan
- B. Regulatory compliance and approvals
- C. Neighborhood compatibility
  - a. Neighborhood context maps
  - b. Neighborhood and property photo plates
- D. Neighborhood enhancement
- E. Waste Management & Recycling Plan
- F. Standard operating procedures
- G. Armed robbery prevention plan
- H. Injury and illness prevention plan
- I. Fire suppression and safety plan
- J. Delivery driver safety policy
- K. Employee handbook
- L. Property photo plate
- M. Neighborhood photo plate
- N. Materials board
- O. Louie's Gouies Cannabis Menu
- P. Product brochures
- Q. Labor & Employment

### **Attachments**

- **Architectural plan set**



**Project Name:** Louie's Gouie's  
**File No:** CUP18-058  
**Project Address:** 316 Yolanda Ave

June 21, 2018

Kristinae Toomians, Senior Planner  
City of Santa Rosa  
Planning Department  
100 Santa Rosa Avenue  
Room 3  
Santa Rosa, CA 95404

**SUBJECT: NOTIFICATION OF INCOMPLETE APPLICATION**

Project Name: Louie's Gouie's  
File No.: CUP18-058  
Project Address: 316 Yolanda Ave  
Date Application: Received: April 19, 2018  
Proposed Cannabis: Use(s): Retail (Dispensary) and Delivery

Dear Ms. Toomians,

Please accept this letter and package as a response to your recent incomplete notice letter of May 31<sup>st</sup>. We appreciate the opportunity to return our updated and complete package for your review at this time. Within the contents of this letter, each of your concerns is listed along with a brief explanation of where the complete response can be found in the attachments that follow this Merit-Based Review package. Specific texts requested have been copied herein for your ease of reference. We have organized this special package in alignment with your original letter to provide the most efficient review process possible for you and your team.

It is our sincere hope that throughout this entire resubmittal, we have demonstrated our commitment to running a compliant dispensary and delivery operation in the City of Santa Rosa. Please do not hesitate to contact Chris Cox, our Senior Project Manager at BeGreenLegal, at [ccox@begreenlegal.com](mailto:ccox@begreenlegal.com) or (916) 517-6291 should you have any questions regarding this package.

Following is the list of concerns and responses related to the incomplete application letter mentioned above beginning with the first item on your original list and ending with the last:

<input checked="" type="checkbox"/>	<b>Cannabis retail use applications Completeness review time extension</b>	Signed by the applicant.
-------------------------------------	--	--------------------------

The Cannabis Retail Use of Applications Completeness Review Time Extension form has been completed and signed per your request and follows this letter as Attachment No.1.

<input checked="" type="checkbox"/>	<b>Storm Water Determination Worksheet</b>	
-------------------------------------	--	--





The Storm Water Determination Worksheet has been completed per your request and follows this letter as Attachment No.2.

<input checked="" type="checkbox"/>	<b>Environmental Assessment</b>	
-------------------------------------	---------------------------------	--

The Environmental Assessment has been completed per your request and follows this letter as Attachment No.3.

<input checked="" type="checkbox"/>	<b>Project Description Narrative:</b>	This shall be a written statement that includes descriptions of how the operation meets each of the General Operating Requirements set forth in Section 20-46.050 of the Santa Rosa Code, and provides the following specific information:
-------------------------------------	---------------------------------------	--

The Business and Operations Narrative (Attachment No. 5) in the application package describes our operation in great detail, describing how each of the following bullet points are conceptualized and carried out in our day to day business activities. Our regulatory and compliance section specifies exactly how we intend to align with the City of Santa Rosa Section 20-46.050 and 20-46.080 of the Santa Rosa Code.

<input checked="" type="checkbox"/>	<b>Commercial Cannabis Use</b>	Specify the Cannabis use—Medicinal, Adult Use, or both—for which application is being made.
-------------------------------------	--------------------------------	---

The use type for our proposed dispensary is described as follows and also in more complete detail within the context of the operations, in the Business and Operations Narrative which follows this letter as Attachment No.5.

<input checked="" type="checkbox"/>	<b>Compliance</b>	Describe how the project complies with applicable state licensing requirements and conditions including, but not limited to, operational standards such as background checks, prior felony convictions, restrictions on multiple licenses and license types and locational criteria. [Section 20-46.050 (A)]
-------------------------------------	-------------------	--

We have detailed areas of compliance throughout our application and these standards can be found within the attached documents as indicated throughout this response letter. The complete Regulatory section relating to 20-46.050 and 20-46.080 Can be found in Section 3 - Regulatory Compliance. Additional Sections containing this information are, Section 5 - Business and Operations Narrative, and Section 12 - Employment and Hiring Practices. Additional Standard Operating Procedures and Standardized Plans attached hereto will demonstrate the processes that will be implemented regarding these activities. A Neighborhood Context Map showing the zoning and land use and including a visual of the area 600’ around the perimeter is also included.



<input checked="" type="checkbox"/>	<b>Separation of License Types</b>	Where multiple license types are proposed at the same physical address, demonstrate that clear separation between license types will be maintained at all times. [Section 20-46.0509 (D)]
-------------------------------------	------------------------------------	--

Only one license Type 10 is being applied for by Louie's Gouie's.

<input checked="" type="checkbox"/>	<b>Building and Fire Codes</b>	Describe how the project complies with building and fire codes and include a declaration that the cannabis operator will obtain all necessary building permits, fire permits, and CUPA permits, and provide a Fire Department lock box for keys to gates and doors. [Section 20-46.050 (E)]
-------------------------------------	--------------------------------	--

Our Regulatory Compliance Section, Attachment No.4, will show a complete description of all our compliance related activities. The Attached Fire Suppression & Safety Plan, which accompanies our Standard Operating Procedures describes each step of our implementation process in greater detail.

<input checked="" type="checkbox"/>	<b>Security Plan</b>	Provide a security plan, which must include the following minimum requirements pursuant to Section 20-46.050(G). Because security plans are not publicly available, the security plan should be a separate document: i. Provisions for and locations of security cameras. ii. Verification that a professionally monitored alarm system will be installed. iii. Demonstration of safe and secure product storage including outdoor waste receptacles. iv. Demonstration of facility and process for safe and secure transportation and delivery. v. Verification that commercial grade door and window locks will be installed. Demonstration of emergency access in compliance with state and local standards.
-------------------------------------	----------------------	---

A Security plan addressing all of the concerns listed above has been created for Louie's Gouie's is attached as Section 8. In addition, Section 4 - Premises Plan, Section 5 – Business and Operations Narrative and The attached Vehicle & Driver Safety Policy contain important information pertaining to this section and how we plan to implement our compliance in the day to day dispensary operations.



<input checked="" type="checkbox"/>	<b>Odor Mitigation Plan</b>	Provide an odor mitigation plan, which plan <b><u>must be certified by a licensed professional engineer</u></b> to ensure that all mitigation controls are sufficient to effectively mitigate odors from all odor sources. [Section 20-46.050(H)]
-------------------------------------	-----------------------------	---

An Odor Mitigation Plan has been drafted and certified by a licensed professional engineer and will be found in Section 9 of the Narrative.

<input checked="" type="checkbox"/>	<b>Outdoor Lighting</b>	Description of best management practices and technologies used to reduce glare, light pollution and light trespass onto adjacent properties. Demonstrate compliance with the City's Outdoor Lighting Ordinance (Section 20-30.080, Outdoor Lighting).
-------------------------------------	-------------------------	---

A detailed description of our Outdoor lighting can be found in the Architectural and Lighting Plan set that follows this package and additional details can be found in the Neighborhood Compatibility and Enhancement Plan in Section 7 of the Narrative.

<input checked="" type="checkbox"/>	<b>Noise</b>	Description of how the project will comply with the City's Noise Ordinance (City Code, Chapter 17-16).
-------------------------------------	--------------	--

The Neighborhood Compatibility and Enhancement Plan in Section 7 addresses how we will comply with the City's Noise ordinance.

<input checked="" type="checkbox"/>	<b>Accessory Use(s)</b>	Specify and describe any activities that may be considered an Accessory Use (Office, non-Cannabis Warehouse/Storage, etc.)
-------------------------------------	-------------------------	--

The entire premises of Louie's Gouie's dispensary will be dedicated to the operations of this single, dual-licensed dispensary. As can be seen in the Architectural Plans Attachment (12), the dispensary is divided into a reception, retail and display area and break and storage rooms with one office located in the rear of the building. The office area will be utilized to monitor premises security and to attend to administrative functions of the dispensary. No additional uses of the dispensary are being considered at this time.

<input checked="" type="checkbox"/>	<b>Vicinity and Neighborhood Context Maps</b>	These maps will describe your proposed project's location within the City of Santa Rosa (Vicinity Map at approximately 1:76,000 feet scale) and the land uses and development surrounding the proposed site (Neighborhood Map at approximately 1:4,800 feet scale).
-------------------------------------	---	---

Three Vicinity and Neighborhood Context Maps are attached which show surrounding property information and land use and development surrounding the proposed dispensary. A 600' buffer is also shown on the maps including indicators for all zoning delineations.

☒	<b>Site Plan, Elevations, and Floor Plans</b>	<p>a. Site Plan – dimensioned plan of project site that includes parcel lines, ingress/egress locations, all existing structures, all parking (with vehicle travel indicated if necessary), and any additional features such as trees, landscape areas, etc. Also include any outdoor waste receptacles and facilities to ensure the safe delivery and transportation of Cannabis product.</p> <p>b. Elevations – visual representations of existing and proposed structures, including fences, from all sides. Photos may be utilized; however, dimensions must be provided.</p> <p>c. Floor Plans – dimensioned diagram of building(s) including all rooms, windows, and points of entry/exit.</p>
---	---	--

Please refer to the attached Architectural Plan Set complete with project dimensions, parcel lines, ingress/egress locations and each of the requirements listed in the comment above. A Neighborhood Photo Plate showing photographs of the location and its surroundings with descriptions as well as a Property Photo Plate also follows this narrative.

☒	<b>Parking Analysis</b>	Provide a count of all parking spaces that are described on the Site Plan. Discuss how you will meet the parking requirement for your proposed use (see Zoning Code Section 20-36.040, Table 3-4). If re-tenanting an existing space, provide a description of the location's previous use.
---	-------------------------	---

A complete and detailed parking analysis can be found in Section 7– Neighborhood Compatibility and Enhancement Plan.

☒	<b>Hours of Operation</b>	Description of the proposed hours of operation including days of operation. Provide any information about days/hours for commercial deliveries.
---	---------------------------	---

Our proposed dispensary will run 7 days weekly. The Business & Operations Plan – Section 5 provides the hours of operation and further details on the day to day operations of the dispensary.

☒	<b>Location requirement</b>	Using a map graphic, demonstrate that your proposed location complies with the minimum required setback to schools. Illustrate on the required Site Plan that the storefront entrance is in a visible location that provides an unobstructed view from the public right-of-way [Section 20-46.080 (D)].
---	-----------------------------	---



The attached Neighborhood Context Maps show aerial photographs with a visual 600' boundary and delineations for zoning and land use.

<input checked="" type="checkbox"/>	<b>Medicinal/Adult Use</b>	Specify if your proposed use is Medicinal (dispensary) or Adult Use (retail).
-------------------------------------	----------------------------	---

Our proposed dispensary will be applying to the state for both Medical (M) and Adult Uses (A). Section 5 discusses this in greater detail.

<input checked="" type="checkbox"/>	<b>Operational Plan</b>	Demonstrate that your operation will: Maintain an employee register; Keep proper records in compliance with state law Publish and implement a protocol and requirements for patients and persons entering the site; Identify secured access and secured product locations; and Display a copy of issued State License.
-------------------------------------	-------------------------	---

Regulatory compliance is a strong focus of our application and as such, is discussed in all of the documents throughout. The Business and Operations Narrative – Section 5 will accurately demonstrate all of the above.

<input checked="" type="checkbox"/>	<b>Deliveries, On-Site Consumption</b>	Provide a detailed narrative of any Delivery Services and On-site Consumption activities proposed.
-------------------------------------	--	--

The attached Regulatory Compliance (Section 3) specifies details with regard to our delivery services and consumption activities about the premises. A more complete Narrative with flowchart will be found in the Business and Operations Plan that follows as Attachment No. 5. Our attached Company Manual of Standard Operating Procedures specifies how we intend to comply with these requirements from a practical standpoint and details the specific processes and procedures that will be followed.

<input checked="" type="checkbox"/>	<b>Special Events</b>	See Special events requirements in Required Application Materials checklist
-------------------------------------	-----------------------	---

Louie's Gouie's does not intend to hold or apply for any special events as a function of its operation.

<input checked="" type="checkbox"/>	<b>Storefront, Signage, and Window Treatments</b>	Description of proposed storefront design (supported by required elevations), advertising and signs including signs regarding public consumption (a separate sign permit may be required for certain signs), and proposed window treatments.
-------------------------------------	---	--



This item is discussed in detail in Section 4 – Premises of the attached Narrative.

<input checked="" type="checkbox"/>	<b>Site Management Plan</b>	See Site Management merit-based review criteria.
-------------------------------------	-----------------------------	--

Please see complete response below under the Site Management Merit-based Review Criteria.

<input checked="" type="checkbox"/>	<b>Merit-based Review</b>	Each application will be evaluated on four criteria. Points will be awarded based on how effectively the application responds to or meets the requirements for each criterion. A total of 100 points may be awarded for all criteria. Narrative description, site or building plans, or other text or visual exhibits may be used to respond to each criterion.
-------------------------------------	---------------------------	---

We recognize the complexity of the review process and have purposely organized this special package to assist your team in its Merit-based review. Each Section of this merit based package which follows this narrative letter will contain a separate divider sheet for each section of interest.

<input checked="" type="checkbox"/>	<b>Local and State Compliance</b>	<ul style="list-style-type: none"> <li>i. State regulations</li> <li>County/regional permit requirements</li> <li>Santa Rosa General Plan policies</li> <li>iv. Santa Rosa City Code locational and operational requirements</li> </ul>
-------------------------------------	-----------------------------------	---

Please see Attachment A\_Regulatory Compliance which addresses each of the concerns listed above.

<input checked="" type="checkbox"/>	<b>Site Management</b>	<ul style="list-style-type: none"> <li>Experience in operating a cannabis retail business in the North Bay area</li> <li>Qualifications and backgrounds of principals</li> <li>Business Plan that includes day-to-day operations and how cannabis will be monitored to prevent diversion</li> <li>Management plan that prevents and responds to potential nuisance impacts (e.g. loitering, trash, local contact) on adjoining properties, public areas, and the surrounding neighborhoods</li> <li>Performance timeline from land use approval to plan check and construction to opening</li> </ul>
-------------------------------------	------------------------	--

A complete Site Management plan addressing all of the above follows as Attachment B.





<input checked="" type="checkbox"/>	<b>Neighborhood Compatibility</b>	<ul style="list-style-type: none"> <li>i. Description of how the use will fit into the stability and quality of the surrounding neighborhood</li> <li>ii. Description of odor control measures to prevent odor from being detectable from adjacent properties or businesses</li> <li>iii. Description of how an enhanced retail experience will be achieved with a well-designed site plan and use of quality materials in interior and exterior finishes</li> <li>iv. Demonstrate a clear and attractive entrance, pedestrian orientation, bike parking, and access to transit.</li> </ul>
-------------------------------------	-----------------------------------	---

Our Neighborhood Compatibility Plan addressing all of the above follows as Attachment C.

<input checked="" type="checkbox"/>	<b>Neighborhood Enhancement</b>	<ul style="list-style-type: none"> <li>i. Quality and extent of improvements to the site, building, and surrounding neighborhoods</li> <li>ii. Integration of project through attractive façade, setbacks, quality materials and colors, landscaping, safe circulation and location of driveways, and ease of parking</li> <li>iii. Environmental benefits - green business practices related to energy and/or water conservation</li> <li>iv. Community benefits e.g. employment opportunities, community programs and contributions.</li> </ul>
-------------------------------------	---------------------------------	---

The Neighborhood Enhancement Plan addressing all of the above follows as Attachment D.

This Concludes our responses to the Incomplete Notice letter of May 31. 2018. The Table of Contents and Attachment packet indicated herein follow this letter. We hope this package has demonstrated our commitment to adhering to all application requirements and assisted you in the most efficient review of our information possible. We sincerely appreciate this opportunity to re-submit our package for review and look forward to working with you in the future.

Sincerely,  
The BeGreenLegal Project Management Team  
On behalf of  
Luis & Delia Chavez



## A. Site Management Plan

### A1. Experience in Operating a Cannabis Retail Business in the North Bay Area:

As the Qualifications and background descriptions below will show, Luis Chavez has built and run many businesses in the North Bay area and seeks to include his wife Delia who has worked in the private sector in support of his ventures these many years.

#### *Cannabis Experience*

In search of help for his son's mental health issues, Luis researched the beneficial properties of cannabis and what ailments they may alleviate. Thankfully, cannabis had such a positive impact on their son that he decided to help others in similar circumstances as a legal Caregiver Cultivator under California's Proposal 215. Through the combination of Luis' professional "green thumb" and his faith and devotion to help others in need of medicinal cannabis Luis decided to start a cannabis delivery service which he operated successfully until January 2018. As a former delivery service operator, Luis is very aware of the challenges facing the dispensaries and delivery services within the North Bay and the legal avenues available to them. He is very aware of the need to offer a wide variety of flower at price points that enable every family's budget to afford medicine. He prides himself on a level of customer service that's only possible when you are small business operator and whole heartily care and value your patient/customers.

He has attended several conferences and has networked with many cultivators, dispensaries, and collectives throughout the state in search of the best ways to help others. His crops have won awards and earned him respect within the cannabis industry. His substantial network within the cannabis industry will benefit the Santa Rosa community in taking advantage of legal cannabis that will ultimately generate taxes revenue and create jobs. His menu of products spans the ultra-high, top-shelf flower to budget-friendly options for patients with little to no funds available.

Luis' advanced background with cannabis genetics and his knowledge of cultivation techniques, specifically which strains have been proven to help with certain ailments, such as mental illness, anxiety, and the ravages of military service, such as PTSD will be a key differentiator for Louie's Gouie's.

### A2. Qualifications and Backgrounds of Principals:

#### **Luis Chavez**

Luis Chavez is not only a business man but a proud long-term member of the Santa Rosa community. He was born in the Community Hospital and graduated with honors from Montgomery High School just 3 miles away from his proposed dispensary location. His whole life has been in and devoted to improving life throughout Santa Rosa and Sonoma County.

Almost three decades ago, he met and fell in love with his lovely wife, Delia, of over 25 years and partner in this venture with whom he raised their two children, a daughter who is about to become a Registered Dental Assistant and adult son with special mental health needs.

A super active member of his Latino community, he donates his time and money to several great causes both formal and informal year-round. Whether they are feeding and providing clothing for the homeless,





buying toys for children at Christmas time, or helping keep the Santa Rosa parks clean and safe for their neighborhood kids, Luis and Delia are always looking for ways to help their community.

Professionally, Luis has started and operated several businesses related to real estate, landscaping, and renovations, including three that were state licensed like cannabis. These licenses allowed Luis to properly and safely remediate the damages from mold and contaminated buildings, as well as, providing life insurance as a licensed agent. He has been trusted by the State to keep its residents safe and secure with the most valuable possessions – their homes and lives.

The property in which Louie's Gouies is proposing to operate is in need of Luis' particular skills of renovation and outdoor beautification. The property at 316 Yolanda has been an eyesore to its neighbors and will be greatly enhanced when the City approves this application.

### **Delia Chavez**

For me starting a business in the cannabis industry is more than just a source of income, it's about the opportunity to give back. Over the past 5 years, unfortunately and fortunately, I have come to know the medicinal and healing benefits of cannabis. Even though my husband has years of experience and knowledge and has used cannabis for his anxiety disorder. I personally have never used or ever had much interest in cannabis until the day I had to put a Section 5150 hold on my 22-year old son. My son could no longer deal with pain he felt from a car accident and the withdrawals he was going through from the narcotics he was prescribed for the pain were too much for him.

At that time, I had worked in a pharmacy for 10 years, I had witnessed first-hand the pain and suffering the pharmaceutical dependency had caused to so many of our youth. I had countless conversations, heard heartbreaking stories and wiped so many tears from family members feeling lost and hopeless over how to help their loved ones.

My heart and prayers always went out to them and I thought, there has to be some kind of alternative way to deal with pain. I would always end my thought with, I wish there was something I could do to help. That thought turned into determination after picking up my son from a 14 day hold in a mental institution. He was released to me with a prescription for 7 medications, 2 of which were for pain. For 14 days he had been given over 12 medications and different doses to "help" his psychosis. Needless to say, this created such a chemical imbalance in my son, it led to a 4-year path of pure heartache for our family.

I had my son very young. We basically grew up together and we were best friends. After many unsuccessful attempts to find the correct medication and dosing, I was no longer his best friend or even his mom, I was now the "enemy" or "lady" as he called me. There had been a point I could only imagine the fear and heartache the parents I dealt with through my work felt, now I was the parent with constant gut wrenching fear that I would open a closed door and find my son dead.

That was me until the day my fear and heartache turned to pure anger. Determined not to let my son be another statistic, I read any and every book and article I could find in hopes of a way to help him. I had learned a growing number of males between the age of 20-25 are being diagnosed with onset paranoid schizophrenia which can be brought on by chemical use. After learning that a pain prescription was the potential culprit that had lead our family down this dark path, I was determined to educate myself and find an alternative method of pain management that was safe for long-term use. I reached into my family



roots and found my grandfather's recipes for cannabis tinctures. He would make these tinctures for his arthritis pain and muscle aches and share these with family members and friends.

After experiencing some success with the tinctures and learning the healing benefits of CBD Oil, I realized my anger and determination had become a passion, not only to help my son but to help others by advocating an alternate way of pain management. Although I believe pharmaceuticals have their place in therapy, in good conscience I felt I could no longer work in this field. After 10 years and financial stability, I gave my 2-week notice and enrolled in the Neuromuscular program at Berkeley. I completed the program as a Certified Neuromuscular Therapist and opened up my practice specializing in pain management through the incorporation of CBD tinctures.

Not only had this made a difference in my client's quality of life, it's been instrumental in managing my son's pain, which in-turn has allowed him to eliminate his intake of pain prescriptions. The medicinal benefits of CBD oils have had a huge impact on my son's mental health. I am fortunate and happy to say I am "mom" again! For me, this business is not so much of what I can get, but what I can give. If our work helps even one person as we use this business as a platform for educating an alternative way of healing for us all; the heartache, money, time energy and perhaps even countless arguments of balance will have been worth it! It is our hope to help impact the mental health crisis and create a sense of community and much needed support for Sonoma County.

### A3. Day to Day Operations

Behind the great customer service and fantastic products that Louie's Gouie's will be supplying the cannabis customers of Santa Rosa will be a well-oiled, interconnected logistics, and data-rich machine making sure we are complying with all applicable state and local laws, as described in our regulatory section, while being profitable, and keeping our promises to the City, state, and our clientele.

California's high-tech sector is very actively developing software that makes running and purchasing from a dispensary, both at a storefront and via delivery, much more efficient and satisfying. We will be taking full advantage of these advancements as a way to deliver value and keep our costs down. Our patients and customers will be linked with our staff and inventory and our transactions will be recorded in a transparent and compliant manner for regulators and city officials to review.

In essence, we have one stockpile of inventory that will have been expertly curated by our leadership in conjunction with licensed distributors and brands that is being accessed by two channels of customers – in-store guests and via delivery drivers. As a result, we are laying out our business and operations plans to reflect this two-prong approach.

#### *Operations Framework*

The Staffing Framework (1) flowchart shown below indicates the specific positions we will need within our company to operate our Type 10 Dispensary with local delivery capability. However, as we grow, our staff will function as multiple roles. The owners of Louie's Gouie's are committed to serving in the capacity of Board of Directors and direct Supervisors for the future facility. At this time, we are creating the conceptual platform for future operations based upon our knowledge and experience within the industry as we have indicated throughout this narrative. At the appropriate phase of licensure, our owners will begin expanding the team with key supervisors and staff that will develop and train the remainder of the



dispensary's day to day operatives. The company's organizational structure here contains the list of positions for which basic job descriptions will be considered as follows:

**Board of Directors:** Each member of the Board of Directors will be responsible for preserving the integrity of the Louie's Gouies mission from their position on the Board and their various activities within the company. The Chairman will serve as the Chief Volunteer of the organization and will be the primary liaison for selecting new projects for the company's community involvement and strategic planning. The Chair will partner with the Head of Facilities and fellow Board member in enacting the goals set by the Board. The Head of Facilities will oversee the operations and discuss issues confronting the organization with the Board at regularly scheduled meetings. Both the Chair and the Financial officer will monitor financial planning and reports. All Board directives will be carried out by the General Manager who will also attend as a Board member at all meetings and report on the implementation of the Board's goals. A system of checks and balances in place will ensure adequate oversight and routine evaluations of both members and processes.

**Flow Chart 1**  
**Staffing Framework**

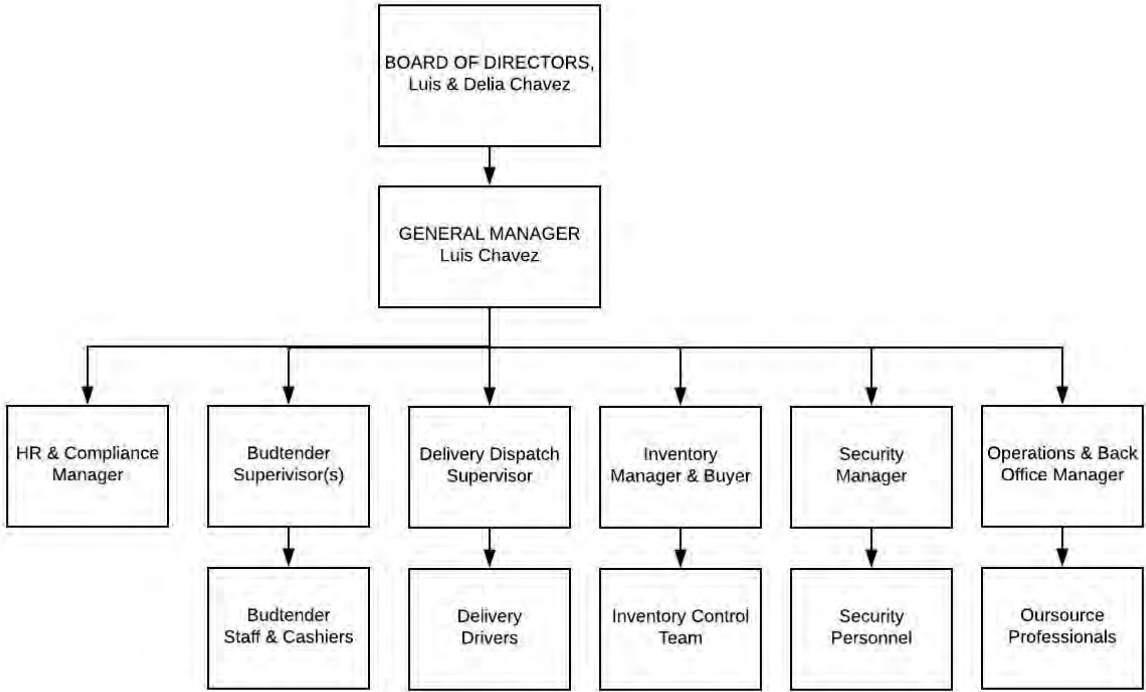

**General Manager (GM):** The General Manager will oversee all department managers and their employees, implementing a company culture that supports the mission and directives of the Board of Directors. The General Manager will also be responsible for development and implementation of policies and procedures, as well as the review process for Standard Operating Procedures (SOPs), record-keeping, inventory and all other maintenance and compliance operations. The GM will create and maintain budgets



under the direction of the Board and will facilitate the implementation of those budgets throughout the various departments with each department head. Additionally, this manager will oversee the routine evaluation of employees, company performance, and deficiencies/efficiencies throughout the facility.

**HR & Compliance Manager (HRCM):** This professional will work hand in hand with the GM to ensure that all regulatory policies and procedures have been documented, implemented and communicated. The HRCM will assist in developing policies and procedures that ensure compliance across departments in necessary HR Training and employee management. This position will also oversee the compliant and accurate maintenance of vital company records and documents and will be the contact responsible for producing such documents upon request from compliance authorities and other enforcement personnel. It is likely that this position will be filled by a staff member who has been recruited from a previously licensed state; this specialized expertise will be used to coordinate all cannabis education and staff training as well as implementing traditional employee orientations regarding discrimination, harassment and professionalism.

**Budtender Supervisors:** Budtender Supervisors will be required to have some previous experience with cannabis whether in an educational capacity, a medical capacity, or an expert capacity as in previous experience in a management position, most preferably within the cannabis industry. This position is another for which we may supplement our local staff with one or two key employees directly from other legal states. The Budtender Supervisor will oversee all Budtenders and Cashiers and will implement the training and education of all customer service staff. This staff member will have impeccable references and a clean criminal record in addition to excellent organizational skills and a proven management and customer service background.

**Inventory Manager & Buyer:** The Inventory manager will be responsible for maintaining the Inventory portion of the POS system selected by the Board and implemented by the GM. In addition, the Inventory manager will ultimately be responsible for the research and selection of Louie Gouie's dispensary inventory. This professional will work with a designated team of company staff comprised of supervisors and managers to research, train and vet products that will provide the widest array of available benefits to our anticipated clientele. In addition, the Inventory Manager will work with the GM to facilitate an established purchasing budget and will scrutinize and select vendors based upon company standards. Additionally, this manager will oversee the inventory control team and ensure complete compliance of all inventory records, producing them upon request as necessary.

**Inventory Control Team:** The Inventory Control team will carry out the requests of the Inventory Manager in addition to stocking and assisting with inventory reconciliation, securing inventory at the close of business each day and monitoring inventory throughout all shifts. These staff members will be on call for the cashiers to retrieve products requested by consumers for purchase. Inventory Control Staff will have previous inventory management or commensurate experience, be interested and familiar with the cannabis industry and pass a criminal background check and fingerprinting to be considered for the position.

**Budtenders & Cashiers:** A fully staffed Louie Gouie's dispensary floor will contain a mixture of Budtenders and Budtender supervisors at a ratio of 3:1. Cashiers will be stationed at counters and spaced conveniently so as to allow several customer transactions to be completed at one time. Budtenders will be responsible



for assisting and educating each visitor as needed based on their questions and concerns. Each Budtender will be adequately trained to understand the variety of medical and recreational needs experienced by consumers and to respond with a knowledgeable and helpful demeanor. Both the Budtender and Cashier positions will be eligible for upward mobility and promotion to the Supervisory position.

**Dispatchers:** Our delivery service will require one or more dispatchers per shift to handle incoming delivery requests via phone, text, email, and our website. The dispatcher will be responsible for reviewing the customers credentials if they are not already in our employee and customer register, processing the transaction including collection of payment, preparing the order in an opaque and sealed package as required by state law, and dispatching one of our delivery drivers to make the delivery.

**Delivery Drivers:** Delivery drivers will be responsible for assisting the dispatcher with order preparations, securely driving the order to the customer's address, verifying that the person receiving the order is the one who placed the order, and collecting payment if not already done so by the dispatcher. We have included specific standard operating procedures for how delivery drivers will carry out deliveries in our merit-based application submittal.

**Security Manager:** The Security Manager will work with the GM to implement the Security plan commissioned by the Board of Directors. This professional will have proven management skills and be expertly trained in all aspects of Security and leadership. Preference will be given to applicants whose background includes experience in the cannabis or related industries. Our Security Manager will be responsible for interviewing and training security personnel and developing the culture of friendly, firm and responsible management of the premises exterior and interior. This manager will schedule all security shifts and will ensure coverage at all times both by patrol and a consistently monitored and active surveillance and security system. They will also be responsible for developing and implementing a proven verification system to ensure that only authorized visitors will be served on the premises. This position will work with outside security monitoring personnel and agencies to ensure complete and consistent coverage in all situations, and to maintain strict compliance with all regulations existing and new. Security surveillance records will be maintained by this manager for a minimum of 45 days and will be produced upon request of authorized enforcement personnel.

**Security Personnel:** Security personnel will have a minimum background in security services with a preference given to those who have secured cannabis retail operations with proven results. This team of professionals will work together to achieve a total awareness of the premises at all times. A team hierarchy will be in place, with several members in communication with the Security Manager throughout the day. These professionals will be trained to manage a variety of situations including but not limited to: robbery, harassment, parking congestion, removal of intoxicated or uncooperative persons, safety of inventory and attendance to the security of customers entering and exiting the premises. The culture of the security personnel will be a team in constant communication and vigilance of the safety of all on the premises, and this culture will be developed and supported by the Security Manger.

**Accounting & IT Manager:** This position will be filled by a professional with the experience to manage the accounting and technological systems of POS, Track & Trace, CRM and any other information tracking system implemented by the Board. The Accounting & IT Manager will maintain a budget with the ability to outsource necessary services such as IT, Accounting, Marketing and other necessary teams of



consultants to ensure a fully functioning and consistently compliant operation. This position will require a degreed professional with proven management and communications experience. Preference will be given to applicants with a proven history of maintaining compliance in cannabis or related industries. This manager will work closely with the GM and other managers in the maintenance and daily operation of all of the facility data metrics and tracking systems.

As the success of our business will ultimately rest on our ability to safely and securely operate and comply with the wide range of laws governing our business, we have identified three areas of focus that are not apparent to the public:

- **Security** – A review of our Security plan and standard operating procedures demonstrates that we will be implementing a healthy combination of technology and human efforts to keep our patient/customers, employees, products, and cash safe and sound. Our security team members will be trained on providing support for our guests in an orderly, safe manner while at the same time, remaining very much in control of the environment both inside and outside our establishment. They will work with local law enforcement to ensure that everyone is kept safe and our surrounding community is not impacted negatively by our presence.
- **Accounting and Record Keeping** – With the help of the software mentioned above and the state-issued METRC inventory control, our financial software and many manual processes such as Audits and inventory transfer ledgers and logs, we will be tracking, tracing and compiling a very large amount of data that will be needed to ensure that we are able to produce the documentation required to keep our license and satisfy the needs of the City as they review our progress. We will enlist the help of several independent professionals to develop these controls and either hire or subcontract as needed to run these systems.
- **HR & Compliance** – Since California’s set of laws was just published and at the time we are submitting this application still remains only Emergency provisions, we are doing our very best to stay on top of what will be required of state licensed operations. If we are chosen by the City of Santa Rosa to begin implementation of our dispensary, we will hire the necessary professionals qualified to assist us in ensuring that we are operating in full compliance with all applicable state and local laws. This includes for example displaying a copy of our issued State License, Seller’s Permit, OSHA compliance, and other required employee notifications in prominent locations within our dispensary.

Together as a team, we will deliver on our promise to the community to provide a safe, secure environment in which our patients and customers can learn about the cannabis plant and experience the wide array of benefits it provides those of us in need of relief, all while meeting our corporate mandates to make a profit, record every detail of our transactions, and comply with every applicable law.

#### *Business License Type and Responsibilities*

With this application we are applying for both Medical and Adult Use conditions from the City. Upon approval, we plan to submit our state application for Type 10 Storefront Retailer licenses both Medical (M) and Adult Use (A) designations. This license and the conditions under which we will operate, including multiple sections related to our delivery service, is found in the California Bureau of Cannabis Control’s (BCC) comprehensive set of Emergency Regulations in Title 16, Division 42 of the CCR. With this license type for storefront retail, the BCC indicates in their regulations that we may also operate a delivery service





out of our location without the need for a Type 9 delivery only license. Our compliance protocol is described in detail in section 3 of this application.

Upon receipt, our state license will be prominently displayed in the lobby of our licensed dispensary where it can be viewed by state and local agencies per CCR 5039. As Louie's Gouie's does plan to maintain dual state licensing for the retail and delivery of both Medical (M) and Adult Use (A) Cannabis products, we have designated a clear separation within our retail sales and storage areas for the classification of Medical and Adult Use products. Inventory tracking procedures will handle (M) and (A) products as separate inventory databases

*Daily Cannabis Retail Operations*

*Product Sourcing - Common to Both Storefront and Delivery Channels*

As we are supplying cannabis products through both a retail storefront and via delivery service, we will start the discussion of our Operations with those elements that are common to both channels. The most important aspect of this being of course, product selection and sourcing.

Our Product Purchasing Process is outlined in Flowchart 2 below. The management first identifies a Licensed Distributor through a process of verifying regulation compliance and vetting positive reviews. When the selection process is complete, the sales department for that Distributor is contacted and a meeting scheduled with the Sales Representative. The management team will repeat this process with several Distributors, obtaining enough data for a reasonable analysis to select only the best vendors for our company.

**Flowchart 2**

**Product Sourcing**

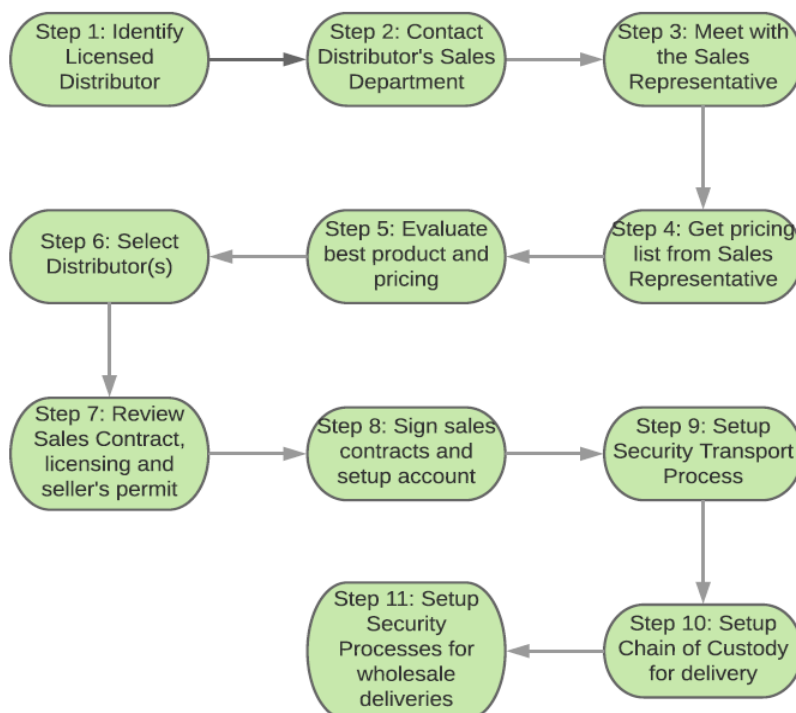



As a function of meeting with the Sales Representative of various Distributors under consideration, our management team will obtain cost lists and evaluate to select the most optimal products and pricing for our consumers. Upon completion of this process the management team selects the necessary Distributor(s) and initiates a sales contract and compliance measures for required licensing and permits. After completion of the sales contracts and account setup, the security transport process for the Distributor to deliver products to the licensed premises will be determined, and the Chain of Custody structure put in place. Finally, the security processes for wholesale deliveries will be implemented and the Distributor will be ready to deliver products to our company as a vetted and dedicated supplier.

*Retail Storefront Channel*

As our community will be most visibly impacted by our storefront operation, we want the City to be very comfortable with how our operation will function and be staffed. Section 4 of this document handles the physical layout of the facility, but from a patient/customer vantage point, their visit will occur as the Sales and Service Process Flowchart (3) below indicates, all according to a well-planned and trained-for experience.

**Sales and Service Process (3)**

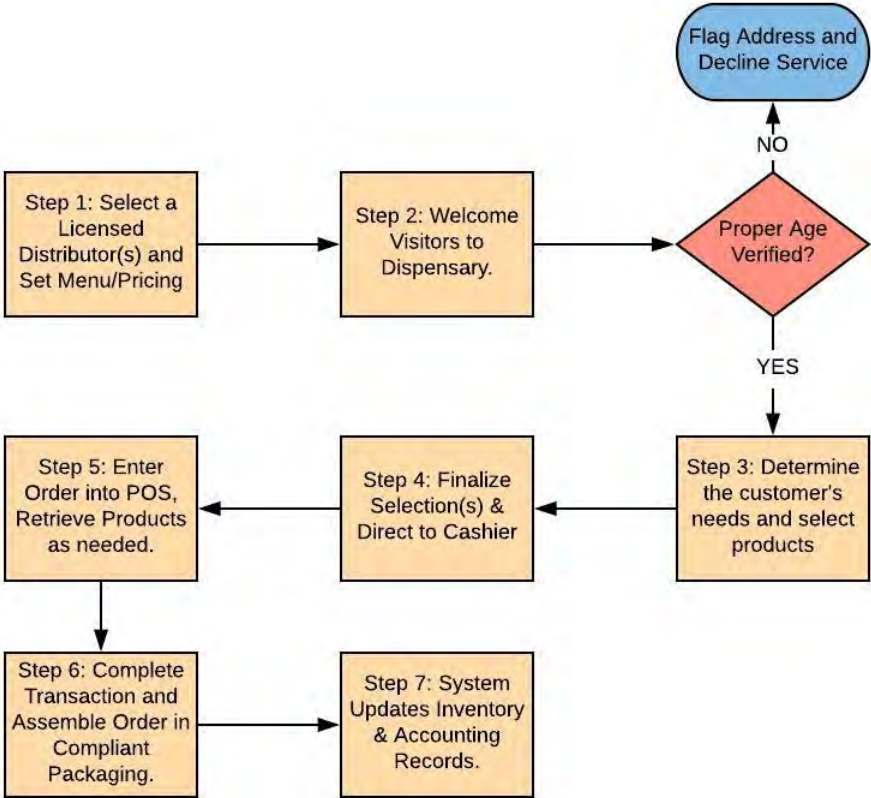





Visitors will be greeted, first by welcoming Security Personnel, then by a guest-relations professional, similar to the hostess at a restaurant. The guest-relations professional will verify the consumer's legal age and name by reviewing their government-issued ID. New visitors will be asked to complete a registration form and will be added to our database. Once verification has been completed, visitors will be invited to enter our showroom.

From the second a prospective patient/customer enters our showroom, we want them to feel welcome, safe, and at ease. We recognize that a great number of our guests will be coming to our dispensary for the first time, in great need of education, and will not appreciate any sort of high pressure sales environment. Our team will operate in a manner that puts customer education before revenue, knowing that if we answer all their questions honestly and to the best of our legal ability, a sale will result if our products can be helpful. Customers will be greeted by our friendly Budtenders and offered a tour of the product selection. The culture of our Budtenders will be casual but professional and both helpful and educational. At high volume times, guests will be prioritized, and served in the order we receive them.

By implementing well planned standard operating procedures, our dispensary will be able to educate customers and complete transactions quickly and efficiently. Streamlining customers will have the added benefit of minimizing any parking issues and vehicle queues. By separating the functions of cashiering from product education and sales, we will effectively use our staff to provide a flow of services that keeps customers busy from the time they arrive to the time they leave the premises. Visitors who must await service due to larger volumes of customers will be engaged by monitors offering insightful and educational information about cannabis and its many benefits.

When all of the customer's questions have been answered to their satisfaction and they are ready to make a purchase, the Budtender will escort them to the Cashier station where they will be attended by a cashier and an Inventory Control Staff member who will retrieve the desired products. Upon completion of the transaction, the customer will receive their items in properly compliant packaging that is certified child resistant and achieves appropriate depth and opacity such that purchased items are no longer visible. Once the transaction is complete, the Cashier will package the items in compliant exit packaging and make sure our guest is completely satisfied.

#### *Delivery Sales Channel*

The Operations Workflow Flowchart (4) describes the established flow of work from the beginnings of inventory to the final delivery and return of the driver to the operation as required by law. The process demands that Distributors be established prior to Delivery Workflow beginning. Step 1 is concerned with receiving inventory from Distributors and creating an inventory list and menu on our website with appropriate pricing. The team is then ready to receive Inbound calls from consumers.

Our first concern as we begin to assist consumers is that we are serving only those who can be verified as 21 years or over, or 18 years if they are a medical patient. For consumers requesting cannabis under the Medical use provision, forms of identification will be verified both by visual inspection and by online or telephone verification of the doctor who authorized the patient. Many companies issuing medical recommendations have an established online process that is quick and easy. If the consumer cannot produce a valid ID or necessary documentation related to their request, service will be refused and they



will be added to a list of ineligible consumers maintained by the delivery team and supervised by management.

Once the consumer is verified, they are contacted to establish their first order. Consumer needs are evaluated by staff and a variety of products are recommended for selection which can meet their usage requirements. When the consumer has made their selection, the order is finalized and a delivery time established. The staff member will then compile the required delivery paperwork and assemble the necessary products to complete the order. The delivery is then assigned to a driver for immediate release or added to the calendar for later delivery according to the consumer's scheduling needs.

**Flowchart 4**  
**Operations Workflow**

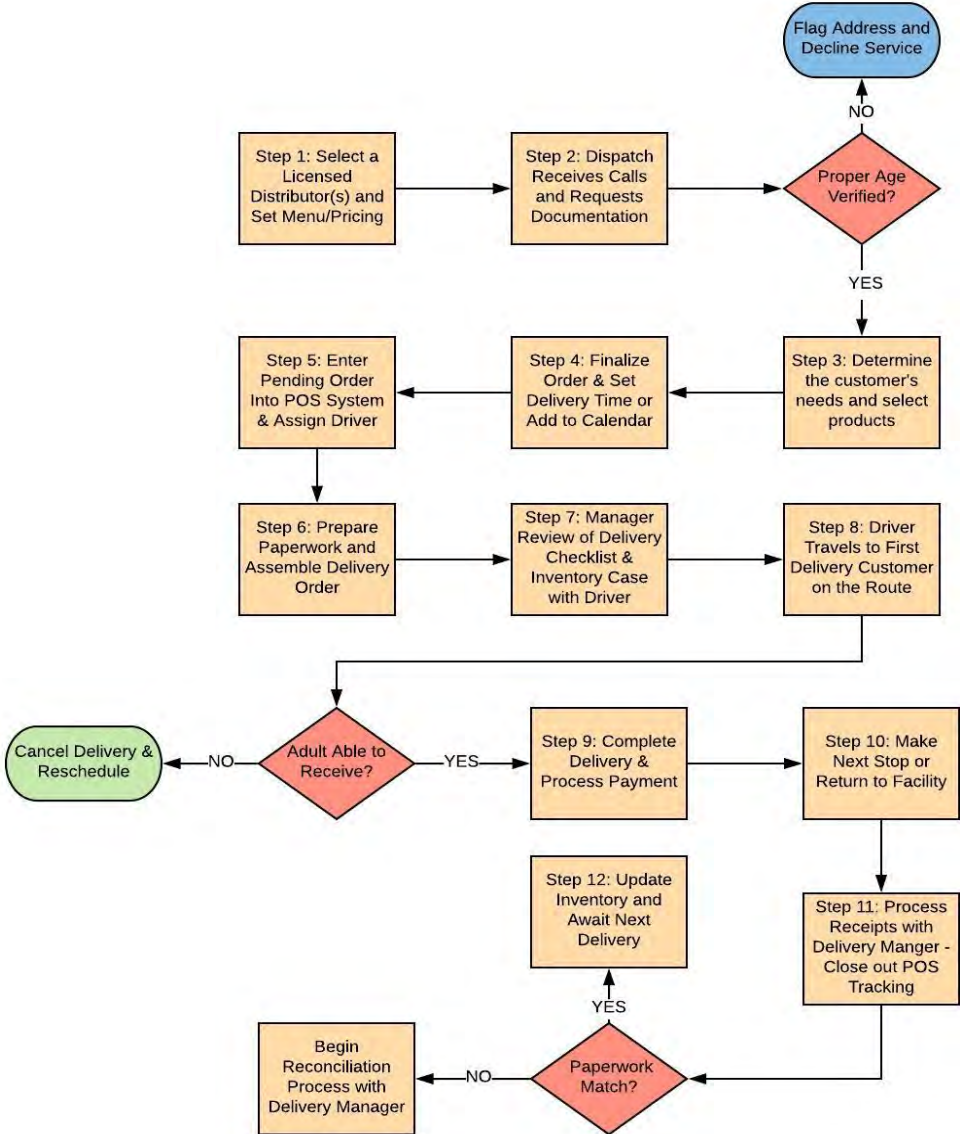



When the driver is released for delivery, their first step is to complete a vehicle safety inspection and to place all orders in the secured lockbox found inside of each delivery vehicle. Once the vehicle is secured, the driver will text their ETA to the consumer and begin their route. If the consumer is available to receive the order, their identification is verified, and the payment processed. The consumer receives a copy of the receipt and the original is retained by the driver. Cash received is placed in a small discreet lockbox inside the delivery vehicle for secure transfer back to the facility. If the consumer is not available to receive the order, the delivery will be canceled and rescheduled to a more convenient time.

Upon completion or cancellation of a delivery, the driver will continue to the next scheduled stop. When all the scheduled stops have been made, the driver will promptly return to the facility and transfer all cash to the safe designated only for delivery receivables. This safe will be monitored at all times and its contents transferred to a financial institution daily at several unscheduled times to keep the available cash on site at a minimum. Following transfer of receivables to the safe, the driver will then match the delivery paperwork to facility records for both the consumer and inventory. The paperwork is considered complete and processed when inventory is reconciled, and all paperwork matches facility records. Should a mismatch occur, the driver will begin the company reconciliation process with the COO.

Deliveries will be made during our normal hours of operation which are established as 9:00am to 9:00pm Pacific Standard Time per City regulations. Our initial fleet will consist of three vehicles owned by the company or owners of the company. These vehicles meet company standards detailed in Section 5a and comply with regulations stipulated throughout section three, namely; they are all fully covered by insurance and are each outfitted with a dedicated GPS device affixed to the vehicle. Our company-owned GPS system can identify the geographic location of all vehicles on the delivery route at all times. When not in use for delivery, vehicles will be parked and secured on the facility premises.

We estimate an initial need of up to three available drivers throughout each business day. To meet the anticipated demand, we plan to initially hire four to five drivers who will be trained for delivery per company standards as well as in compliance with local and state regulations. Drivers are expected to make no more than seven to ten delivery trips each business day in the company vehicle.

#### *Hours of Operation*

In accordance with local ordinance, we will be open for business from 9:00am to 9:00pm daily. Personnel will be on-site both before and after these hours preparing for business and closing down for the day.

#### *Monitoring and Prevention of Diversion*

Louie's Gouie's ownership is privileged to apply for the right to operate a marijuana facility and understands there are considerable risks in operating a marijuana business. Those risks include potential burglaries and theft by outside parties, product diversion by both employees and customers, risk of minors accessing product, and risk to the safety of our employees. Our company is committed to ensuring a safe environment that mitigates as much risk as possible. Risk mitigation includes, but is not limited to, implementing the security requirements as mandated by all state and local laws, including the roles set forth by The City of Santa Rosa Municipal Code Section 10-40.110. In addition to ensuring the safety and security of its employees and customers, Louie's Gouie's accepts responsibility for safeguarding against the theft or diversion of any marijuana items, and any records, be they in hardcopy documents or in digital form.



#### A4. Management Plan

Recognizing and honoring the city's culture is the foundation for our proposal. As long-time stakeholders in the future of Santa Rosa's economy, we recognize that the land use restrictions on cannabis dispensaries ensure that these proposed businesses do not impose negative impacts on the neighborhoods in which they are established. Our chosen location is mostly surrounded by commercial land uses.

##### *Nuisances*

Our considerations of the neighborhood and its residents have helped us contemplate the most efficient ways to minimize nuisances like security concerns, and additional foot and street traffic in unwanted areas. As we are consistently compliant with state and local regulations, we also plan to maintain the active presence via security patrols and video surveillance in and outside the premises, that are both required by state and local laws and upheld by our good business practices. In addition to fulfilling security requirements, our staff will contribute to the safety of the neighborhood by helping to deter local crime through discouraging loitering on the property and on adjacent properties, in nearby public areas, and in surrounding neighborhoods.

According to our industry experts, a search of 1,000 feet surrounding our future property for the previous year (June 15, 2017-June 15, 2018) revealed 42 crime reports. Noncriminal activities accounted for 31% of the reports during this period while drug and alcohol related incidents accounted for 16%. We intend for our presence to be a benefit to the community in many ways, including the increase of safety and security. Beyond our efforts to collaborate with local law enforcement in the deterrence of criminal activity, we plan also to participate with local police and nearby fire department to promote public education and awareness on safe cannabis use and to provide consumers with local emergency contact information that could aid in increased reporting.

##### *Waste and Debris*

As noted in our Waste Management Plan, we will contract with a licensed and professional cannabis waste management firm to properly and legally dispose of any cannabis our operation generates from product displays, returns or other activities that render cannabis not saleable. We will also work to ensure our property is regularly maintained to provide a clean and attractive exterior. Our onsite security personnel will be responsible for making sure that trash and debris are quickly cleaned and any maintenance issues are reported and mended. On a weekly basis, our compliance specialist will also be responsible for checking the property for any litter, debris, or other issues and making sure issues are remedied quickly.

The property exterior has already been significantly improved compared to its previous appearance (as shown in the Photo Plate attachments). We will continue to make exterior improvements to benefit the immediate premises and the surrounding area by trimming and updating existing landscaping on the expansive grounds, removing fences, barbed wire and trash, and improving the aesthetics of the area through these efforts. We wish to create an inviting atmosphere that resonates a sense of safety and welcoming community spirit.



*Community Engagement*

It is important to us to develop connections with community members and support the neighborhood surrounding our business. We also want to ensure that community members can contact us regarding any issues or concerns. To this end, we will work hard to regularly engage with community members through various methods. Our business website will have a contact page with all of the relevant contact details (phone, email) to allow community members to reach us with any questions or concerns. We will prepare a quarterly newsletter that will provide any updates to the business and community and will hand out this newsletter in the neighborhood (and provide electronically to those interested) to keep the community apprised of our activities and how we are working to continue to improve the area. Our owner Luis Chavez will take on the responsibility of handling all neighbor questions, comments, and concerns and ensure they are satisfied. Our primary goal is that neighbors stay happy and the city is relieved of any possible complaints.

Finally, once a year we will host an open house to allow community members to visit the business and learn more about our operations and the work we are doing in the community. All security protocol will be followed in providing access to the premises for the open house. We hope that this event, along with other community engagement efforts, will work to develop long-term positive relationships with neighboring businesses and residents and will contribute to the community spirit of Santa Rosa.

**A5. Performance Timeline**

In anticipation of our approval, we have already taken possession of the premises in which we will operate and could quickly complete the renovations we have discussed in this application. We anticipate completing this remodeling within 30-60 days of City approval and being open by year's end.

***Gantt Chart of Approvals and Build Out***

Task	2018			
	Q2	Q3	Q4	
City Review	█	█	█	
City Approval		█		
Entitlement		█	█	
Build-out		█	█	
Certificate of Occupancy			█	
State Temporary License Process		█	█	
State Annual License Process			█	█
Begin Operations			█	█



## B. Regulatory Approvals & Compliance

Louie's Gouies Dispensary will be operated in full compliance and consistent with all applicable local and state regulations. We have provided the following discussion on those specific regulations, codes, and policies identified as relevant in the City of Santa Rosa's cannabis application requirements.

### B1. State of California Cannabis Licensing

The State of California began issuing licenses to cannabis businesses in January 2018. The City of Santa Rosa's moniker for our business type "Cannabis Retail (Dispensary) and Delivery", is referred to as a Type 10 Storefront Retailer in the state's Bureau of Cannabis Control (CCR) regulations, Chapter 3, Section §5400, and further defined in BPC section 26070-26070.5.

State regulations require that cannabis for medical or adult-use must be licensed under separate Type M or Type A licenses. Our local delivery-capable dispensary plans to apply for both license types and recognize the restrictions in the supply chain, inventory tracking, and financial reporting that will eventually be flushed out by state law in this area. Our deliveries plan to operate only one location presently with a service area that can expand over time. Licenses are issued for 12 months, requiring annual renewal, and are not transferable. Louie's Gouie's is ready to comply with all state regulations including but not limited to the following list of highlights:

#### § 5400. Access to Retailer Premises

- Our dispensary is applying for both an (A) and (M) license from the state and will be prepared to verify both age by government-issued ID and Medical Use through an established verification system for Medical Recommendations. Only consumers 21 years of age and older will be admitted for purchase of adult-use cannabis or cannabis products and those aged 18 years or older with a valid recommendation for Medical use.

#### § 5401. Limited Access Areas

- Our facility is designed to comply with this section by identifying limited-access areas accessible by only authorized individuals and protected by both security equipment and keycard access for approved personnel of the facility. A log will be maintained of all visitors to the facility who are not employed and who have been verified as being 21 years of age or older. Each visitor will be given a temporary badge and escorted to the authorized area of the facility by a manager or authorized personnel with adequate security clearance. No compensation will ever be considered in exchange for admittance to the facility or restricted-access areas. Company Standard Operating Procedures have been drafted to address this and all other issues of state compliance.

#### § 5402. Retail Area

- The owner or at least one employee will be in either the lobby or sales area with visitors at all times. Individuals will not be granted access to the facility until they have verified their authorization to consume cannabis through presentation of a current and valid government-issued ID or other compliant identification, and a current and valid recommendation from a State-licensed practitioner. Our facility will use a digital verification system that verifies records with the state's online database to ensure proper and complete verification of all visitors entering the facility.





#### **§ 5403. Hours of Operation**

- Louie's Gouie's will maintain hours of operation consistent with local regulations as 9:00am – 9:00pm in preference to the state regulated operation hours of 6:00am to 10:00pm. Changes to operating hours will be in accordance with changes to local governance. During inactive hours, the dispensary will be secured by surveillance and security equipment, alarm and security monitoring in accordance with all regulations and security concerns expressed by state and local governments. We provided our Security Plan along with this application for your complete review.

#### **§ 5404. Retail Customers**

- All retail customers will be verified according to strict age and identification requirements and in compliance with section 5402.

#### **§ 5405. Cannabis Goods Display**

- Any cannabis goods intended for inspection and sale will only be displayed in the retail area and will not be visible from outside the licensed premises. Customer service personnel may remove cannabis from existing containers to a separate container for inspection by the customer and will remain with the customer for the duration of the inspection. Any cannabis product that has been removed from its display will not be sold or consumed and will be destroyed according to section 5054.

#### **§ 5406-5408. Cannabis and Non-Cannabis Goods for Sale**

- Only cannabis goods received from a licensed distributor and verified as not expired and in compliance with all requirements of Business and Professions Code section 26130 and all other relevant laws will be made available for delivery to a verified customer. Although the state has authorized the sale of non-cannabis products under certain circumstances, Louie's Gouie's will adhere to the local regulations prohibiting such sales and will not retail any non-cannabis products, nor will we possess or sell live plants at our facility.

#### **§ 5409-5410 Daily Limits and Customer Returns**

- Louie's Gouie's limits its purchases for any customer to no more than 28.5grams of non-concentrated or 8grams of concentrated cannabis per customer per day. We will comply with all additional state and local regulations and standards pertaining to this section.
- If a customer returns cannabis product, they will be sealed in a designated waste receptacle and disposed of in a manner consistent with our company policies and procedures and compliant with all regulations of section 5410.

#### **§ 5411. Free Cannabis Goods**

- Louie's Gouie's engages from time to time in donations of cannabis under the compassionate use standards of California and will continue to do so in strict compliance with this section. No cannabis will be donated to any person not verified or in possession of the proper authorization and identification. All donated cannabis will be recorded in the track and trace program, be tested, and



compliant with all standards of retail cannabis and will be applied toward the consumer's daily limit upon receipt.

#### **§ 5412-5413. Packaging, Exit Packaging & Labeling**

- Louie's Gouie's will not accept any packaging from a distributor that is not fully compliant with all packaging standards of these sections and other applicable state and local standards for Child and Tamper resistant cannabis packaging.
- All purchased cannabis goods will be placed in opaque exit packaging according to the standards of this section.

#### **§ 5414. Type 9- Non-Storefront Retailer**

- We will conduct retail cannabis sales exclusively by delivery as defined in Business and Professions Code section 26001(p) and in compliance with all the requirements applicable to Type 10-Retailer licensees, except for those provisions related to public access to the premises. In compliance with the Type 9-Non-Storefront Retailer license, the premises will be closed to the public.

#### **§ 5415. Delivery**

- All deliveries of cannabis goods will be performed by our employees.
- All of our employees will be at least 21 years of age.
- All of our deliveries will be made by drivers employed by the company and delivered in a company-owned or approved vehicle.
- We understand that by definition, our delivery process begins when the delivery employee leaves our licensed premises with the cannabis goods for delivery and ends when the delivery employee returns to our licensed premises after delivering the cannabis goods to the consumer(s).
- Our delivery employees will carry a copy of the current company license, their own government-issued identification, and an identification badge provided by us in accordance with state and local regulations during each delivery.
- A current and accurate **Employee Register** of all delivery employees will be maintained on the premises and available for inspection upon request.

#### **§ 5416. Delivery to a Physical Address**

- We will only deliver cannabis goods to a physical address in California.
- Our delivery employee will not leave the State of California while possessing cannabis goods during their shift.
- We will not deliver cannabis goods to an address located on publicly owned land or any address on land or in a building leased by a public agency, including land held in trust by the United States for a tribe or an individual tribal member, unless the delivery is authorized by and consistent with applicable tribal law.

#### **§ 5417. Methods of Delivery**



- Cannabis goods intended for delivery will be conveyed by our employees in an enclosed motor vehicle.
- Our delivery employees will not allow cannabis goods to be visible to the public during transfer to the delivery location.
- Our delivery employees will be trained in adequate safety measures according to standard policies and procedures. No delivery employee will leave cannabis goods in an unattended motor vehicle unless the motor vehicle is locked and equipped with an active vehicle alarm system.
- Vehicles used for the delivery of cannabis goods will be outfitted with a dedicated Global Positioning System (GPS) device which is owned and operated by the licensee. The GPS system will have the capability of identifying the geographic location of all vehicles owned and used exclusively by our companies for delivery. Tracking devices will be either permanently or temporarily affixed to each delivery vehicle and will remain active and inside the delivery vehicle at all times during delivery. Each delivery is equipped to respond quickly and accurately should the Bureau of Cannabis Control request tracking information pertaining to the location of any of our delivery's vehicles at any time.
- Upon request, we will provide the Bureau with information regarding any motor vehicles used for the delivery of cannabis goods, including the vehicle's make, model, color, Vehicle Identification Number, license plate number and Department of Motor Vehicle's registration information.
- We understand that impromptu vehicle inspections may be required by the bureau at the licensed premises or during delivery. To this end, facility staff and drivers are prepared per company policy, to comply with all such requests by the bureau.

#### **§ 5418. Cannabis Goods Carried During Delivery**

- At no time during delivery will our employees carry cannabis goods worth more than \$3,000. Company policy requires management staff to review with each driver, the contents of their inventory case, and a checklist of items the driver should have for the delivery route prior to each delivery. Value shall be determined using the current retail price of all cannabis goods conveyed during delivery.

#### **§ 5419. Cannabis Consumption During Delivery**

- In accordance with state and local regulations, as well as our standard company policy, our delivery employees are prohibited from consuming cannabis goods while either on the premises or in the process of delivering cannabis goods to consumers.

#### **§ 5420. Delivery Request Receipt**

- We will comply with all regulations in the preparation of a delivery request receipt for each delivery transaction. Each receipt will contain the following:
  - The name and address of the retailer;
  - The first name and company-issued identification number of the employee who delivered the order;
  - The first name and company-issued identification number of the employee who prepared the order for delivery;
  - The first name of the consumer and a retailer-assigned consumer number for the person who requested the delivery;

- The date and time the delivery request was made;
- The delivery address;
- A detailed description of all cannabis goods requested for delivery. The description will include the weight, volume, or any other accurate measure of the amount of all requested items;
- The total amount paid for the delivery, including any taxes, fees, the cost of the cannabis goods, and any other charges related to the delivery;
- The date and time the delivery was made, and the signature of the consumer who received the delivery;
- After the consumer has signed for delivery, our delivery employee will provide them with a copy of the delivery request receipt, retaining the original for company records.

#### **§ 5421. Delivery Route**

- While making deliveries of cannabis goods, our employees are instructed to travel only from the licensed premises to the delivery address; from one delivery address to another delivery address; or from a delivery address back to the licensed premises. Our delivery employees will not deviate from the delivery path described, except for necessary rest, fuel, or vehicle repair stops, or because road conditions make continued use of the route unsafe, impossible, or impracticable.

#### **§ 5422. Receiving Shipments of Inventory**

- In compliance with state regulations and company policy, our shipments of cannabis goods for inventory will be received only from a licensed distributor.
- Any shipments of cannabis goods will be received only between the hours of 6:00 a.m. to 10:00 p.m. Pacific Time.
- During business hours, shipments of cannabis goods will not enter the premises through an entrance or exit that is available for use by the public.

#### **§ 5423. Inventory Documentation**

- Our companies will maintain a current and accurate record of inventory which will track cannabis goods both on the premises and out for delivery at all times. Upon request, we are prepared to furnish records of inventory to the Bureau. The following list of information will be kept for each inventory item:
  - An easily identifiable description of each inventory item;
  - An accurate measurement of the quantity of the item;
  - The date and time the cannabis goods were received by the retailer;
  - The sell-by or expiration date on any cannabis goods, if any;
  - The name and license number of the licensee that delivered the cannabis goods to the retailer;
  - The name and license number of the distributor that provided the cannabis goods to the retailer;
  - The price the retailer paid for the cannabis goods, including taxes, delivery costs, or any other costs;

#### **§ 5424. Inventory Reconciliation**



- In compliance with state regulations, our delivery businesses will implement the following steps to ensure adequate inventory tracking:
  - A reconciliation of inventory will be performed by a company manager on a bi-weekly basis.
  - The inventory manager will verify that the physical inventory matches the facility's inventory records.
  - All records of inventory reconciliation will be maintained on site and available to the Bureau upon request.
  - If any evidence of theft, diversion or loss is identified, the inventory manager will notify the Bureau and law enforcement in accordance with Section § 5036 of the CCR.
  - If a significant discrepancy as defined in Section § 5034 of the CCR is discovered between our company's physical inventory and the inventory records, our inventory manager will notify the Bureau and law enforcement in accordance with Section § 5036 of the CCR.

## B2. County and Regional Permits

Louie's Gouie's will obtain a Sonoma County Health permit, if applicable, and comply with Health and Safety Code Section 13700 et seq. and Sonoma County Health permit requirements in order to sell retail edible cannabis products at our dispensary.

## B3. City of Santa Rosa General Plan

The proposed dispensary is in line with the City of Santa Rosa's General plan as we seek to preserve the existing building and improve the grounds to create a business that is easily accessible by local pedestrian traffic. The General plan states its desire to promote the use of alternative transportation modes and discourage travel by automobile which is one of the positive benefits that the improvements to the grounds of 316 Yolanda will provide the city. Additionally, Louie's Gouie's operation will support the general plan in all of the following ways:

- Landscaping and improvements – the improvements to the premises around the dispensary will promote the quiet and safe flow of traffic and a higher degree of visual transparency enhancing the safety of the area;
- Connections – our local dispensary will enhance the connectedness of the local area by adding a valuable service that will be accessible to a wide variety of authorized clientele and add to the neighborhood character;
- Preservation of natural features – by preserving the existing and mature trees around the lot and removing unsightly sheds, vehicles, fences and ground cover, our operation will greatly improve the aesthetics of the area while preserving the home and existing natural features of the site;
- Diversity and Choice – Our dispensary will also contribute to the City's desire to create choice for residents with different values by offering a variety of products that suit the needs of a wide range of customers.
- Our proposed site is less than a quarter mile from the nearest public transportation stop and within walking distance of several food and retail stores.

## B4. City of Santa Rosa Municipal Code

Louie's Gouie's is proposing to locate its operations in a newly remodeled dispensary at 316 Yolanda Avenue in the City of Santa Rosa. Our secured premises, developed to accommodate the expected workflow that will be guided by our policies and procedures currently under development, are designed



to comply with all rules and regulations specified by state and local agencies. Louie's Gouie's intends to successfully acquire and maintain its licensure in good standing and to demonstrate the Company's commitment to exemplary compliance.

As a cannabis-based business, we intend to align with Ordinance No. 2017-025 of the Council of the City of Santa Rosa Costa relating to Licenses and business Regulations. Chapter VI governs cannabis businesses lawfully operating in the City of Santa Rosa and as such, we are here giving special focus to, Ch VI., Section 20-46.080, Cannabis Retail (Dispensary) and Delivery to demonstrate Louie's Gouie's intentions to comply.

20-46.010. Purpose and intent.

- We recognize the right and responsibility of the City of Santa Rosa to protect the health, safety, and welfare of its residents in general and specifically with regard to the marijuana or cannabis industry and products, and to enforce rules and regulations consistent with state law. In acknowledgment of this right and responsibility, Louie's Gouie's respectfully seeks a permit to operate a medical marijuana business within the city.

20-46.020. Limitations on Use

- Louie's Gouie's will comply with Resolution 2017-035 and the accompanying Cannabis Industry Tax Ordinance by submitting the required sworn statement and paying the annual fees in connection with registration of a Cannabis Business. In addition, Louie's Gouie's will remit the required quarterly taxes of 3% for its Adult Use retail sales and 0% for its Medical retail sales and comply with all applicable reporting and compliance standards set forth in the resolution and ordinance. Louie's Gouie's pledges to remain in consistent compliance with all State and Local regulations governing the sale and distribution of cannabis.

20-46.040. Cannabis Businesses

- Louie's Gouie's is located in a commercially zoned area with no nearby school or other sensitive use locations within a 600' radius. Land Use and Developmental standards outlined in Divisions 2 & 3 of the Site Planning and General Development Regulations along with the City Code will be adhered to completely unless a conflict between the requirements of Chapter VI - Cannabis, and those of Divisions 2 & 3 arises. In the case of such a conflict, Chapter VI stipulations will control.

20-46.050. General Operating Requirements

*Dual Licensing & Permitting Requirements*

- Louie's Gouie's intends to comply with all requirements outlined by the state and local governments including dual state and local permitting. We intend to apply for a state Medical Use (M) and Adult Use (A) permit in connection with the approval of our Conditional Use Permit request as an Operator in good standing.
- In addition to state and local licensing, the operation will obtain all required permits including Building and Fire permits confirmed with the appropriate occupancy classification and in compliance with Chapter 18 of the City Code. All annual operating fire permits will be obtained prior to the commencement of operations. The dispensary will comply with all applicable H&SC and California Fire Code requirements related to storage, use and handling of hazardous materials and generated hazardous waste and will obtain all additional required permits prior to opening. The local Fire Department will be provided with a lockbox for keys to all gates and doors.



- Louie's Gouie's does not intend to transfer dispensary ownership but in the event of such occurrence, will follow all required processes including the acquisition of a zoning clearance.
- As Louie's Gouie's does plan to maintain dual state licensing for the retail and delivery of both Medical (M) and Adult Use (A) Cannabis products, we have designated a clear separation within our retail sales and storage areas for the classification of Medical and Adult Use products. Inventory tracking procedures will handle (M) and (A) products as separate inventory databases

#### *Compliance with Laws & Prohibition of Minors*

- We recognize our responsibility to ensure that we are always operating in a manner compliant with all applicable state and local laws, and any regulations promulgated thereunder. Specifically, as it applies to minors, our operation is committed to ensuring the prohibition of minors on or around our premises. A person is considered a minor if they are under the age of 18 years and do not have a valid, state issued Medical Cannabis card or, if they are under the age of 21 years and not authorized to consume Medical Cannabis.

#### *Security measures.*

- We will implement sufficient security measures to deter and prevent the entrance of unauthorized persons into areas containing medical cannabis or medical cannabis products, and to deter and prevent the theft of medical cannabis or medical cannabis products at the medical marijuana business. These security measures include:
  - Establishing limited-access areas accessible only to authorized personnel or escorted visitors over the age of 21;
  - Storing all medical cannabis and medical cannabis products in a secured and locked room, safe, or vault in a manner that prevents diversion, theft, and loss;
  - Installing sensors and Building Code compliant commercial-grade, non-residential door or window locks on all points of ingress and egress to detect and/or prevent entry and exit;
  - Having a professionally installed, maintained, and monitored alarm system;
  - Having security bars on the windows or the doors, as needed only on the interior of the building;
  - Ensuring that any security personnel utilized will be licensed by the State of California Bureau of Security and Investigative Services Personnel; and
  - Maintaining the capability to remain secure and operational during a power outage and ensuring that the integrity of all access doors and electronic locks remains.
  - Implementing Standard Operating Procedures for safe and secure transportation and delivery of Cannabis, Cannabis Products and currency in accordance with state law.
  - Establishing best management practices and technologies for reducing glare, light pollution and light trespass onto adjacent properties. Exterior lighting will provide illumination and clear visibility to all outdoor areas of the premises including all points of ingress and egress. The operation will comply with all additional requirements of Chapter VI, Section 20-46.050 with regard to both exterior and interior lighting.
- We identify Louie's Gouie's Owner Luis Chavez, as the designated security representative/liaison to the City. Luis will be reasonably available to meet with the city's CEO regarding any security related measures or operational issues.
- The Louie's Gouie's Owner will be notified within twenty-four (24) hours of the discovery of any of the following:



- Significant discrepancies identified during inventory, as set forth in the city's administrative regulations;
- Diversion, theft, loss, or any criminal activity involving Louie's Gouie's or any agent or employee of our business; or
- The loss or unauthorized alteration of Louie's Gouie's records related to cannabis, cannabis products, or employees or agents of our business.

#### *Records and recordkeeping.*

- Louie's Gouie's intends to implement and maintain a state-compliant inventory control and reporting system that accurately documents the present location, amounts, and descriptions of all cannabis and cannabis products for all stages of the production or manufacturing, laboratory testing and distribution processes.
  - Subject to any restrictions under the Health Insurance Portability and Accountability Act (HIPPA), we will allow city officials to have access to our business's books, records, and accounts, together with any other data or documents relevant to our permitted medical marijuana activities, for the purpose of conducting an audit or examination. This information will be produced no later than twenty-four (24) hours after receipt of the city's request, unless otherwise stipulated by the city.
- We will maintain accurate accounting records, detailing all revenues and expenses of the business and all of its assets and liabilities. At least annually, (at or before the time of the renewal of a medical marijuana business permit issued pursuant to this title), or at any time upon reasonable request of the city, we will file a sworn statement detailing our number of sales per month during the previous twelve (12) month period (or shorter period based upon the timing of the request).
- We will establish and maintain an Employee register which contains the names, numbers and personal identification information such as, date of birth SSN and Vehicle Operating Licenses for each employee hired by Louie's Gouie's. Recording standards and file contents are discussed further in the Employment & Hiring practices of this Narrative;
- Felons will not be considered for employment by Louie's Gouie's and such applicant files as well as files of terminated employees will be maintained by the Human Resources manager who will establish a routinely updated list for the Security staff. This list will act as a reference list for security personnel and will be referred to each time a visitor or consumer is verified for entry to the premises;
- We will maintain and provide upon request, a current Employee Register, complete contact information (name, address, and telephone number), of anyone owning or holding an interest in Louie's Gouie's, and separately of all the officers, managers, employees, agents and volunteers currently employed or otherwise engaged by our business.

#### *Odor Control*

- We will incorporate odor control devices and techniques to ensure that odors from marijuana are not detectable off-site. Please refer to our Odor Control Plan.

#### *Noise*

- Louie's Gouie's will use only compliant ventilation and A/C equipment in accordance with the Chapter 17-16, Noise. Our operation will only use generators temporarily in the event of a permitted emergency to back up security and safety features of the facility as well as temporarily run our financial systems. Given the nature of our business as a retail operation, we anticipate our building noise to be lower than the ambient noise from Yolanda Avenue and the surrounding industrial buildings, including those between our business and nearby residential units to the south.





#### *20-46.080 Cannabis Retail (Dispensary) and Delivery*

- Louie's Gouie's is applying for the required Conditional Use and other required permits to operate a Cannabis Retail Dispensary at 316 Yolanda Avenue in the City of Santa Rosa. This dispensary is applying for both an M (Medical Use) and A (Adult Use) license from the State and a Commercial Retail and Delivery Service permit from the City of Santa Rosa.
- Louie's Gouie's intends to operate as a secured storefront dispensary with a permitted delivery service to provide a wider range of care for local cannabis users who are immobile or otherwise unable to go to a local dispensary. No walkup or drive-through services will be provided. A detailed description of our operations can be found in Section 5 of this Narrative.
- We have verified through certified professionals that our chosen dispensary location is not within 600' of recognized sensitive areas such as schools. The City has acknowledged the presence of two additional retail applicants within a 300' range of our intended operation and as such, we intend to demonstrate throughout this application, the value that we will provide the City and the local community over and above our competitors.
- The entrance to our storefront will be in a visible location, facing the street with unobstructed views from the public right of way as per City regulations.
- Louie's Gouie's will obtain a Sonoma County Health permit, if applicable, and comply with Health and Safety Code Section 13700 et seq. and Sonoma County Health permit requirements in order to sell retail edible cannabis products at our dispensary.

#### *Operational Requirements*

Louie's Gouies will comply with all stated operational requirements both in the state and local standards of the City of Santa Rosa including but not limited to:

- We will maintain adequate and complete records of sales, inventory, human resources (Employee Register), maintenance, security and any other records required by the City and will provide copies to the City or other authorized officials upon request and within assigned timeframes.
- We will have in place a point-of-sale or other inventory tracking and invoicing system to monitor and report on all aspects of our business including, but not limited to, such matters as cannabis tracking, inventory data, and gross sales (by weight and by sale). We will ensure that such information is compatible with the city's record-keeping systems and has the capability to produce historical transactional data for review by the city's CEO.
- We will have protocols in place to verify the identification of all staff and visitors that enter the premises. Persons under the legal age of consumption for medical or adult-use cannabis will not be allowed on site. Legal age will be verified by government issued photo identification and Medical recommendation for Medical users. No cannabis or cannabis products will be provided to persons not in possession of a valid government-issued photo identification card and where required, a valid physician's recommendation under Section 11362.712 of the Health and Safety Code.
- Our facility will run in compliance with the City of Santa Rosa's requirements, from the hours of 9:00am to 9:00pm seven (7) days a week unless the review authority imposes more restrictive hours due to particular circumstances of the application.
- Our facility will have established secured-access areas, accessible by keycard assigned to only authorized personnel. All products not used for display or immediate sale will be stored in a secured and locked room, safe, or vault within the limited-access area which is designed to prevent diversion, theft and loss.



- Any cannabis and cannabis products that are sold, distributed, or manufactured by our operation will be cultivated, manufactured, and transported by licensed businesses that maintain operations in full conformance with the state and local regulations. No cannabis related paraphernalia or any implement used to administer cannabis will be sold at our dispensary per City zoning codes and conditions of the CUP.
- Our site will be maintained according to strict operating policies and procedures in compliance with state regulations for site management including but not limited to; maintenance of exterior, mitigation of nuisances on premises and in parking and surrounding areas; and implementation of an emergency plan for contacting police or security.
- Louie's Gouie's does not intend to allow onsite cannabis consumption by employees or patients as permitted in Chapter 9-20 (Smoking Regulations). As such, we will prohibit consumption of cannabis products on our facility premises and by our employees elsewhere in the City through onsite signage and strict adherence to company policies and procedures.
- We will visibly post at each entrance, a clear and legible notice indicating that smoking, ingesting, or otherwise consuming cannabis on the premises or in the areas adjacent to the medical marijuana business is prohibited. We will not implement any business identification signage that fails to conform to the requirements of the city's code.
- Any signage we use will be limited to that needed for identification only.
- We will not allow cannabis or cannabis products or graphics depicting cannabis or cannabis products to be visible from the exterior of our property or on any of our vehicles owned or used as part of the business. We will not store any cannabis or cannabis products outside.
- We will post the original copy of our city-issued medical marijuana business permit and business license inside our business in a conspicuous location.
- We will ensure that every owner, manager, supervisor, or employee of our business submits fingerprints and other information deemed necessary by the city's CEO for a background check by the Santa Rosa Police Department, to verify that person's criminal history.
- Loitering outside of the facility by any person, either on the premises, or within fifty (50) feet of the premises, is prohibited.
- We will not cause or permit the sale, dispensing, or consumption of alcoholic beverages on or about our premises.

#### *Insurance.*

- We will obtain and maintain at all times during the term of the permit, comprehensive general liability insurance and comprehensive automotive liability insurance protecting us in an amount of not less than one million dollars (\$1,000,000.00) per occurrence, combined single limit, including bodily injury and property damage; and not less than one million dollars (\$1,000,000.00) aggregate for each personal injury liability, products completed operations and each accident, issued by an insurance provider admitted and authorized to do business in California and rated at least A:X in A.M. Best and Company's Insurance Guide.

#### 20.46-090 Cannabis Special Events

- Louie's Gouie's does not intend to hold or apply for any special events as a function of its operation.

#### 20-70.020 Section 7, Definitions

- This application and all of our materials and Standard Operating procedures are written in compliance with the current definitions outlined in the above-referenced Section of the City Code.





#### 20.46-100 Acknowledgement of Grounds for Permit Revocation or Modification

- Louie's Gouie's additionally acknowledges that our permit can be revoked upon a hearing by the city for failing to comply with the terms of the permit, the applicable provisions of city ordinances, state law or regulation and/or any condition of any other permit issued pursuant to this code, and such revocation will preclude us from operating until the matter is resolved.

#### Section 8 – Environmental Determination

- We recognize the stipulations adopted by the Council exempting ORD-2017-025 from CEQA review in certain circumstances not including the application for Conditional Use. Our present application will include all environmental considerations in more detail in the sections below to demonstrate our compliance with all requirements. We anticipate our project being categorically exempt under CEQA for minor land use modifications and other categories deemed appropriate by the City.

#### B5. Santa Rosa City Building and Fire Code

Our project is committed to following all applicable fire and building codes, including the following:

- California Building Code (2016 Edition)
  - Our improvements will include modify internal walls, exterior ADA ramp and railings, and other features. When applicable, we will apply for a building permit.
- California Plumbing Code (2016 Edition)
  - As a part of converting the building from its previous residential use, we will update the bathrooms to be compliant with ADA accessibility. All new fixtures will adhere to current Plumbing Code.
- California Electrical Code (2016 Edition)
  - When applicable, we will apply for a building permit for any electrical changes required to improve our property. This includes exterior lighting used for safety and security.
- California Mechanical Code (2016 Edition)
  - Our ventilation system will be updated to state of the art components, all of which will be in compliance with this code.
- California Fire Code (2016 Edition)
  - Per current fire code, we will install sprinklers in our building and otherwise comply with this code.
- 2016 Building Energy Efficiency Standards for Residential and Non-Residential Building
  - We intend to improve our building with energy efficient features to reduce unnecessary heat and light loss. All improvements will be in compliance with current Title 24 energy efficiency standards.
- Americans with Disabilities Act (ADA) Compliance
  - Our building conversion to a commercial use will include all necessary improvements to be compliant with ADA, including properly sized hallways, door levers, threshold standards, ramp and railing improvements, and unobstructed path of travel to and from our ADA compliant parking lot.
- All codes adopted with local amendments per City of Santa Rosa ordinances



- As new ordinances modify local codes, we will be sure to stay in compliance where applicable.

#### B6. Licensing Maintenance

As state cannabis licensees, we are prepared to submit an annual renewal to remain active. We are also prepared to comply with unscheduled inspections and all state requirements for standard operating procedures (SOP).

#### B7. Substantially Related Offenses Review

None of our business owners have ever committed any substantially related offenses, such as felony convictions, that could hinder approval of our application. We have supplied the City with the required driver's license information in compliance with the LiveScan review process. This information has also been supplied to the state. Any updates will be furnished to both state and local governments in compliance with regulations.

#### B8. Labor Peace Agreement

The State of California requires all cannabis licensees to execute a Labor Peace Agreement with a local union if the licensee employs 20 or more employees. Should any of our respective businesses employ more than 20 individuals, we are prepared to engage a local labor union per requirements. Employees of each company will receive fair wages and, as conditions become appropriate, will be allowed to join a union of their choosing.

#### B9. California Environmental Quality Act

All public agencies in California are required by the California Environmental Quality Act (CEQA) to conduct an environmental assessment of any action they make that has the potential for resulting in a physical change to the environment.



## C. Neighborhood Compatibility

### C1. Use of Premises in Providing Stability, Quality and Support – Compatibility:

As long-time Santa Rosa residents, our business owners recognize and understand the importance of ensuring the compatibility of the business with the surrounding community. We will take all of the steps necessary to meet and exceed the City's expectations for cannabis dispensaries to help contribute to the stability and quality of the surrounding neighborhood.

#### **Parking and transportation**

The property redesign will include a rear parking lot containing 6 parking stalls and a front parking area with 1 ADA accessible space. The City of Santa Rosa parking regulations require one (1) space for every 250 square feet of retail dispensary space. Our proposed building is 1,395 square feet in size including utility areas and requires 6 parking spaces ( $1,395 / 250 = 6$  parking spaces) to be compliant with city code. The City also requires 1 bicycle parking space for every 5,000 square feet of retail space, which our redesigned site will include. This will help to encourage alternative transportation methods by providing customers choosing to bike to the business a place to secure their bicycles outside.

Louie's Gouie's has prepared a draft manual of Standard Operating Procedures which detail the company standards that will be implemented to manage patient and traffic flow to the site. We know that when each person understands their role and duties, workflow and operations run more smoothly and efficiently. While we do not anticipate periods of heavy traffic where our parking area may be at capacity, we propose the following mitigation measures to ensure that traffic does not become an issue with our neighbors:

- **Public transit and ride-share** – Our dispensary will offer discounts to customers and monthly stipends to employees who travel to our dispensary by public transit, carpooling, or ride-share solutions such as taxi, Lyft, or Uber. We are convinced that both customers and employees alike will take advantage of our incentives to save money. In addition to reducing vehicular traffic on and around our property, this solution will also have the added benefit of encouraging more pedestrian traffic along the commercial corridor which will in turn increase safety through more eyes on the street and potential economic benefits to nearby businesses.
- **Security personnel directing traffic** – Louie's Gouie's will employ security personnel to monitor our property during business hours. These individuals will be instructed to:
  1. Prevent crime and loitering;
  2. Ensure the premises stays clean, organized, and free of trash; and
  3. Direct and manage traffic to ensure our parking lot does not end up over capacity and that patrons attempting to enter when the lot is full do not create a parking queue along our vehicle access driveway.
- **Cannabis Retail Delivery** – Our cannabis dispensary business model includes a delivery component to service our patrons who have limited mobility or are too ill to travel to our location. In addition, other customers find delivery a more convenient or discrete way to obtain cannabis products either for medical or recreational uses. Given that one delivery driver can service 10-15 customers per day, with our goal of employing up to 10 drivers, our delivery service will reduce



the number of vehicle trips to our business location by up to 140 trips per day after subtracting our drivers. Less customers driving to our business location provides the following benefits:

1. Reduces vehicle miles on city streets with efficient driver routes which will have a positive effect on air quality;
2. Reduces traffic and the likelihood our neighborhood is significantly impacted during peak hours;
3. Reduces the amount of activity, making it easier for our security personnel to monitor our property and keep it clean;
4. Allows us to scale our business in the future without also scaling potential impacts.

### **Safety and Security**

In compliance with local and state regulation, Louie's Gouies will utilize various safety and security measures outlined in our Security Plan and Fire Suppression and Safety Plan to ensure the protection of our business and deter crime in the neighborhood.

Dispensary patron access to the sales area will be controlled and limited with an electronic access door. Employees will only be allowed to enter the property at specific times. All visitors will be properly screened via walk through or hand-held metal detector and age-verified through an online verification system.

The dispensary will utilize a video surveillance system installed by a licensed third-party security company and monitored both offsite and locally in the security office on the premises. Cameras will be placed inside and outside the building to ensure all areas outlined by the regulatory bodies are under camera coverage. The cameras will be clearly seen during the day and the infrared lights will be clearly seen at night from all outside areas.

The dispensary will also feature an alarm system that is activated at all times the business is closed. The system will detect unauthorized entrance at all entry or exit points, and all exterior windows of the premises. It will also detect movement in the licensed premise when the premise is vacant of employees.

In the event of security breach, local law enforcement will be contacted and dispatched if necessary. The Security Manager will oversee and ensure that the alarm system, video monitoring, and all other security components are in proper working order, and that the system is periodically tested and verified.

### **Nuisance Management**

While cannabis products will be packaged and sealed in tamper-proof packaging when it arrives at the property from a licensed distributor, a small amount of odor is anticipated. Louie's Gouies intends to mitigate for any potential odor through the means described in our Odor Control Plan. The dispensary will utilize industrial-grade odor neutralizers for the interior of the business, and all air from the building will be exhausted through a filtration system that scrubs any cannabis odor ensuring that neighbors and the community will not be able to detect any difference from currently present ambient odors.

The property will include exterior lighting systems for security purposes to provide illumination and clear visibility to all outdoor areas of the premises, including all points of ingress and egress. All exterior lighting will be stationary, fully shielded, directed away from adjacent properties and public rights of way, and of an intensity compatible with the neighborhood. The proposed site redesign will feature trees and plants



that will help shield exterior lighting from adjacent properties. All exterior lighting will be compliant with building codes and with Section 20-30.080 of the City's Outdoor Lighting Ordinance. Interior lighting systems will also be fully shielded, including shades or curtains on all windows to confine light and glare to the interior of the building.

All air conditioning and ventilation equipment will comply with the City's Noise Ordinance (City Code, Chapter 17-16). Trees and plants as well as fencing on the redesigned property will help to reduce noise transmittance from the building to adjacent properties.

The property conforms to the 600-foot minimum setback requirement to a school. In addition, we will ensure that all advertising and marketing efforts are in compliance with City ordinance requirements (keeping all materials 1,000 feet from day care centers, schools, playgrounds, and youth centers) and state regulations restricting advertising to our adult customer audience.

## C2. Odor Control

The City of Santa Rosa is concerned with controlling cannabis odor, which is pungent and can cause a nuisance to neighbors as well as attract unwanted persons. While cannabis products will be packaged and sealed in tamper-proof packaging when it arrives at the property from a licensed distributor, a small amount of odor is anticipated. Louie's Gouie's intends to mitigate for any potential odor through the means described in the attached, Engineer Certified, Odor Control Plan.

## C3. Enhanced Retail Experience

### Site Improvements

From the perspective of the neighborhood, the future location of Louie's Gouies is currently an unoccupied residential structure. The business owners have already taken steps to improve the façade of the structure and have developed a proposed redesign of the site to provide an attractive location for the dispensary. Exterior improvements will benefit the immediate premises and the surrounding area by trimming and updating existing landscaping on the expansive grounds, removing fences, barbed wire and trash, and improving the aesthetics of the area through these efforts. Our use of the existing mature trees to accentuate improved parking areas We wish to create and inviting atmosphere that resonates a sense of safety and welcoming community spirit.

The new proposed look includes improvements to the building's front façade, with added parking areas, ramp access to the building, and enhanced landscaping. We plan to use insulated and security reinforced windows and doors to protect the premises and deter trespassing. To convey the proper level of safety and professionalism, the exterior of our facility will be monitored for litter and debris on a daily basis by our patrolling personnel. Routine landscape services will ensure an attractive building exterior and our plans to participate in and lead neighborhood clean-up efforts will improve the community effect on the whole.

Upon approval, our team will provide a single sign in compliance with city guidelines. We will not advertise or market the business through any signage within 1,000 feet of a day care center, school, playground, or youth center.



All of our business activities will be conducted within the interior of the secured and monitored facility. The dispensary show room, secured storage, and offices will be located behind an interior curtain wall, only accessible to verified visitors and staff. During business operating hours, onsite security personnel will regularly patrol the front entrance and parking lot. After business hours, all doors and windows will auto-lock and will be checked by security prior to leaving the premises.

### **Product Enhancement**

Our owner Luis Chavez has a flair for learning a subject and improving upon the existing template to create enhanced business, products and services. Louie's Gouie's dispensary is no different and the owners have worked hard to ensure that their products are enhanced above and beyond competitors to provide the most effective products to cannabis consumers throughout the community.

#### *Product Storage & Handling Controls*

All products in the Louie's Gouie's inventory for resale and delivery will be stored and handled according to the company's safety and best practices. Products will be stored in designated high-security areas with limited access. Limited-access areas will be restricted to entry by only authorized personnel per company policy (See the Draft SOP Manual, Attached).

Manual and digital tracking systems allow constant monitoring of inventory including an exact count and listing of available products in real-time. Inventory will be routinely audited bi-weekly per our company's standard procedure and may be audited at additional intervals per the discretion of management staff. Our policies and procedures include standards for entry of all inventory into the state's Track-And-Trace system. Through various inventory and tracking procedures, we can know the location of every product whether in transit to a delivery or retained on the premises.

#### *Child Resistant Packaging*

In compliance with state law and our commitment to social responsibility, we will ensure that every package containing cannabis that is delivered by our company, will be either placed in a Child Resistant (CR) outer package such as an opaque, sealed bag and/or sealed in a Child Resistant container. Inventory products for resale and delivery will be purchased from only licensed distributors that have certified their products as CR.

In addition to the specifications above, Child Resistant packaging used by our service will adhere to the following requirements:

- The package will protect the product from contamination and will not expose the product to any toxic or harmful substance;
- The package will be tamper-evident, which means that the product will be contained in packaging that is sealed so that the contents cannot be opened without obvious destruction of the seal;
- The package will be child-resistant, which means it will be designed or constructed to be significantly difficult for children under five years of age to open or otherwise obtain access to the contents within a reasonable time but will not be difficult for normal adults to open or access the products inside. A package will be considered child-resistant if it satisfies the standard for "special





packaging” as set forth in the Poison Prevention Packaging Act of 1970 Regulations (16 C.F.R. §1700.a(b)(4))

- Packages containing multiple servings will be resealable to maintain CR throughout the life of the package.

#### *Not Attractive to Children*

The safety of children who may be exposed in some way to cannabis product packaging is paramount to our company and the community at large. State and local regulations assist us in this effort by providing guidelines for company policies. It is our policy that no container will imitate any packaging or labeling used for products typically marketed to children, such as brightly-colored candy.

#### *Properly Labeled*

Packaging and labeling standards have been prepared to comply with requirements specified by the Bureau of Cannabis Control, Section 5412, and California Business and Professions Code section 26120 to ensure our company’s consistent compliance across both A and M license regulations. Standards are reviewed regularly to stay current with the changing and growing industry.

Examples of specific labeling requirements that may be highlighted here are as follows:

- The label will include an information panel containing – The name and contact information of the licensed manufacturer and the date of manufacture;
- For packages delivered under “M” licensure, the following warning will be included along with potency, strain and testing information:

“GOVERNMENT WARNING: “THIS PRODUCT CONTAINS CANNABIS, A SCHEDULE I CONTROLLED SUBSTANCE. KEEP OUT OF REACH OF CHILDREN AND ANIMALS. CANNABIS PRODUCTS MAY ONLY BE POSSESSED OR CONSUMED BY PERSONS 21 YEARS OF AGE OR OLDER UNLESS THE PERSON IS A QUALIFIED PATIENT. THE INTOXICATING EFFECTS OF CANNABIS PRODUCTS MAY BE DELAYED UP TO TWO HOURS. CANNABIS USE WHILE PREGNANT OR BREASTFEEDING MAY BE HARMFUL. CONSUMPTION OF CANNABIS PRODUCTS IMPAIRS YOUR ABILITY TO DRIVE AND OPERATE MACHINERY. PLEASE USE EXTREME CAUTION.”

## D. Clear and Attractive Entrance, Pedestrian Orientation, Bike Parking & Access to Transit

### **Proposed Property Improvements**

Our proposal is to completely rehabilitate the property, which would include the following improvements (Please refer to architectural plans for improvement specifications):

- Exterior Improvements
  - Installation of attractive landscaping in the front and rear yards, particularly along the street
  - Removal of all dilapidated fencing
  - Removal of all wood sheds in the back yard
  - Installation of a 6-space rear parking lot and an ADA parking space in the front yard

- Installation of security lights in the front and rear of the property in compliance with the City's lighting ordinance
- Installation of walkways in the front and rear yards
- ADA accessible ramp improvements with a railing at the front entrance
- Upgraded windows (inserts) for the entire existing building
- Exterior painting and trim
- Interior Improvements
  - Relocation of interior walls
  - Installation of laminate flooring
  - Installation of granite countertops
  - Interior painting and trim
  - ADA improvements to both bathrooms
  - Installation of restricted access security doors
  - Installation of security and surveillance equipment
  - Installation of retail showroom cabinets
  - Installation of security window in lobby

The goal of our improvements will be twofold. First we want to demonstrate to our neighbors how a legal retail dispensary should look and operate. Once we are in operation, they will begin to understand that our retail establishment is no different than the adjacent retail complex that includes Subway, Starbucks, and several other businesses. Additionally, they will be impressed by how our property improvements, maintenance, security personnel, surveillance, and adherence to good standard operating procedures actually improves the area far beyond a typical retail store. In fact, recent studies from Colorado and other parts of California have determined that in contrast to previous beliefs, properly run cannabis dispensaries actually increase property values, safety, and significantly increase profitability of nearby businesses as our patrons are more likely to make other purchases while in the area. Additionally, they will see that inclusion of our delivery service helps greatly to moderate vehicular traffic activity and our incentive program for mass transit and shared ride users increases pedestrians on the streets.

#### *Exterior*

Second, we want to create an excellent user experience for our customers starting with maintaining a clean exterior parking lot and entryway. Our front entry is approximately 40 feet from the existing road. Our walkways, ADA accessible ramp, and entryways will all be improved to current commercial building code, including the addition of a railing to the front entry ramp. As per our architectural plans, the railings, tread, slope, door handles, and thresholds will be compliant with California and City building codes, as well as ADA standards. Per our lighting plan, all parking areas and building entries will be illuminated with City code compliant lighting that improves security and visibility on the property while shielding light pollution that may otherwise cause a nuisance. We have already started the process of replacing the existing windows with new and attractive double-pane windows. We plan to repaint the entire exterior including trim, which will provide our building with a much-needed face lift. All entry doors will be replaced with high-quality security doors that prevent any potential robberies but are also attractive.

#### *Parking Analysis*

The property redesign will include a rear parking lot containing 6 parking stalls and a front parking area with 1 ADA accessible space. The City of Santa Rosa parking regulations require one (1) space for every 250 square feet of retail dispensary space. Our proposed building is 1,395 square feet in size including



utility areas and requires 6 parking spaces ( $1,395 / 250 = 6$  parking spaces) to be compliant with city code. The City also requires 1 bicycle parking space for every 5,000 square feet of retail space, which our redesigned site will include. This will help to encourage alternative transportation methods by providing customers choosing to bike to the business a place to secure their bicycles outside.

#### *Storefront, Signage and Window Treatments*

Our property will only include one discreet sign advertising our business at this location. Before any signage is installed, we will comply with the City's sign ordinance by applying for a permit with drawings and/or specifications. We intend to only advertise the name of our business with no product information or any marketing slogans indicating that we are a dispensary.

We have already replaced several windows on the building, which did not require a permit, as they were inserted without any modifications to the building. We will continue to replace any remaining windows as the new windows are more attractive, dual pane, and higher quality, meaning greater energy efficiency within.

#### *Interior*

Moving into the building, we propose to improve the interior with a designated front lobby that is in compliance with state regulations. This front reception area will be where we check in and verify visitors and also where our queue for showroom entry will wait. We will improve this room with attractive laminate flooring, painting, waiting room furniture, and a security window for our staff to safely verify visitors. Once verified, our guests will be buzzed into our showroom, which will be similar in appearance to the photo below. This attractive showroom will provide a comfortable environment for our customers to preview our products, obtain education from our skilled budtenders, and complete their orders.



We have set aside a designated room for receiving vendors adjacent to our secured storage room, allowing our employees to discretely purchase and store products out of sight of any visitors. This room also provides added security, as vendors will first be verified and then unable to access our restricted access storage room without additional entry approval. We will install a panic button and surveillance cameras in this room as well as our lobby and show room to further prevent any unlikely robberies should they happen to circumvent our onsite security personnel and verification protocols. The remainder of our building will be improved with upgraded commercial ADA compliant bathrooms, offices for dispatchers and management, and a breakroom in the back.

*Pedestrian Orientation and Access to Transit*

One of several key features of the 316 Yolanda Avenue property is its proximity to downtown Santa Rosa and the local bus system. The closest bus stop is located at the northeast corner of Yolanda Avenue and Santa Rosa Avenue less than 200 feet from our proposed dispensary. There are also bus stops approximately 0.2 and 0.5 miles away from the property that are served by multiple bus lines. The proximity of these bus stops will provide a way for customers and employees of our facility living downtown to travel to the business using public transit. As discussed, we will make special discounts available to those who use Santa Rosa’s public transportation as a way to increase the City’s safety and lessen the traffic and parking burden on our property. In consideration of those whose conditions render them unsafe to drive, our educational and outreach programs will encourage use of the City’s public transit as a means of procuring their needed medication.



The pedestrian entrance to the business faces Yolanda Avenue, making it easy to monitor foot traffic to the site. Signage will identify the business name and information, indicating where pedestrians can enter the building.



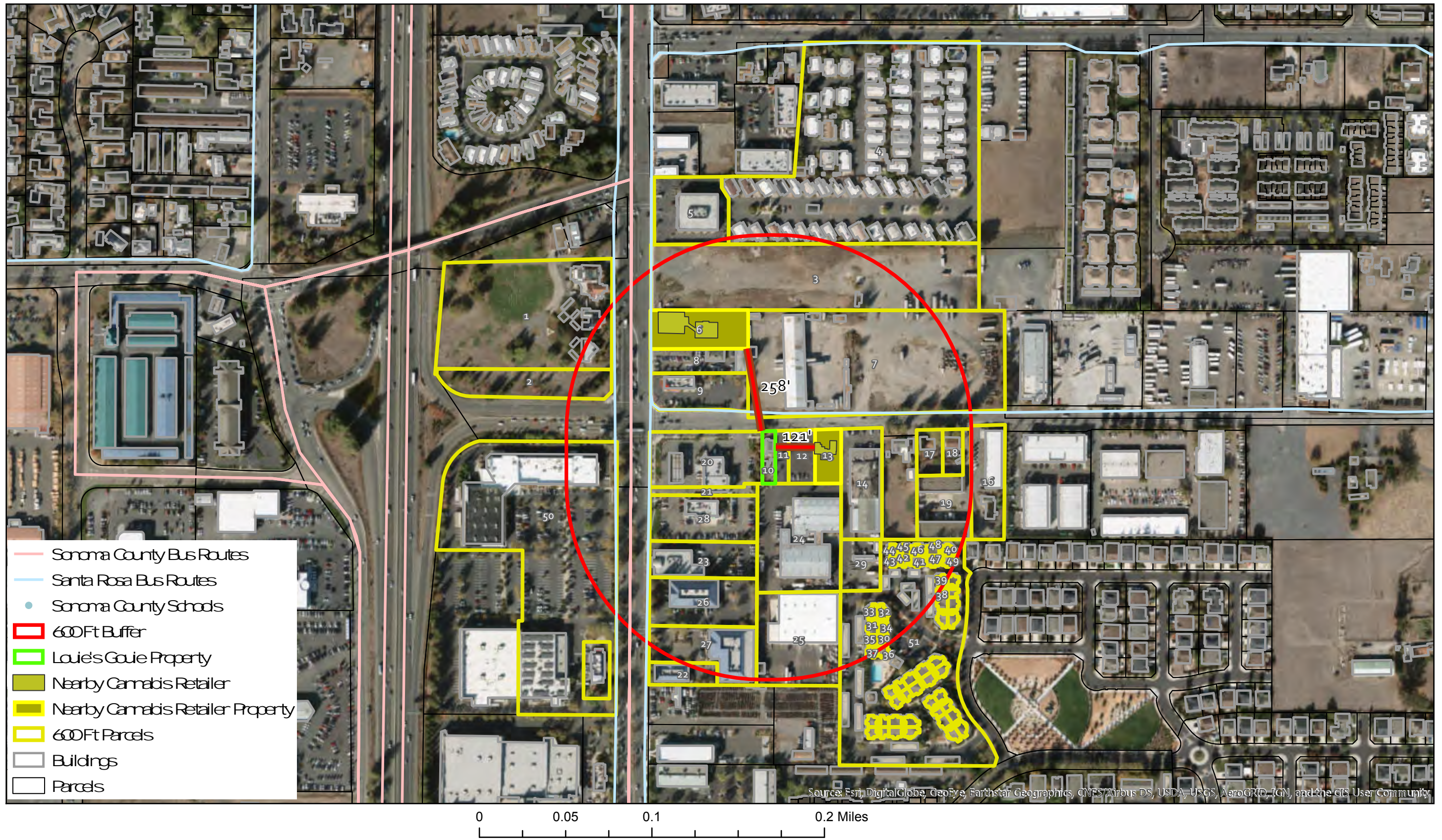

- Sonoma County Bus Routes
- Santa Rosa Bus Routes
- Sonoma County Schools
- 600Ft Buffer
- Louie's Cove Property
- Nearby Camabis Retailer
- Nearby Camabis Retailer Property
- Buildings
- Parcels



# Neighborhood Context Map



APN 044-072-005  
316 Ydamba Avenue, Santa Rosa

Note: Properties within 600 feet are numbered and correspond to the attached table

Date: 6-18-18



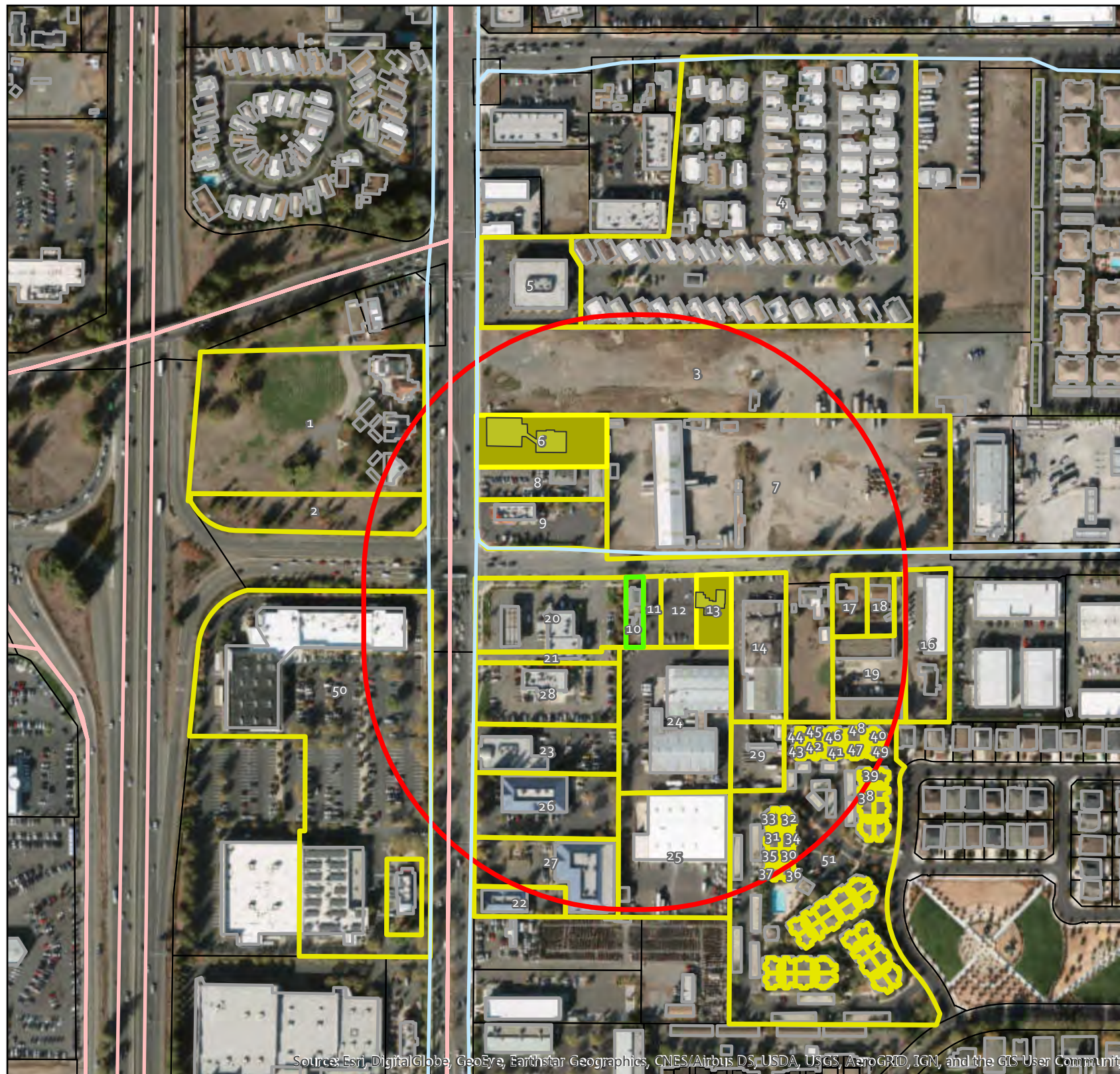

Source: Esri, DigitalGlobe, GeoEye, Earthstar Geographics, CNES/Airbus DS, USDA, USGS, AeroGRID, IGN, and the GIS User Community



ID APN	Owner	S Street Address	UseCodType
50 043-102019		8905 TOWNE CENTRE DR # 108, SANTA ROSA, CA 95452	Commercial
1 043-102025	SENTINEL CREMATION SOCIETIES INC	2607 SANTA ROSA AVE, SANTA ROSA, CA 95404	Commercial
2 043-102026	SE COMBINED SERVICES OF CALIFORNIA INC	SANTA ROSA AVE, SANTA ROSA, CA 95405	Residential
3 044-041-010	HULLSMAN TRANSPORTATION CO	2532 SANTA ROSA AVE, SANTA ROSA, CA 95406	Commercial
4 044-041-090	CARRIAGE COURT MHP LLC	250 KAVANA SPRINGS RD, SANTA ROSA, CA 95407	Commercial
5 044-041-101	VEALE HENRY KIRK	2510 SANTA ROSA AVE, SANTA ROSA, CA 95408	Commercial
6 044-071-001	NATOLI GROUP 1 LLC	2612 SANTA ROSA AVE, SANTA ROSA, CA 95409	Commercial
7 044-071-002	HULLSMAN PAUL JOSEPH ET AL	325 YOLANDA AVE, SANTA ROSA, CA 95410	Commercial
8 044-071-004	NATOLI GROUP 1 LLC	2620 SANTA ROSA AVE, SANTA ROSA, CA 95411	Commercial
9 044-071-007	ARCHLAND PROPERTY II LP ET AL	2642 SANTA ROSA AVE, SANTA ROSA, CA 95412	Commercial
10 044-072-005	BARRETTA RICK SHERWIN ET AL	316 YOLANDA AVE, SANTA ROSA, CA 95413	Residential
11 044-072-006	HENDERSON ALLANA & KIMBERLY L TR	324 YOLANDA AVE, SANTA ROSA, CA 95414	Commercial
12 044-072-007	HENDERSON ALLANA & KIMBERLY L TR	330 YOLANDA AVE, SANTA ROSA, CA 95415	Commercial
13 044-072-008	HENDERSON ALLANA & KIMBERLY L TR	350 YOLANDA AVE, SANTA ROSA, CA 95416	Commercial
14 044-072-009	HENDERSON ALLANA & KIMBERLY L TR	368 YOLANDA AVE, SANTA ROSA, CA 95417	Commercial
16 044-072-012	MAHANGINA TRET AL	414 YOLANDA AVE, SANTA ROSA, CA 95418	Commercial
17 044-072-019	DREVERIC WTR & DREW MARY A TR	376 YOLANDA AVE, SANTA ROSA, CA 95419	Residential
18 044-072-021	DREVERIC WTR & DREW MARY A TR	380 YOLANDA AVE, SANTA ROSA, CA 95420	Residential
19 044-072-022	DREVERIC WTR & DREW MARY A TR	394 YOLANDA AVE A, SANTA ROSA, CA 95421	Commercial
20 044-072-023	C & H DEVELOPMENT CO	2648 SANTA ROSA AVE, SANTA ROSA, CA 95422	Commercial
21 044-072-024	C & H DEVELOPMENT CO	SANTA ROSA AVE, SANTA ROSA, CA 95423	Commercial
22 044-081-005	FOULSEN HELGA F TR	2724 SANTA ROSA AVE, SANTA ROSA, CA 95424	Commercial
23 044-081-022	FROBST TONY C & INGRID R TR	2700 SANTA ROSA AVE, SANTA ROSA, CA 95425	Commercial
24 044-081-024	HENDERSON ALLANA & KIMBERLY L TR	NONE, SANTA ROSA, CA 95426	Commercial
25 044-081-029	HENDERSON ALLANA & KIMBERLY L TR	324 YOLANDA AVE, SANTA ROSA, CA 95427	Commercial
26 044-081-034	PARROTT JANICE CTRET AL	2716 SANTA ROSA AVE, SANTA ROSA, CA 95428	Commercial
27 044-081-035	CP&A SANTA ROSA LLC	2720 SANTA ROSA AVE, SANTA ROSA, CA 95429	Commercial
28 044-081-036	SANGUINETTI NORMAN H TR & SANGUINETTI GLADYS D TR	2688 SANTA ROSA AVE, SANTA ROSA, CA 95430	Commercial
29 044-390-061	HENDERSON ALLANA & KIMBERLY L TR	NONE, SANTA ROSA, CA 95431	Commercial
30 044-480-055	DCMFI 16 HARVEST PARK LLC	2335 SUMMERCREEK DR 55, SANTA ROSA, CA 95432	Residential
31 044-480-058	DCMFI 16 HARVEST PARK LLC	2335 SUMMERCREEK DR 58, SANTA ROSA, CA 95433	Residential
32 044-480-059	DCMFI 16 HARVEST PARK LLC	2335 SUMMERCREEK DR 59, SANTA ROSA, CA 95434	Residential
33 044-480-060	DCMFI 16 HARVEST PARK LLC	2335 SUMMERCREEK DR 60, SANTA ROSA, CA 95435	Residential
34 044-480-063	DCMFI 16 HARVEST PARK LLC	2335 SUMMERCREEK DR 63, SANTA ROSA, CA 95436	Residential
35 044-480-066	DCMFI 16 HARVEST PARK LLC	2335 SUMMERCREEK DR 66, SANTA ROSA, CA 95437	Residential
36 044-480-067	DCMFI 16 HARVEST PARK LLC	2335 SUMMERCREEK DR 67, SANTA ROSA, CA 95438	Residential
37 044-480-068	DCMFI 16 HARVEST PARK LLC	2335 SUMMERCREEK DR 68, SANTA ROSA, CA 95439	Residential
38 044-480-074	DCMFI 16 HARVEST PARK LLC	2343 SUMMERCREEK DR 74, SANTA ROSA, CA 95440	Residential
39 044-480-078	DCMFI 16 HARVEST PARK LLC	2343 SUMMERCREEK DR 78, SANTA ROSA, CA 95441	Residential
40 044-480-086	DCMFI 16 HARVEST PARK LLC	2347 SUMMERCREEK DR 86, SANTA ROSA, CA 95442	Residential
41 044-480-089	DCMFI 16 HARVEST PARK LLC	2347 SUMMERCREEK DR 89, SANTA ROSA, CA 95443	Residential
42 044-480-091	DCMFI 16 HARVEST PARK LLC	2347 SUMMERCREEK DR 91, SANTA ROSA, CA 95444	Residential
43 044-480-093	DCMFI 16 HARVEST PARK LLC	2347 SUMMERCREEK DR 93, SANTA ROSA, CA 95445	Residential
44 044-480-096	DCMFI 16 HARVEST PARK LLC	2347 SUMMERCREEK DR 96, SANTA ROSA, CA 95446	Residential
45 044-480-098	DCMFI 16 HARVEST PARK LLC	2347 SUMMERCREEK DR 98, SANTA ROSA, CA 95447	Residential
46 044-480-100	DCMFI 16 HARVEST PARK LLC	2347 SUMMERCREEK DR 100, SANTA ROSA, CA 95448	Residential
47 044-480-101	DCMFI 16 HARVEST PARK LLC	2347 SUMMERCREEK DR 101, SANTA ROSA, CA 95449	Residential
48 044-480-102	DCMFI 16 HARVEST PARK LLC	2347 SUMMERCREEK DR 102, SANTA ROSA, CA 95450	Residential
49 044-480-103	DCMFI 16 HARVEST PARK LLC	2347 SUMMERCREEK DR 103, SANTA ROSA, CA 95451	Residential
51 044-480-000	DCMFI 16 HARVEST PARK LLC	2347 SUMMERCREEK DR, SANTA ROSA, CA 95453	Residential

# Neighborhood Context Map-Table

APN 044-072-005  
316 Ydanda Avenue, Santa Rosa

Note: Properties within 600 feet are numbered and correspond to the attached table



Date: 6-18-18



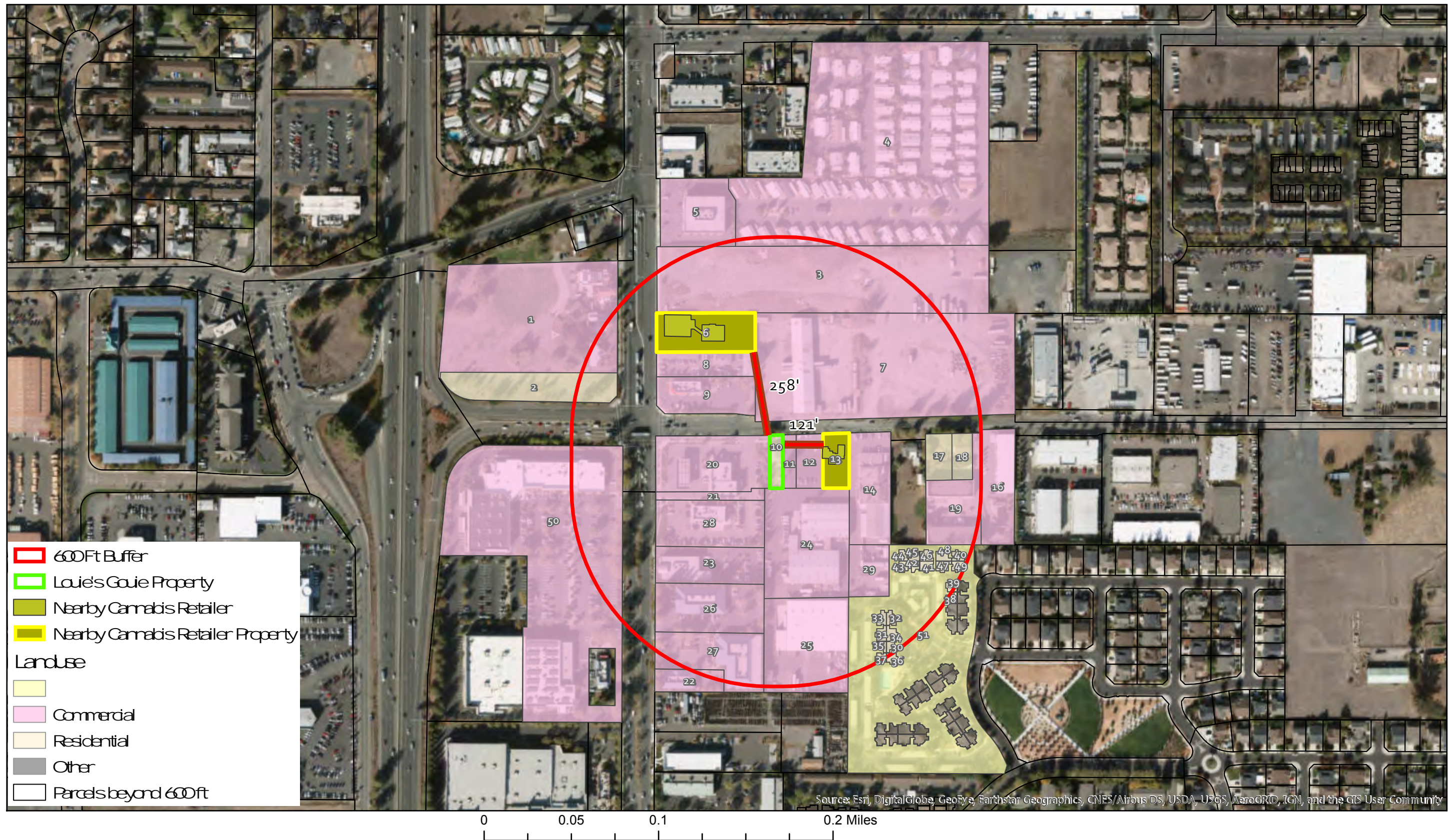

# Neighborhood Context Map-Landuse



APN 044-072-005  
 316 Ydamba Avenue, Santa Rosa

Note: Properties within 600 feet are numbered and correspond to the attached table

Date: 6-18-18





## D. Neighborhood Enhancement

### D1. Quality and Extent of Improvements to the Site, Building & Surrounding Neighborhoods

We propose to locate our storefront retail dispensary at 316 Yolanda Avenue. This location is completely surrounded by commercial and industrial land uses surround the property, most of which are poorly maintained to severely decrepit. As can be seen on our attached Neighborhood Photo Plate, Property Photo Plate, and Neighborhood Context/Land Use Maps, our location is arguably the worst property on the street and badly in need of repair. The only nearby property in good condition is the retail complex at the corner of Yolanda and Santa Rosa Avenues.

Our context maps demonstrate that our proposed dispensary is more than 600 feet away from any sensitive use, as defined by state law and City code, including schools, daycare centers, or youth centers. In addition, the only residential properties within 600 feet are located on the other side of our southern neighbor and not within view of our property.

We have included land use and zoning information on the attached context maps indicating that our property is zoned commercial. Although the property contains a house and has been used for residential uses, we propose to change the use to commercial retail. This change is consistent with the City of Santa Rosa General Plan, as it coincides with the current City zoning map. In addition, our proposed retail use is very compatible with surrounding uses that include retail and industrial. Both our context maps and architectural plans demonstrate that our storefront entrance is in a visible location that provides an unobstructed view from the public right-of-way.

We have identified on our context map two nearby properties that are also proposing cannabis storefront retail. The closest proposed retail property is immediately adjacent to our own, as shown in the photo below at 330 Yolanda Avenue. The use proposed for this location is a microbusiness, which would reconstruct the current auto dealership in the front and renovate the rear buildings for cultivation, manufacturing, and distribution. The second proposed dispensary would also be a part of a microbusiness and located at 2612 Santa Rosa Avenue. Both properties are much larger than our own, meaning a dispensary at either location would also be larger and have a more significant impact on the neighborhood. We feel that our dispensary location offers more significant benefits to the city, for the following reasons:

- Our property is more likely to connect to the pedestrian-friendly sidewalk and landscaping already developed on the adjacent retail complex;
- Our property will be more likely to take advantage of the City and County bus routes on Santa Rosa Avenue with pedestrian-friendly improvements;
- Our property is more dilapidated than any other building in the area, meaning our rehabilitation and secure, customer-friendly operation will make a more dramatic improvement; and
- Our smaller “mom and pop” storefront and added delivery service will reduce vehicular traffic in the area compared to a megastore at either of the other two locations.

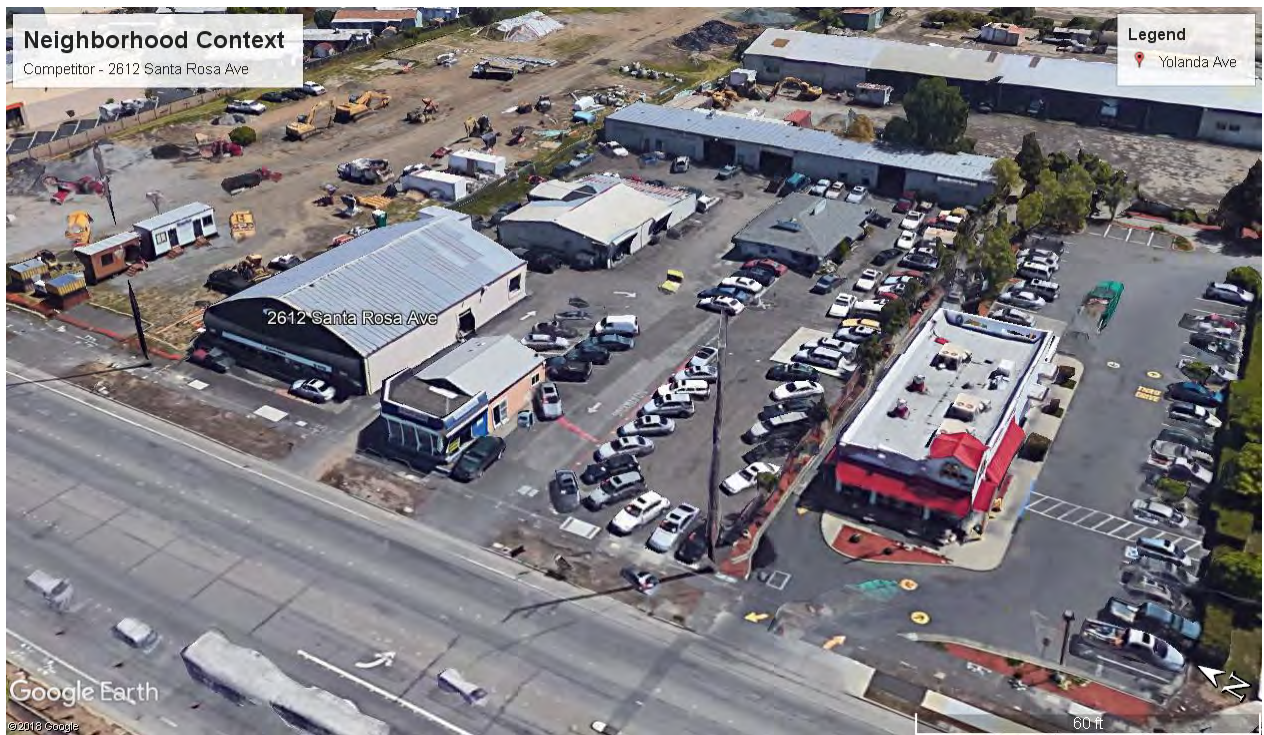





## D2. Integration through Attractive Façade, Setbacks, Quality Materials and Colors, Landscaping, Safe Circulation and Location of Driveways, and Ease of Parking

As indicated previously, our property is the most dilapidated on Yolanda Avenue, with the possible exception of the industrial property across the street (see neighborhood photo plate). The property was previously used as a residence and still contains the various walls, bedrooms, kitchens, and baths. The previous tenant operated an illegal cultivation operation that utilized the entire house, as well as several degraded sheds in the back yard that are now considered a nuisance by our neighbors. As a result of this illegal activity and along with compounded poor maintenance, the property is now in very poor shape. In addition, the front yard has and continues to be used as a parking lot, with no landscaping, and severely compacted soils.

The back yard is also poorly maintained with overgrown vegetation, mismatched fencing, and inclusion of barbed wire along the top of the fence. Finally, the adjacent retail property to the west is currently used by the local homeless population as a camp along the entire length of our fence, as it affords shade and some seclusion. These individuals are not only causing an eye-sore but also regularly leave trash and debris along the fence and the front of our property.

### **Proposed Property Improvements**

Our proposal is to completely rehabilitate the property, which would include the following improvements (Please refer to architectural plans for improvement specifications):

- Exterior Improvements
  - Installation of attractive landscaping in the front and rear yards, particularly along the street
  - Removal of all dilapidated fencing
  - Removal of all wood sheds in the back yard
  - Installation of a 6-space rear parking lot and an ADA parking space in the front yard
  - Installation of security lights in the front and rear of the property in compliance with the City's lighting ordinance
  - Installation of walkways in the front and rear yards
  - ADA accessible ramp improvements with a railing at the front entrance
  - Upgraded windows (inserts) for the entire existing building
  - Exterior painting and trim
- Interior Improvements
  - Relocation of interior walls
  - Installation of laminate flooring
  - Installation of granite countertops
  - Interior painting and trim
  - ADA improvements to both bathrooms
  - Installation of restricted access security doors
  - Installation of security and surveillance equipment
  - Installation of retail showroom cabinets
  - Installation of security window in lobby

The goal of our improvements will be twofold. First, we want to demonstrate to our neighbors how a legal retail dispensary should look and operate. Once we are in operation, they will begin to understand that our retail establishment is no different than the adjacent retail complex that includes Subway, Starbucks, and several other businesses. Additionally, they will be impressed by how our property improvements,



maintenance, security personnel, surveillance, and adherence to good standard operating procedures actually improves the area far beyond a typical retail store. In fact, recent studies from Colorado and other parts of California have determined that in contrast to previous beliefs, properly run cannabis dispensaries actually increase property values, safety, and significantly increase profitability of nearby businesses as our patrons are more likely to make other purchases while in the area. Additionally, they will see that inclusion of our delivery service helps greatly to moderate vehicular traffic activity and our incentive program for mass transit and shared ride users increases pedestrians on the streets.

### *Exterior*

Second, we want to create an excellent user experience for our customers starting with maintaining a clean exterior parking lot and entryway. Our front entry is approximately 40 feet from the existing road. Our walkways, ADA accessible ramp, and entryways will all be improved to current commercial building code, including the addition of a railing to the front entry ramp. As per our architectural plans, the railings, tread, slope, door handles, and thresholds will be compliant with California and City building codes, as well as ADA standards. Per our lighting plan, all parking areas and building entries will be illuminated with City code compliant lighting that improves security and visibility on the property while shielding light pollution that may otherwise cause a nuisance. We have already started the process of replacing the existing windows with new and attractive double-pane windows. We plan to repaint the entire exterior including trim, which will provide our building with a much-needed face lift. All entry doors will be replaced with high-quality security doors that prevent any potential robberies but are also attractive.

### *Parking Analysis*

The property redesign will include a rear parking lot containing 6 parking stalls and a front parking area with 1 ADA accessible space. The City of Santa Rosa parking regulations require one (1) space for every 250 square feet of retail dispensary space. Our proposed building is 1,395 square feet in size including utility areas and requires 6 parking spaces ( $1,395 / 250 = 6$  parking spaces) to be compliant with city code. The City also requires 1 bicycle parking space for every 5,000 square feet of retail space, which our redesigned site will include. This will help to encourage alternative transportation methods by providing customers choosing to bike to the business a place to secure their bicycles outside.

### *Storefront, Signage and Window Treatments*

Our property will only include one discreet sign advertising our business at this location. Before any signage is installed, we will comply with the City's sign ordinance by applying for a permit with drawings and/or specifications. We intend to only advertise the name of our business with no product information or any marketing slogans indicating that we are a dispensary.

We have already replaced several windows on the building, which did not require a permit, as they were inserted without any modifications to the building. We will continue to replace any remaining windows as the new windows are more attractive, dual pane, and higher quality, meaning greater energy efficiency within.

### *Interior*

Moving into the building, we propose to improve the interior with a designated front lobby that is in compliance with state regulations. This front reception area will be where we check in and verify visitors and also where our queue for showroom entry will wait. We will improve this room with attractive



laminated flooring, painting, waiting room furniture, and a security window for our staff to safely verify visitors. Once verified, our guests will be buzzed into our showroom, which will be similar in appearance to the photo below. This attractive showroom will provide a comfortable environment for our customers to preview our products, obtain education from our skilled budtenders, and complete their orders.



We have set aside a designated room for receiving vendors adjacent to our secured storage room, allowing our employees to discretely purchase and store products out of sight of any visitors. This room also provides added security, as vendors will first be verified and then unable to access our restricted access storage room without additional entry approval. We will install a panic button and surveillance cameras in this room as well as our lobby and show room to further prevent any unlikely robberies should they happen to circumvent our onsite security personnel and verification protocols. The remainder of our building will be improved with upgraded commercial ADA compliant bathrooms, offices for dispatchers and management, and a breakroom in the back.

#### *Secured Storage*

We have designated a secured storage room on our plans where we intend to store our valuable products. This room will be designed and constructed to prevent any type of forced entry. Additionally, we intend to reinforce the exterior wall with materials such as sheet metal and additional wood members to prevent the possibility of breaking through. The room will also be equipped with a motion sensor, surveillance camera, and panic button as part of our security system, explained further in our security plan.

#### *Security Doors and Windows*



We intend to install security doors at all exterior entries and those interior openings identified in the security plan. Our doors will either be the same, or similar to the door systems described on the attached security door specifications by GSS Doors. In summary, these doors are designed to help create a secure environment for locations with extremely high threat profiles or security challenges. This door was tested at NTS Chesapeake in Belcamp, MD to the U.S. State Department (DoS) forced entry standards and are bullet and forced entry resistant.

We also plan to install a security window similar to the attached product catalog for the CRL Bullet Resistant Windows. This window is designed to allow our staff to interact with visitors safely while checking credentials. Once verified, the visitor will be buzzed into our restricted access show room. If instead the person cannot be verified, they will not be allowed entry.

### D3. Environmental Benefits – Green Business Practices Related to Energy and/or Water Conservation

#### **Environmental Benefits**

Our dispensary is committed to green building and operating practices to reduce impacts on landfills, air quality, traffic, and energy consumption. First, our decision to locate our business at 316 Yolanda Avenue will benefit the city and environment by rehabilitating the previously dilapidated property and structure and improving the quality of the neighborhood. The current facility will require many improvements to both the interior and exterior prior to opening its doors for interaction with the public. We view these necessary improvements as an opportunity to contribute to “Green” business practices in the local community.

Second, our remodeling efforts have and will include reuse of as much of the existing materials as possible while also ensuring compliance to local and state regulations. Improvements to our building will also include state-of-the art climate control and automated technology solutions based on current Title 24 building standards to reduce heating/cooling energy costs, as well as installation of LED and energy efficient lighting in overhead lamps and fixtures to reduce our carbon footprint.

Third, our parking reduction incentive program will reduce the number of vehicles travelling to our dispensary, as well as associated air pollution. Our goal is to reduce air quality impacts compared with existing baselines established by the Air Resources Board for our type of retail land use entitlement by increasing the use of mass transit and ride shares, as well as to prevent air leakage from our building as much as possible.

Fourth, as a retail business, our operation will not include the use of water other than for bathroom and breakroom purposes. Similarly, we do not intend to produce a significant amount of trash and recyclables but will institute a program as noted in our waste management plan for reusing and recycling packaging received from vendors as much as possible.

### D4. Community Benefits – Employment Opportunities, Community Programs and Contributions

#### **Community Benefits**



Our team recognizes that the success of legal cannabis ultimately rests in its economic and social impact on communities across the state and country. That is why we are grateful for the opportunity to discuss the effects our business is most likely to have on the community from both the perspective of our past non-cannabis business experiences, our recent cannabis-related activities under Proposition 215 regulations, and our ongoing community involvement efforts with the democratic party, contributions to mental illness organizations, and other social organizations. We welcome dialogue from the City of Santa Rosa that will allow us to further discuss our commitment to the hometown where our owner has made his entire career.

### *Employment Opportunities*

Our team's employment projections are based on the conditions of the marketplace in its present state. As we succeed here in Santa Rosa, we are confident that other cities in the area will follow suit. Should other nearby localities begin to permit delivery of cannabis, our customer base could be impacted substantially. With the exception of this consideration, we expect to employ a total of up to three budtenders and one cashier per shift with two shifts occurring per day. We also anticipate maintaining three additional staff members to manage inventory, support employees on the floor, and dispatch delivery drivers. Additionally, our delivery service will employ up to five drivers per shift. Our company security plan requires a minimum of one security personnel on the premises throughout the workday and a patrol of the property during passive, non-working hours.

We anticipate the creation of approximately 29 new jobs over the next three years, with a minimum of 10 new employees upon completion of our licensing process in 2018. All of our recruiting efforts will be directed at local applicants who:

1. Reside within the county or surrounding areas;
2. Have interest in and knowledge of the cannabis industry;
3. Have successfully completed the required criminal background check; and
4. Who wish to learn more about growth within the industry.

We plan to give special preference to active military members and veterans who can benefit from employment opportunities in many ways. In addition to permanently retained employees, our facility will initially require the services of outside experts in marketing, IT, packaging and janitorial services, providing additional employment opportunities for the greater Santa Rosa community. In time, these services will become jobs created in-house, providing even more opportunities to locals.

Our team values the expertise and dedication to training that employees bring to their daily work. As has been our practice, we have included positions that can be filled through a program of upward mobility, providing valuable training and career opportunities that sustain employees and their families. Our equal employment opportunities will include in-house training that enhances employees' careers in many areas, even if they choose to pursue other types of employment in the future. In addition to cannabis-based training, onsite trainings and workshops will educate employees in areas like safety, hazard prevention, protective equipment, customer service, emergency response and harassment prevention as well as paid engagement seminars and conferences for management and marketing training. Once we are fully built



out, we expect to contribute well over one million in annual wages and benefits to the Santa Rosa economy from our location.

*Community Programs and Contributions*

Married for over 25 years, Luis and Delia Chavez have started, run and sold over 20 businesses, including three regulated and licensed operations. They have created jobs, exceeded customer expectations, and been very, very active members of their Santa Rosa community. Luis is loved by many for the big heart and spirit he contributes to the Santa Rosa needy children at Christmas or our homeless when they are hungry and scared.

Integrating legal cannabis into the community requires care and tact along with a dedicated effort. Our business owner, Luis Chavez, will serve as the primary Community Relations Liaison for Louie's Gouies.



## E. Waste Management & Recycling Plan

### E1. Cannabis Waste and Green Practices

We will contract with a licensed and professional cannabis waste management firm to properly and legally dispose of any cannabis our operation generates from product displays, returns or other activities that render cannabis not saleable. We expect our exposure in this regard to be limited as we have and will continue to develop relationships with our licensed distribution suppliers to ensure that they are not only compliant with their responsibilities but acting in the best interest of their business partners and the entire consumer community. Our products are intended to be effective and recommended with a high level of therapeutic accuracy to mitigate returns and waste.

As a retailer who is limited to the local supply of licensed distributors, our control over green exit packaging will be limited to market availability. As such, we plan to reward those manufacturers who utilize green over non-green packaging. We will also use green exit packaging wherever possible and encourage recycling of the materials we sell. All of the cardboard waste produced by our operation will be recycled through available means. Litter and debris will be monitored by regularly scheduled landscaping and daily by security and dispensary personnel.

### E2. Other Business Waste and Recycling

Our use of local services such as water and trash are expected to be no greater than any other business in the area. As a dispensary, our water consumption will be restricted to what one would expect from a typical busy retail operation, with the vast majority of the usage from the bath and break rooms.

Our business is committed to local recycling programs and will encourage staff through our standard operating procedures and employee training to separate recyclables and yard debris from our waste stream.



# Louie's Gouie's

## Manual of Standard Operating Policies

*Prepared in Conformance With the*  
California Code of Regulations, Title 16  
Division 42, Bureau of Cannabis Control  
Chapter 3, Retailers





# Table of Contents

---

- I. Retailers - General Provisions**
  - a. 5400 Access to retailer premises
  - a. 5401 Limited access areas
  - b. 5402 Retail area
  - c. 5403 Hours of operation
  - d. 5404 Retail customers
  - e. 5405 Cannabis goods display
  - f. 5406 Cannabis goods for sale
  - g. 5407 Sale of non-cannabis products on premises
  - h. 5408 Live plants
  - i. 5409 Daily limits
  - j. 5410 Customer return of cannabis goods
  - k. 5411 Free cannabis goods
  - l. 5412 Packaging and labeling
  - m. 5413 Exit packaging
  - n. 5414 Type 9-Non Storefront Retailer
  - o. 5415 Delivery
  - p. 5416 Delivery to a physical address
  - q. 5417 Methods of delivery
  - r. 5418 Cannabis goods carried during delivery
  - s. 5419 Cannabis consumption during delivery
  - t. 5420 Delivery request receipt
  - u. 5421 Delivery route
  - v. 5422 Receiving shipments of inventory
  - w. 5423 Inventory documentation
  - x. 5424 Inventory reconciliation
  - y. 5425 Record of sales
  - z. 5426 Records

## **5400. Access to Retailer Premises**

The following section outlines the regulations on access to the premises

- 1 SOPs will be developed to ensure that access to the licensed premises of an A-retailer licensee will be limited to individuals who are at least 21 years of age and have a genuine business reason for entering the premises**
  
- 2 In addition to Step #1 above, standards will be developed to ensure that access to the licensed premises of a M-retailer licensee will be limited to individuals who are at least 18 years of age and have a valid physician's recommendation**
  
- 3 Standards developed under this SOP will recognize that if a licensed premises is shared by an A-license and an M-license according to section 5025 of the BCC Regulations for Retailers, the licensee may allow persons identified in Steps #1 and #2 above to access the premises**

## 5401. Limited-Access Areas

The following section specifies areas of limited access

- 1 SOPs will be developed to ensure that limited-access areas are established and only authorized individuals are permitted to enter the retailer limited-access areas**

  - NOTE: Authorized individuals include individuals employed by the retailer as well as any outside vendors, contractors, or other individuals conducting business that requires access to the limited-access area
  
- 2 Standards will be developed to ensure that an individual in the retailer limited-access area who is not employed by the retailer will be escorted by the licensee's employees at all times within the retailer limited-access area**
  
- 3 All standards developed with respect to limited-access areas will include provisions to ensure that any individual who enters the retailer limited-access area will be at least 21 years of age**
  
- 4 Standards and tools will be developed to comply with the requirement that all retailers will maintain a log of all authorized individuals who are not employees of the retailer that enter the retailer limited-access area. These logs will be made available to the Bureau upon request**
  
- 5 Standards developed with respect to limited-access areas will ensure that the retailer does not receive consideration or compensation for permitting an individual to enter the retailer limited-access area**

## 5402. Retail Area

The following section specifies requirements and guidelines for access in the retail area

- 1 SOPs will be developed to ensure that individuals are granted access to the retail area only to purchase cannabis goods after the retailer or an employee of the retailer has verified that the individual is at least 21 years of age and has a valid proof of identification, or that the individual is at least 18 years of age, has valid proof of identification and a valid physician's recommendation for his or her self or for a person for whom he or she is a primary caregiver**
- 2 Standards will include provisions for acceptable forms of ID, which include the following:**

  1. A document issued by a federal, state, county, or municipal government, or a political subdivision or agency thereof, including, but not limited to, a valid motor vehicle operator's license, that contains the name, date of birth, physical description, and picture of the person; or
  2. A valid identification card issued to a member of the Armed Forces that includes a date of birth and a picture of the person; or
  3. A valid passport issued by the United States or by a foreign government
- 3 Standards developed under this SOP will recognize that a valid proof of identification must clearly indicate the age or birthdate of the individual**
- 4 Standards will be developed to ensure that either the retailer or its employees will be physically present in the retail area at all times when individuals who are not employees of the retailer are in the retail area**

## 5403. Hours of Operation

The following section specifies requirements and guidelines for hours of operation

**1 SOPs will be developed to ensure that sales are only performed between the hours of 6:00 a.m. Pacific Time and 10:00 p.m. Pacific Time**

**2 Standards will be developed to ensure that at any time the premises is not open for retail sales:**

1. The premises is securely locked with commercial-grade, non-residential door locks
2. The premises is equipped with an active alarm system which will be activated when the retailer or its employees are not on the licensed premises; and
3. Only employees and contractors of the retailer are allowed to enter the premises

## **5404. Retail Customers**

The following section specifies the parameters and definitions of retail customers

- 1** SOPs will be developed to ensure that the retailer will only sell adult-use cannabis goods to individuals who are at least 21 years of age, and medicinal cannabis goods to individuals at least 18 years of age who possess a valid physician's recommendation for his or her self or a person for whom he or she is a primary caregiver
  
- 2** Standards will be developed to ensure that identity, age and physician's recommendation if applicable are verified for each customer as required by SOP 5402 of this Manual



## 5405. Cannabis Goods Display

The following section specifies the parameters and definitions of retail customers

- 1 SOPs will be developed to ensure that cannabis goods for inspection and sale shall only be displayed in the retail area**
  
- 2 Standards will be developed to ensure that cannabis goods are not displayed in a place where they are visible from outside of the licensed premises**
  
- 3 Standards will be developed to ensure that during physical inspection by customers, cannabis goods may be removed from their packaging and placed in containers to allow for closer inspection. The containers will not be readily accessible to customers without assistance of retailer personnel. A container must be provided to the customer by the retailer or its employees, who will remain with the customer at all times that the container is being inspected by the customer**
  
- 4 Standards for the handing of cannabis goods removed from their packaging for display will be developed to ensure that such cannabis is not sold or consumed and will be destroyed according to Section 5054 of the BCC Regulations when the cannabis goods are no longer used for display**

## 5406. Cannabis Goods for Sale

The following section specifies the parameters for salable cannabis goods

**1** SOPs will be developed to ensure that cannabis goods are not made available for  sale or delivery to a customer unless:

1. The cannabis goods were received from a licensed distributor
2. It has been verified that the cannabis goods have not exceeded their expiration or sell-by date if one is provided
3. In the case of manufactured cannabis products, the product complies with all requirements of Business and Professions Code section 26130 and all other relevant laws

## **5407. Sale of Non-Cannabis Products on Premises**

The following section specifies parameters for sale of non-cannabis products on the premises

- 1 If the business desires to sell non-cannabis products on the licensed premises, standards will be developed to establish and maintain compliance with any city, county, and state laws or regulations related to those products. This provision excludes alcohol and alcohol products and tobacco and tobacco products from sale at any licensed premises**

## 5408. Live Plants

The following section refers to the sale of live plants

**1 Standards for live plant sales will be developed as needed to ensure that only live,  immature cannabis plants and seeds are sold and only if all of the following requirements are met:**

1. The plant is not flowering;
2. The plant or seed was purchased from a nursery that holds a valid Type-4 license under the Act
3. A label is affixed to the plant or package containing any seeds which states "This product has not been tested pursuant to Medicinal and Adult-Use Cannabis Regulation and SafetyAct."

**2 Standards regarding live plants will also be developed as needed to ensure the  following:**

1. The sale of any other live plants is prohibited
2. The application or use of any pesticide on or around live plants is strictly prohibited



## 5409. Daily Limits

The following section specifies the daily limits on sales to the two classes of cannabis customers

**1 SOPs will be developed to ensure that the following daily limits are enforced for**   
**all adult-use cannabis customers:**

- No more than 28.5 grams of non-concentrated cannabis in a single day to a single customer
- No more than 8 grams of concentrated cannabis as defined in Business and Professions Code section 26001, including concentrated cannabis contained in cannabis products, in a single day to a single customer
- No more than 6 immature cannabis plants, in a single day to a single customer

**2 Standards will be developed to ensure that the following daily limits are enforced**   
**for all medicinal cannabis customers:**

- No more than eight ounces of medicinal cannabis in a single day to a single medicinal cannabis customer

## 5410. Customer Return of Cannabis Goods

The following section defines the parameters for customer return of cannabis goods

**1 SOPs will be developed to ensure that customer returns of cannabis goods are handled in compliance with all department regulations**

- NOTE: For the purposes of this section, “customer return” means a customer’s return of cannabis goods that were purchased from a retailer, back to the retailer the cannabis goods were purchased from

**2 Standards will be developed to reflect the retailers disposition on returns of cannabis goods. A retailer may accept customer returns of cannabis goods that were previously sold to a customer**

**3 Standards regarding return of cannabis goods will be developed as necessary to reflect that returned cannabis goods will not be resold and will be subject to the disposal and destruction requirements found in Sections 5054 and 5055 of the BCC Regulations**

**4 Standards will also be developed to ensure that cannabis goods which are abandoned on the retail premises are treated as a customer return and subject to the disposal and destruction policy per Step #3 above**

## 5411. Free Cannabis Goods

The following section outlines the requirements and limitations for free cannabis goods offered by the retailer

**1 SOPs will be developed to ensure that free cannabis goods will not be provided by the business to any person, nor will individuals who are not employed by the business to provide free cannabis goods to any person on the licensed premises**

**2 Standards will be developed to ensure that regardless of section 1 above, in order to provide access to medicinal cannabis patients who have difficulty accessing medicinal cannabis goods, a licensee who holds a Type 10-Retailer M-license, a Type 9-Retailer Non-storefront-M license, or a microbusiness M-license which allows for retail sales, may provide free medicinal cannabis goods if all of the following criteria are met:**

1. Free cannabis goods are provided only to a medicinal cannabis patient or primary caregiver for the patient in possession of a valid identification card issued under Section 11362.71 of the Health and Safety Code
2. The cannabis goods comply with all applicable laboratory testing requirements under this division
3. Prior to being provided to the patient or primary caregiver, the cannabis goods have been properly recorded in the track and trace system as belonging to the retailer
4. The cannabis goods shall not leave the licensed premises unless placed in an opaque package as required for purchased cannabis goods under Business and Professions Code section 26070.1
5. The cannabis goods will be applied toward the daily limit purchased by a medicinal cannabis customer according to SOP 5409 of this Manual
6. The transaction will be properly recorded in the retailer's inventory records and the track and trace system

**3**

**Standards developed in accordance with this SOP will also consider that in addition to the provision of free cannabis goods in Step #2 above, a licensee may donate cannabis goods and the use of equipment in compliance with any compassionate use, equality, or other similar program administered by a local jurisdiction**





## 5412. Packaging and Labeling

The following section specifies detailed requirements of packaging and labeling

- 1 Adherence to this SOP indicates that this retailer does not accept, possess, or sell  cannabis goods that are not packaged as they will be sold at final sale, in compliance with the division of Retail Requirements of the BCC**
- 2 Adherence to this SOP indicates that this retailer does not package or label  cannabis goods**

## **5413. Exit Packaging**

The following section specifies detailed requirements of exit packaging

- 1 Adherence to this SOP indicates that this retailer provides and opaque exit package for each customer purchase so that all products may discreetly exit the premises without being visible to the public**

## 5414. Type 9-Non-Storefront Retailer

The following section outlines the parameters of the Type-9-Non-Storefront Retailer license

**1 The following information will be referred to for questions regarding the activities authorized under a Type 9-Non-Storefront Retailer license:**



1. A Type 9-Non-Storefront Retailer licensee is authorized to conduct retail cannabis sales exclusively by delivery as defined in Business and Professions Code section 26001(p)
2. A complete application for a Type 9-Non-Storefront Retailer license includes all the information required in an application for a Type 10-Retailer license
3. A Type 9-Non-Storefront Retailer licensee will comply with all the requirements applicable to Type 10-Retailer licensees, except for those provisions related to public access to the premises
4. The licensed premises of a Type 9-Non-Storefront Retailer licensee will be closed to the public

## 5415. Delivery

The following section outlines the requirements specific to delivery of cannabis goods

- 1 SOPs will be created to ensure that all deliveries of cannabis goods are performed by a delivery employee of the business**
  
- 2 Standards will be created to ensure that each delivery employee hired by the business will be at least 21 years of age**
  
- 3 Standards will be created to ensure that all deliveries of cannabis goods will be made in person. A delivery of cannabis goods will not be made through the use of an unmanned vehicle**
  
- 4 Standards will be developed with adequate tracking procedures to ensure that the process of delivery begins when the delivery employee leaves the retailer's licensed premises with the cannabis goods for delivery, and ends when the delivery employee returns to the retailer's licensed premises after delivering the cannabis goods to the customer(s)**
  
- 5 Standards will be developed to ensure that delivery employees hired by the business will, during deliveries, carry a copy of the retailer's current license, the employee's government-issued identification, and an identification badge provided by the employer according to section 5043 of the BCC regulations**
  
- 6 Standards will be developed to ensure the creation and maintenance of an accurate list of delivery employees hired by the business**

## **5416. Delivery to a Physical Address**

The following section specifies requirements for delivery locations

- 1 SOPs will be developed to ensure that cannabis goods delivered by the business are delivered only to verified physical addresses in California**
  
- 2 Standards will be developed to ensure that delivery employees will not leave the State of California while possessing cannabis goods**
  
- 3 Standards will be developed to ensure that delivery drivers do not deliver goods to any address located on publicly owned land or any address on land or in a building leased by a public agency. This prohibition applies to land held in trust by the United States for a tribe or an individual tribal member unless the delivery is authorized by and consistent with applicable tribal law**



## 5417. Methods of Delivery

The following section specifies permitted methods of delivery

- 1** SOPs will be developed to ensure that delivery employees of the business carrying cannabis goods for delivery, will only travel in an enclosed motor vehicle operated by a delivery employee of the licensee/business
- 2** Standards will be created to ensure that while carrying cannabis goods for delivery, a retailer's delivery employee will ensure the cannabis goods are not visible to the public
- 3** Standards will be created to ensure that a delivery driver hired by the business will not leave cannabis goods in an unattended motor vehicle unless the motor vehicle is locked and equipped with an active vehicle alarm system
- 4** Standards will be developed to ensure that vehicles used for delivery of cannabis goods will be outfitted with a dedicated Global Positioning System (GPS) device for identifying the geographic location of the delivery vehicle. A dedicated GPS device must be owned by the licensee and used for delivery only. The device shall be either permanently or temporarily affixed to the delivery vehicle and shall remain active and inside of the delivery vehicle at all times during delivery. At all times, the retailer shall be able to identify the geographic location of all delivery vehicles that are making deliveries for the retailer and shall provide that information to the Bureau upon request

**5 Standards will be developed to ensure compliance with requests by the bureau**   
**which require the business to provide the Bureau with information regarding any motor vehicles used for the delivery of cannabis goods, including the vehicle's make, model, color, Vehicle Identification Number, license plate number and Department of Motor Vehicle's registration**

**6 Standards will be developed to ensure adequate preparation of delivery drivers**   
**for compliance with the following:**

- Any motor vehicle used by a retailer to deliver cannabis goods is subject to inspection by the Bureau. Vehicles used to deliver cannabis goods may be stopped and inspected by the Bureau at any licensed premises or during delivery

## **5418. Cannabis Goods Carried During Delivery**

The following section defines the limits of cannabis goods carried during delivery

- 1 SOPs pertaining to deliveries will be created to ensure that delivery drivers hired  by the business will not carry cannabis goods worth in excess of \$3,000 at any time. This value will be determined using the current retail price of all cannabis goods carried by the delivery employee**

## **5419. Cannabis Consumption During Delivery**

The following section defines the limits of cannabis consumption during delivery

- 1 SOPs pertaining to deliveries will be created to ensure that delivery drivers hired by the business will not consume cannabis goods while delivery cannabis goods to consumers**

## 5420. Delivery Request Receipt

The following section specifies what should be on the delivery request receipt

**1 SOPs will be created to ensure that a delivery request receipt is prepared for each delivery of cannabis goods. Each receipt will contain the following:**

1. The name and address of the retailer
2. The first name and employee number of the retailer's delivery employee who delivered the order
3. The first name and employee number of the retailer's employee who prepared the order for delivery
4. The first name of the customer and a retailer assigned customer number for the person who requested the delivery
5. The date and time the delivery request was made
6. The delivery address
7. A detailed description of all cannabis goods requested for delivery. The description will include the weight, volume, or any other accurate measure of the amount of any cannabis goods requested
8. The total amount paid for the delivery, including any taxes, fees, the cost of the cannabis goods, and any other charges related to the delivery
9. Upon delivery, the date and time the delivery was made, and the signature of the customer who received the delivery

**2 Standards will be developed to ensure that at the time of the delivery, the delivery employee will provide the customer, who placed the order a copy of the delivery request receipt. The delivery employee will retain a signed copy of the delivery request receipt for the retailer's records**



## 5421. Delivery Route

The following section defines the parameters of an acceptable delivery route

**1** SOPs will be developed to ensure that delivery drivers follow only approved routes to and from the licensed facility. For the purposes of this SOP, the following apply:



1. While making deliveries of cannabis goods, a retailer's delivery employee shall only travel from the retailer's licensed premises to the delivery address;
2. From one delivery address to another delivery address; or
3. From a delivery address back to the retailer's licensed premises.
4. A delivery employee of a retailer will not deviate from the delivery path described in this section, except for necessary rest, fuel, or vehicle repair stops, or because road conditions make continued use of the route unsafe, impossible, or impracticable

## 5422. Receiving Shipments of Inventory

The following section specifies regulations applicable to inventory shipments received by the business

- 1 SOPs will be developed to ensure that shipments of cannabis goods are received only from a distributor**
  
- 2 Standards will be developed to ensure that shipments of cannabis goods are accepted by the business only between the hours of 6:00 a.m. Pacific Time to 10:00 p.m. Pacific Time**
  
- 3 Standards will be developed to ensure that during business hours, shipments of cannabis goods will not enter the premises through an entrance or exit that is available for use by the public**

## 5423. Inventory Documentation

The following section specifies the requirements for inventory documentation

**1 SOPs will be developed to ensure that accurate record of the business inventory  is created and maintained. This record is subject to inspection by the Bureau and must be provided upon request. The business will keep a record of the following information for all cannabis goods held in the business' inventory:**

1. A description of each item in the retailer's inventory. This description will be such that the cannabis goods can easily be identified
2. An accurate measurement of the quantity of the item
3. The date and time the cannabis goods were received by the retailer
4. The sell-by or expiration date on any cannabis goods, if any
5. The name and license number of the licensee that delivered the cannabis goods to the retailer
6. The name and license number of the distributor that provided the cannabis goods to the retailer
7. The price the retailer paid for the cannabis goods, including taxes, delivery costs, or any other costs

## 5424. Inventory Reconciliation

The following section specifies the requirements for inventory reconciliation

- 1 SOPs will be developed to ensure that reconciliation of retail inventory is performed at least once every 14 days**
  
- 2 Standards will be developed to ensure that inventory records will be verified and matched with a physical inspection of inventory to maintain consistent recording**
  
- 3 Standards will be developed to ensure that results of inventory reconciliation will be retained in the business records and will be made available to the Bureau upon request**
  
- 4 Standards will be developed to ensure that if any evidence of theft, diversion, or loss is identified, the Bureau and law enforcement will be notified according to Section 5036 of the BCC Regulations**
  
- 5 Standards will be developed to ensure that if a significant discrepancy as defined in Section 5034 of the BCC Regulations is discovered between the retailer's physical inventory and inventory records, the retailer shall notify the Bureau and law enforcement in accordance with Section 5036 of the BCC Regulations**

## 5425. Record of Sales

The following section specifies the requirements for recording sales

**1** **SOPs will be developed to ensure that the business maintains an accurate record of sales for every sale made to a customer. A record of medicinal cannabis goods sale will contain the following information:**

- The first name and employee number of the retailer employee who processed the sale
- The first name of the customer and a retailer assigned customer number for the person who made the purchase
- The date and time of the transaction
- A list of all the cannabis goods purchased, including the quantity purchased
- The total amount paid for the sale including the individual prices paid for each cannabis good purchased and any amounts paid for taxes



## 5426. Records

The following section specifies the appropriate reference for specifics related to record maintenance

- 1 **SOPs will be developed to ensure that all retailer-specific records in this Manual will be maintained in accordance with Section 5037 of the BCC Regulations**



## Armed Robbery Prevention and Procedures

Armed robbery is one of the most serious and potentially dangerous crimes committed in the United States today. A robber commits a hold-up because he or she believes that their profit will be worth the risk. By decreasing the possible profit and increasing the risk of apprehension, potential victims can reduce their chance of becoming a target. Personal safety is always the most important consideration when planning how to react to an armed robbery. This document provides basic information that can and will diminish the chance of becoming a victim

### What to Do Before You Are Robbed

Businesses must face the possibility of robbery on their premises realistically, and they should give security training a high priority. Employees will be trained in the latest methods of robbery prevention, which will improve their chances for safety and their ability to provide information that could help in the apprehension of the criminal. In addition, this preparation can lessen the emotional after effects of being involved in an armed robbery.

- Opening and closing procedures should be established. These could include:

Have several employees present when opening and closing the business.

Inspect the business for forcible entry before entering the business. – One employee searches the premises before admitting others. If all is clear, the employee entering the facility first can signal the companion with some prearranged sign. – At closing make sure no one is hiding in the business. – At closing one employee can enter the parking lot first and can signal the companion with some prearranged sign if it is safe.

- Every business should operate with a cash protection system. Each employee handling cash should be trained in the various possible types of attack, and the employee should follow good cash handling practices. The cash system should work two ways by protecting both lives and money. Periodic checks should be made to be sure all cash protection rules are being followed. By following these cash handling procedures, the business will make it a less attractive “mark” and limit the robber’s profit while reducing the business’ potential losses.

Keep a minimum of easily accessible cash on hand, and in the safe. Use a money safe that requires more than one employee to open. Always lock money safes after the day’s operating funds are obtained. Serious loss can be reduced by having special separately locked inner compartments or lockers where the change funds are maintained. Dual control of safes and two-key inner compartment money safes require at least two people to open the door, thus helping to prevent robberies. Try not to open the cash safe too often.

Make sure employees do not display large amounts of money. This procedure should be accomplished in a designated secured office or other secure area less visible and vulnerable.



Do not allow employees to count large amounts of cash in areas visible either to the public or to other employees. Large amounts of money exposed to view represent a temptation not only to robbers but to employees and customers alike

Disguise the currency bags in plain wrappings or in another container (i.e., brief case, etc.) – Vary the personnel doing the deposit, if possible. – Vary the vehicle used. – Request police or armed guard protection when handling or transporting large amounts of money.

- Physical security measures include:

Maintaining a well-lighted interior visible from the street. Make sure signs, displays, plants, etc. do not obstruct the view from the street of the customer service area. Maintaining visibility into the business establishment at all times is important.

Storage rooms that have a lock that can be opened from the inside. Robbers sometimes lock employees in storage rooms. Hide a key in the room if the lock cannot be opened from the inside.

- Marking the edge of the doorway at varying heights to identify the height of a robber.
- Mechanisms that permit employees to have a complete view of their surroundings such as convex mirrors, an elevated vantage point, and placement of the employee area so that it is clearly visible outside the establishment serve as deterrents.
- Install barriers to keep unauthorized persons out of these restricted areas. – For secure areas, use doors and gates with latches that automatically lock on closing.
- Install a timed delay switch to turn off exterior lights after the employees have gone for the night. – Prominently displayed surveillance camera equipment. Be sure to have the equipment serviced regularly and to only use video tapes the amount of times recommended by the manufacturer.
- Use a dual key, drop or delay-action time-lock safe. – A silent alarm system. This alarm system:
  - Could incorporate a daytime holdup feature that reports to a remote supervised area. Make sure employees know how and when, and when not, to activate the alarm.
  - Could be unobtrusively activated by an employee who is forced to open the safe or vault.
  - Including standby power and transmission method, should be tested periodically. When accidentally set off or when it malfunctions, it should be reported immediately to the police to insure an adequate response.
- Should be taught to new employees and periodically reviewed with those employees who need to know.
- Seldom used rear and side doors, windows, and other accessible openings should be kept locked always. Doors should have viewers. Doors used for deliveries should be locked when not in use.
- Maintain good exterior lighting. Adequate outside lighting of the parking area and approach to the business during nighttime hours of operation enhances employee protection. Surveillance lighting to detect and observe pedestrian and vehicular entrances of the business can also help. Adequate lighting within and outside the establishment makes the facility less appealing to a potential robber by making detection more likely.



- All shrubbery and trees, that a criminal could use to hide, should be cut back and maintained.

In certain high-risk areas or businesses, consideration should be given to the use of additional deterrents. These may include:

- The presence of off-duty police or uniformed guards. The use of an armored car service for delivery and pick-up of cash.
- Maintain a list of emergency contact telephone numbers near the telephone. Have witness description forms available for employees and witnesses to complete after a robbery has occurred.
- Vary lunch hours and coffee breaks so several employees are always on duty.
- Employees should be trained to watch for and report suspicious actions of people inside and immediately outside the premises. Don't hesitate to call the police when worried about a potential risk. Should the person leave before the officer's arrival, write down the description of the suspect and their vehicle for possible police use. A suspicious person that is seen today may turn out to be the robber who returns tomorrow. Examples of suspicious activity could include:
  - Persons monitoring business operations.
  - Persons asking about closing times, volume of business, the amount of money on hand, etc.
  - Persons who appear to just loiter in the area checking the business layout and operations.
  - Persons who may be waiting for a lull in activity and fewer customers.
- Give every customer entering the business a friendly greeting. Look each customer directly in the eyes. A robber does not want to be identified and such human contact may spoil it for some would-be robbers.
- Require employees to ask for the identification of workers, repair people, guards, police officers, etc. before permitting entry into secured areas.
- The counter or work area should be cleaned regularly to remove old fingerprints. This increases the possibilities that a robber may leave a readable print behind. Oil or wax-based cleaners should not be used.
- Try to have at least two employees on duty always. Employing two people is a form of "target hardening" because it may make a robbery more difficult to complete and, therefore, more unsuitable to a potential robber.
- Don't be tempted to use phony signs or equipment. The use of phony surveillance cameras, for example, can destroy the credibility of all other security precautions. Robbers soon learn to ignore them.
- Many police departments have procedures for alarm verification and robbery response. Finding out what they are is advisable so that the employees will know what to expect in case of an armed robbery.

### Procedures During a Robbery

Proper employee training of the procedures to follow during a robbery is vital to surviving the confrontation. Conduct documented training and discussion periods so that every employee knows their part and has an opportunity to ask questions. A few minutes of brief review on a regular basis will help to insure the proper reaction in case of a robbery. The overriding consideration in dealing with a robbery is to reduce the possibility of injury.

- Do not resist the robber. The product or money is not worth risking a life. Take no action that would jeopardize the safety of employees or customers. Cooperate with the robber and do not try to become a hero. In most situations, robbers almost never hurt anyone who cooperates.
- Do not use or encourage the use of weapons against the robber. Introducing another weapon into the situation increases the chances of someone becoming injured during the robbery. No amount of product or money is worth the risk of endangering a person's life.
- Try to inform the robber of any surprises. If someone is expected back soon or if you must reach or move in any way, tell the robber what to expect so they will not be startled. A suspicious move by an employee may trigger a violent reaction endangering the lives of many people.
- Follow the robber's commands, but do not volunteer to help. The longer the robbery takes, the more nervous the robber may become and more apt to become violent.
- If the robber demands a specific amount of product or money, only give them what they demand.
- Try to keep customers and employees calm during the robbery.
- If the robber displays a firearm or claims to have one, consider it loaded and that they would use it.
- Activate the holdup alarm, if possible, only if it can be safely done without being obvious to the robber.
- Try to alert other employees of the situation by using prearranged signals.
- Be observant. Plan to be a good witness. Try to notice as much as possible about the robber. Make mental notes of the following:
  - The number of robbers.
  - The robber's physical characteristics, including: race, sex, age, height, weight, facial characteristics (head shape, color of hair, color of eyes, shape of eyes, nose and mouth, etc.) speech patterns (i.e., accents), scars, marks and/or deformities, right or left-handed.
  - The robber's clothing description
  - Any names used by the robbers
  - Any peculiarities exhibited by the robber (i.e., smelled of alcohol, appeared to be "high" on drugs, etc.).
  - Description of any weapons used. Try to notice barrel length, barrel color, color of grips, whether a pistol is automatic or a revolver.
  - If the robber uses a written note, try to place it out of sight to retain it as evidence.
  - After the robber has the product or money, offer to have employees and customers lie down instead of waiting for the robber to decide what to do, such as knocking you down or tying you up.

### Procedures After the Robbery

If the following procedures are adhered to after a robbery, the employee will be in a better position to provide information to assist law enforcement officers in arresting the perpetrator, and more importantly, in protecting the employee and innocent customers from harm. These are:

- Establish which personnel will take certain actions if a robbery occurs. Decide now which employee will lock the doors, who will call the police, who will care for the injured, who will look

for the getaway car, who will protect the evidence, etc. Don't assume these jobs will be done automatically.

- Do not chase or follow the robber. The robber may shoot at any pursuers or the police may shoot at you, too, thinking you are a robber.
- Secure the doors so the robbers cannot reenter the facility. Stop business operations and place a sign on the door advising employees or customers that the facility is "Temporarily closed due to an emergency." Do not let anyone in, except emergency personnel.
- Call the police immediately. Be sure to tell them if anyone is injured so they may dispatch medical personnel if necessary. Give the police the time of the robber's departure, their description and direction and method of travel. Stay on the telephone until they tell you its okay to hang up. The speed of reporting is critical to the apprehension of the offender.
- Care for any injured people.
- If it can be safely accomplished as the robbers leave, try to note their method of escape along with the direction of travel. If a vehicle is used, try to find out the make, color, type, license number and the state of registration.
- Try to preserve any potential evidence. Protect the scene of the crime and do not touch anything the robber may have touched. Keep people out of the area.
- Write down the description of the robber. Witness description forms can be available to fill descriptive data and other remarks or if not available, use any available paper. Do not "compare notes" with others until a police officer arrives and conducts the necessary interviews.
- Ask witnesses to remain until the police arrive. If they insist on leaving, try to obtain their names and addresses.
- Contact any other individuals who may need to be contacted (i.e. owners, security, etc.). Emergency telephone numbers should be accessible, and the notification policy clearly established.
- Do not discuss the crime with outsiders until police give permission to do so. Refer all questions to the police.
- Do not tell or estimate how much product or money was lost to the robber unless absolutely necessary. The police can list the amount taken as an "undetermined amount of product and/or cash" until the exact amount is determined in an audit. Find out and record anything else that may have been stolen. If an exact amount of product and/or cash taken during the robbery should be released to the media and they report a large loss, other robbers could be attracted to the business or others in the chain. Do not speak to the media.
- Assist the investigating officers in every way possible. Cooperate with the police by being available for interviews, not being reluctant to identify suspects and giving evidence in court when notified to do so.





# Louie's Gouie's

## Injury & Illness Prevention Plan

DRAFT Copy

*Prepared June 19, 2018*



# Table of Contents

- Illness Prevention and Safety Commitment..... 3
- Injury and Illness Prevention Program ..... 4
- Illness Prevention Policies [RESERVED] ..... 5
- SAMPLE FORMS ..... 6
- IIPP SAFETY REPRESENTATIVE DESIGNATION FORM..... 7
- ACKNOWLEDGEMENT OF RECEIPT AND REVIEW OF CODE OF SAFE PRACTICES ..... 8
- SAFETY RULE VIOLATION NOTICE ..... 9
- WORKPLACE SAFETY SUGGESTIONS FORM..... 10
- MANAGERS AND SUPERVISOR SAFETY MEETING REPORT..... 11



## Illness Prevention and Safety Commitment

GTS Management (“the Company”) is firmly committed to a safety policy enabling all work activities to be carried out safely, and with all possible measures taken to remove (or at least reduce) risks to the health, safety and welfare of workers, contractors, authorized visitors, and anyone else who may be affected by our operations.

The following safety policy manual is provided to assist Louie’s Gouie’s and employees in complying with the requirements of the company’s safety policy and CAL OSHA, as well as to provide other helpful information. It is not intended to supersede the requirements of the standards.

This manual demonstrates the commitment of The Company to both management and employee health and safety. Louie’s Gouie’s aims to remove or reduce the risks to the health, safety and welfare of all workers, contractors and visitors, and anyone else who may be affected by our business operations. The goal is to ensure all work activities are done safely.

Management (the supervisor and / or manager) is responsible for providing and maintaining:

- A safe working environment
- Safe systems of work
- Plants and substances in safe condition
- Facilities for the welfare of all workers
- Any information, instruction, training and supervision needed to make sure that all workers are safe from injury and risks to their health

Employees are responsible for:

- Ensuring their own personal health and safety, and that of others in the workplace
- Complying with any reasonable directions (such as safe work procedures, wearing personal protective equipment (PPE) given by management for health and safety

CEO/President \_\_\_\_\_(signature) 3



## Injury and Illness Prevention Program

### Safety Policy Statement

- It is the policy of Louie's Gouie's or ("the Company") that injury and illness prevention will be considered of primary importance in all phases of operation and administration.
- It is the intention of the company's top management to provide safe and healthy working conditions and to establish and insist upon safe practices at all times by all employees.
- The prevention of injury and illness is an objective affecting all levels of the organization and its activities. It is therefore, a basic requirement that each supervisor make the safety of employees an integral part of his or her regular management function. It is equally the duty of each employee to accept and follow established safety regulations and procedures.
- Every effort will be made to provide adequate training to employees. However, if an employee is ever in doubt how to do a job safely, it is their duty to ask a qualified person for assistance.
- Employees are expected to assist management in injury and illness prevention activities. Unsafe conditions must be reported. Fellow employees that need help should be assisted. Everyone is responsible for the housekeeping duties that pertain to their jobs.
- Any injury that occurs on the job, even a slight cut or strain, must be reported to management as soon as possible. In no circumstance, except emergency, should an employee leave a shift without reporting an injury that occurred.
- The company motto regarding injury and illness prevention is: "When you have an injury and illness, everyone loses; you, your family, your fellow workers, and the company. Please work safely. It's good for everyone."



## **Illness Prevention Policies [RESERVED]**

Louie's Gouie's will continue to develop its Illness Prevention Plan as the Company grows and takes on staff and functionality, with a continually reflective and improving system of processes and procedures that address all necessary areas of concern. Upon completion of the Company framework and licensure, Management will be focused on the development of the following policies and related procedures, per State and local requirements:

- ✚ Accountability for Jobsite Safety
- ✚ IIPP Safety Representative Duties and Responsibilities
- ✚ Jobsite Subcontractors and Supplies Safety and Responsibilities
- ✚ Jobsite Employees Safety and Responsibilities
- ✚ Owners, and Other Jobsite Visitors Safety and Responsibilities
- ✚ Employee and Subcontractor Compliance
  - Positive Recognition for Workers Who Follow Safe Jobsite Practices
- ✚ Code of Safe Practices
  - General Office
- ✚ Code of Safe Practices
  - General Jobsite
- ✚ Use of Tools and Equipment
- ✚ Machinery and Vehicles
- ✚ Driver Safety Procedure:
- ✚ Disciplinary Action for Safety Violators
- ✚ Safety Communication Policy



## **SAMPLE FORMS**





## IIPP SAFETY REPRESENTATIVE DESIGNATION FORM

The person with the authority and responsibility for our company Injury and Illness Prevention Program (IIPP) is \_\_\_\_\_. Whenever and wherever appropriate, \_\_\_\_\_, as the IIPP Safety Representative, may delegate safety-related duties to managers, supervisors or lead, or to any jobsite workers.

In addition to the above, the IIPP Safety Representative will see to it that the Company managers and supervisors will assume their respective responsibility for the safety and health of their assigned staff. Those responsibilities will include, but will not be limited to:

- Review safety policies and procedures; become familiar with functions and responsibilities of supervision, and the interrelationships with other departments.
- Develop a sound technical knowledge of all applicable Cal/OSHA Safety Orders and Regulations; in addition to keeping current with requirements made by other government agencies.
- Maintain an occupational training program covering hazards basic to all types of employment and those unique to each worker's job assignment.
- Correct unsafe and unhealthy work practices in a timely manner.
- Schedule and conduct regular safety training meetings with all employees.
- Perform first-aid duties as required, which will include maintaining appropriate first-aid supplies, dissemination of emergency procedures and providing first-aid training.
- Keep records of all employee training, corrections of unsafe conditions, dates and results of workplace inspections. Submit all documentation to Human Resources for company recordkeeping.



## **ACKNOWLEDGEMENT OF RECEIPT AND REVIEW OF CODE OF SAFE PRACTICES**

To all employees:

Attached is a copy of the code of safe practices. These guidelines are provided for your safety. It is the responsibility of Safety Representative to provide and review this code with each employee. It is the employee's responsibility to read and comply with this code. The attached copy of the code of safety practices are for you to keep. Please sign and date below and return this page to your manager or supervisor.  
I have read and understand the code of safe practices.

\_\_\_\_\_  
Employee Signature

\_\_\_\_\_  
Date



**SAFETY RULE VIOLATION NOTICE**

Date of safety violation \_\_\_\_\_  
Worker's involved in the violation \_\_\_\_\_  
Employee's Company \_\_\_\_\_  
Company safety rule(s) violated \_\_\_\_\_  
Corrective action taken by Superintendent \_\_\_\_\_  
This is this employee's (first) (second) (third) (fourth) safety violation.  
Disciplinary action suggested \_\_\_\_\_  
Employee's Signature \_\_\_\_\_ Date \_\_\_\_\_  
Manager's Signature \_\_\_\_\_ Date \_\_\_\_\_  
Copy to employee (yes) (no) Date presented \_\_\_\_\_



**WORKPLACE SAFETY SUGGESTIONS FORM**

Use this form to report any hazards you see, or to make any suggestions about improving safety in the facility. You need not sign this form if you do not want to. However, only signed forms are eligible for safety suggestion awards.

Submitted by (Optional) \_\_\_\_\_ Company \_\_\_\_\_

I have noticed the following safety/health hazard(s): \_\_\_\_\_

Location of the problem: \_\_\_\_\_

I have the following suggestion(s) for correcting the above-mentioned hazard(s), or for improving safety in this facility:

Reviewed by \_\_\_\_\_ on (date) \_\_\_\_\_



## MANAGERS AND SUPERVISOR SAFETY MEETING REPORT

Jobsite Name \_\_\_\_\_

Location \_\_\_\_\_

Date \_\_\_\_\_ Meeting Coordinator \_\_\_\_\_

Lessons to be learned from recent accidents and near misses: \_\_\_\_\_

Unresolved issues from the last walk-thru safety inspection: \_\_\_\_\_

New safety suggestions: \_\_\_\_\_

Recommended action taken: \_\_\_\_\_

Employees in attendance:

_____	_____
_____	_____
_____	_____
_____	_____
_____	_____

Guests:

_____	_____
_____	_____

Report reviewed by: \_\_\_\_\_ Date: \_\_\_\_\_

Fire Suppression & Safety Plan - DRAFT

Prepared for

Louie's Gouie's

316 Yolanda Avenue

Santa, Rosa CA

APN #044-072-005







## Table of Contents

- I. Policy Statement
- II. Authority and Scope
- III. Plan Administration
- IV. Plan Review and Update
- V. Definitions
- VI. Major Fire Hazards, Potential Ignition Sources, Controls, and Fire Control Equipment
- VII. Housekeeping
- VIII. Maintenance of Ignition Sources
- IX. Maintenance of Fire Prevention and Suppression Systems and Equipment
- X. Employee Training
- XI. Fire Evacuation Procedures
- XII. Recordkeeping



## Fire Prevention Plan

### I. Policy Statement

**Louie's Gouie's ("the Company")** will provide its employees and other personnel with a clear plan to prevent the loss of life and property by fire. The plan will comply with applicable fire prevention regulations.

### II. Authority and Scope

**Regulation:** 29 CFR 1910.39, Fire Prevention Plans.

**Scope:** This plan covers all work operations at Louie's Gouie's where fire hazards or the potential for fires may be present. This FPP provides all facility personnel with basic information about major fire hazards and fire prevention methods in accordance with federal and state regulations and company policy.

### III. Plan Administration

Table below provides the roles and contact information for the administration of the FPP.

**Table —Plan Contact Information**

Task	Contact Person	Contact Information
FPP Administrator	Operations Manager	Work: Mobile: TBD
Fuel Source Control	Operations Manager	Work: Mobile:TBD
Ignition Source Maintenance	Operations Manager	Work: Mobile:TBD
Fire Control Equipment	Operations Manager	Work: Mobile:TBD
Housekeeping	Operations Manager	Work: Mobile:TBD
Employee Training	Operations Manager	Work: Mobile:TBD
Emergency Services	Operations Manager Licensee	Work: Mobile:TBD

**FPP Administrator.** The FPP administrator is responsible for all elements of the FPP and has the authority to make necessary decisions to ensure its implementation. The administrator will periodically audit the FPP as necessary to ensure its effectiveness.

### Operations Manager



- Has access to the controls for all fuel sources at the facility and is responsible for disconnecting them during an emergency;
- Maintains ignition source equipment to ensure that such equipment is operating properly;
- Is responsible for the inspection and maintenance of fire control equipment;
- Is responsible for controlling the accumulation of flammable and combustible waste materials;
- Is responsible for training employees to understand and implement the elements of the FPP;
- Is responsible for providing emergency services.

#### **IV. Plan Review and Update**

The FPP will be reviewed annually, and updated when:

- New hazards are identified and or existing hazards change.
- There are changes to the fire protection systems.
- There are changes to fire prevention procedures.

#### **V. Definitions**

*Exit*—the portion of an exit route that is generally separated from other areas to provide a protected way of travel to the exit discharge. An example of an exit is a 2-hour fire resistance-rated enclosed stairway that leads from a designated floor of an office building to the outside of the building.

*Exit route*—a continuous and unobstructed path of exit travel from any point within a workplace to a place of safety (including refuge areas). An exit route consists of three parts: the exit access; the exit; and the exit discharge. (An exit route includes all vertical and horizontal areas along the route.)

*Fire Hazard* - include all types of live flames, causes of sparks, hot objects, and chemicals that are potential for ignition, or that can aggravate a fire to become large and uncontrolled. Fire hazards also include all types of potential threats to fire prevention practices, firefighting, built-in fire safety systems and situations that restrict the escape of people from an affected building or area in the event of a fire.

#### **VI. Major Fire Hazards, Potential Ignition Sources, Controls, and Fire Control Equipment**

Table below contains a list of the major workplace fire hazards and potential ignition sources at the facility, their proper handling/storage and control procedures, and the fire protection equipment or systems used to prevent, control, or extinguish fires.



**Table —Fire Hazards, Sources, and Fire Control**

<b>Fuel Source Hazard</b>	<b>Ignition Source Hazard</b>	<b>Handling/Storage/ Control Procedure</b>	<b>Fire Protection System/Equipment</b>
<i>gases, chemicals, oily rags, office trash, combustible wastes, frayed electrical cords</i>	<i>smoking, electrical equipment, chemicals, gases, hot work (welding, etc.), flame-producing equipment]</i>	<i>no smoking, no hot work, ventilation, closed containers, chemical segregation,</i>	<i>sprinklers, smoke detectors, fire extinguishers (A, B, C), fire alarm and monitoring system</i>
<i>dried plants and leaves</i>	<i>fire sparks</i>	<i>no smoking, no hot work, no frayed electrical cords, no mixing of chemicals without proper safety training</i>	<i>sprinklers, smoke detectors, fire extinguishers (A, B, C), fire alarm and monitoring system</i>
<i>Chemicals and gases</i>	<i>fire sparks, chemical reaction from mixing chemicals</i>	<i>no smoking, no hot work, no frayed electrical cords, no mixing of chemicals without proper safety training</i>	<i>sprinklers, smoke detectors, fire extinguishers (A, B, C), fire alarm and monitoring system</i>
<i>Electrical Outlet Overload</i>	<i>electric sparks and fire</i>	<i>do not overload electrical outlets</i>	<i>sprinklers, smoke detectors, fire extinguishers (A, B, C), fire alarm and monitoring system</i>

### VII. Housekeeping

- Flammable and combustible materials and residues will be controlled so that they do not cause or contribute to a fire emergency. See Table above for a list of fuel source hazards and fire prevention measures. This list is not all inclusive.
- All chemicals must be stored in the proper sealed labeled containers in the assigned storage area. Chemicals are not to be mixed without the appropriate safety training.
- All work areas must be kept clean and orderly with no garbage, papers, waste products, open combustible chemicals, spills must be cleaned according to SDS sheet manual.
- Electrical cords must be in good condition and must not be an electrical or trip and fall hazard.
- Employees may not leave open chemical containers.
- Employees must clean and organize their work areas prior to leaving at the end of the work day.

### VIII. Maintenance of Ignition Sources

Equipment and systems installed on heat- or ignition-producing equipment and processes will be maintained to prevent the accidental ignition of flammable and combustible materials. See Table above for a list of ignition-source hazards and fire prevention measures.

#### **Extension cords.**



Electric extension cords will be inspected before each use and kept in good condition. Employees will not yank cords from electrical outlets. Tools and equipment that require grounding will be of the three-wire grounded-connection type. Never use extension cords to replace permanent wiring. If an extension cord is used for temporary wiring, it must be listed by Underwriters Laboratories or another recognized testing laboratory. Avoid kinking or excessive bending of the cord; broken strands may pierce the insulated covering and become a shock or short-circuit hazard.]

## **IX. Maintenance of Fire Prevention and Suppression Systems and Equipment**

Fire prevention and suppression systems and equipment will be inspected and cleaned **monthly** by a designated contractor under the supervision of the Operations Manager or Master Grower.

## **X. Employee Training**

Training for employees about the FPP will be provided:

- New Hire Orientation and onboarding
- At the time of initial work assignment
- Whenever new fire hazards are introduced into a work area
- Whenever employees are transferred to a new work area

Training topics will include:

- The fire hazards of the materials and processes to which employees are exposed
- Procedures for controlling the accumulations of flammable and combustible materials, including material handling and storage
- Applicable elements of the hazard communication program
- Emergency Evacuation Plan & Meeting Site

## **XI. Fire Evacuation**

Training for fire evacuation will be conducted on a quarterly basis. Employees, visitors, customers and anyone on the company premises will be required to leave the facility in the event of a fire, earthquake or any other emergency situation. They will be required to use the fire exits that are labeled with red exit signs, and to use stairs and not the elevator (if one is in building).

Employees, visitors, customers and anyone on the premises will be required to meet at the designated meeting area outside of the facility. Everyone must leave all purses and personal effects behind and must evacuate as soon as the alarm sounds. Employees are prohibited from leaving the meeting site until they have been accounted for and with the permission of management. Employees are not allowed into the facility without approval from the fire department.



## **XII. Recordkeeping**

A record of FPP training for employees will be maintained at the Louie's Gouie's facility with sign off forms indicating each employee's participation in the program. A Draft Safety Policy and Procedure Manual is attached and will be further developed along with the other administrative tools as we approach the state licensing phase.



**LOUIE'S GOUIE'S  
VEHICLE & DRIVERS SAFETY POLICY**





## Policy

It is the policy of Louie's Gouie's that our vehicles (including vans and light-duty trucks) will be used only for company business and will be operated only by authorized persons who meet the driver criteria in our vehicle safety program.

The purpose of this Policy is to ensure the safety of employees who drive company vehicles. Vehicle accidents are costly to our company, but more importantly, they may result in injury to you or others. It is the driver's responsibility to operate all vehicles in a safe manner and to drive defensively to prevent injuries and property damage. As such the Louie's Gouie's endorses all applicable state motor vehicle regulations relating to driver responsibility. Louie's Gouie's expects each driver to drive in a safe and courteous manner pursuant to the following safety rules. The attitude you take when behind the wheel is the single most important factor in driving safely.

## Driver Eligibility

Every delivery driver shall meet the following requirements:

- a) Drivers must be at least 21 years of age.
- b) Drivers must provide proof of automobile insurance at the time of hire and every six (6) months thereafter.
- c) Drivers must have a satisfactory driving record.
- d) Drivers are required to complete a Delivery Driver Application and receive a Delivery Driver badge (in addition to an Employment Application and completing a background investigation, if one is not already on file.
- e) Been issued an ID Badge by the Chief of Police indicating they are an approved delivery driver.
- f) A delivery driver shall only conduct deliveries on behalf of one registered collective during their shift.
- g) Hold a valid unexpired California Driver's License appropriate for the class of vehicle he or she will be driving.
- h) Have completed a background investigation by the Chief of Police that includes a driver's license review.
- i) Have in their possession during deliveries:
  1. California driver's license.
  2. Police department issued ID Badge indicating that they are an approved delivery driver.
  3. Vehicle's registration and proof of required insurance.
  4. Copy of the collective's Notice of Completed Registration.
  5. Present those documents to any Peace Officer or City official enforcing this code upon request.
  6. The delivery driver shall at all times during deliveries carry an operating cell phone to connect with the collective or emergency services as needed.
- j) Be a member of the registered collective.



## **Driver Policies and Procedures**

- Company vehicles are to be driven by authorized employees ONLY, except in emergencies, or in case of repair testing by a mechanic. Other employees and family members are not authorized to drive the Company vehicle.
- Company vehicles are to be driven for Company Business ONLY. Personal use of company vehicles is prohibited. No unauthorized persons are allowed to ride in company vehicles.
- Any employee who has his or her driver's license revoked or suspended shall immediately notify their Manager or Supervisor and discontinue operation of the company vehicle. Failure to do so may result in disciplinary action up to and including termination of employment.
- All accidents involving Company vehicles, regardless of severity, must be immediately reported to the police and to the driver's Manager and Licensee. Failing to stop after an accident and/or failure to report an accident may result in disciplinary action and up to and including termination of employment.
- The use of a company vehicle while under the influence of alcohol, intoxicants and other drugs is forbidden and is sufficient cause for discipline up to and including termination of employment.
- All drivers and authorized passengers while operating or riding in company vehicles must wear seat belts.
- Report any mechanical difficulties or repair needs immediately to dispatch and the driver's manager or supervisor.
- Drivers are responsible for the security of Company vehicles being used by them. The vehicle engine must be shut off, ignition keys removed, and vehicle doors locked whenever the vehicle is left unattended.

## **Driving Records**

Your personal driving record is a reflection of your overall driving habits, and directly affects our insurance costs. Your personal driving is your responsibility and our concern.

Motor Vehicle Records will be ordered every 6 months or as needed to assess driving records. An unfavorable record will result in the loss of company vehicle driving privileges.

## **Cell phone Usage**

- Under all circumstances, employees shall obey all motor vehicle laws. Violations or fines incurred by employees shall be the full responsibility of the employee and may



affect future driving privileges with Louie's Gouie's.

- California and Louie's Gouie's prohibits the use of a cell phone while driving. Texting is forbidden. Dialing out should be done only from a safely parked position.



- Hands-free cellular phones are subject to the same policy as the hand-held cellular phones. (No dialing out, texting, or interfering with safe operation of the vehicle).



## EMPLOYEE AUTHORIZATION FOR MVR REVIEW

I acknowledge that the information contained in the Louie's Gouie's's Driver Safety Policy has been reviewed with me, and a copy of the policy and driver rules have been furnished to me. As a driver of a company vehicle, I understand that it is my responsibility to operate the vehicle in a safe manner and to drive defensively to prevent injuries and property damage.

I also understand that my employer will periodically review my Motor Vehicle Record to determine continued eligibility to drive a company vehicle. In accordance with the Fair Credit Reporting Act, I have been informed that a Motor Vehicle Record will be periodically obtained on me for continued employment purposes.

I acknowledge the receipt of the above disclosure and authorize my employer or its designated agent to obtain a Motor Vehicle Record report. This authorization is valid as long as I am an employee or employee candidate and may only be rescinded in writing.

EMPLOYEE'S NAME (PRINT) \_\_\_\_\_ DATE \_\_\_\_\_

DRIVER'S LICENSE NUMBER \_\_\_\_\_ EXPIRATION DATE \_\_\_\_\_

EMPLOYEE SIGNATURE \_\_\_\_\_ DATE \_\_\_\_\_

REVIEWER'S SIGNATURE \_\_\_\_\_ DATE \_\_\_\_\_

REVIEWER'S NAME (PRINT) \_\_\_\_\_



# Delivery Driver Requirements

- Must have a valid Driver's License
- Must be at least 21 years of age in accordance with Federal Labor Laws
- Must have at least 2 years of U.S. Driving Experience
- NEW DMW/MVR report every 6 months
- Drivers must maintain insurance at all times on their vehicles
- Each vehicle operated during the course of business must have a completed Nine Point Strategies Vehicle Inspection form. Each completed form is reviewed by the carriers for acceptability. **(Substitution vehicles are not permitted without proper evidence of insurance on the auto and the vehicle inspection form is completed.)**
- Drivers may qualify with up to 2 Minor Violations within the last 36 months
- Drivers may qualify with 1 At-Fault Accident and 1 Minor Violation within the last 36 months
- No Major Violations in the past 5 years. Major Violation include, but not limited to:
  - Driving under the influence of drugs or alcohol
  - Reckless Driving
  - Hit & Run
  - Speed Contest
  - Driving with suspended/revoked license
  - Eluding a police officer
- **CA Only: Distracted Driving (i.e. Cell Phone Use, or texting violations. Any distracted driving violation cited after 10/01/2012 will now be counted as a Major Violation.**



## Prohibited Mobile Device

The drivers are prohibited from using their mobile device while driving in both the drivers requirements and the employment agreement. If they ever violate the rule, they will immediately be fired!

## Steps for checking Medical Marijuana 1st time patient:

1. After receiving a call from a first time patient we require them to send us a copy of both their license and medical prescription by Text, Email, or Verification through our site online.
2. Once we receive the copies for our files, we make sure both forms are identical in name and picture.
3. Then we verify their prescription by phone or online depending Louie's Gouie's. We always try online first since it's faster.

### Online:

1. With 420evaluation.com, I enter the patients # and DOB.
  2. It will say expired or not a current patient, if not verified.
  3. If it is current, it will give you the patients full name and the date of their expiration.
  4. I then make sure the full name is identical.
4. Once they are verified we call them back and are able to take their order. We place their information into our database that will notify use when their prescription expires. Otherwise they are good to order until their expiration date.
5. We check both the California ID and Prescription at the door before completing the transaction. This is done on every transaction to be sure the right person receives their prescription.

## **Steps for checking Medical Marijuana 1st time patient:**

## **Steps for checking Recreation Marijuana 1st time patient:**

1. After receiving a call from a first time patient we require them to send us a copy of their license by Text or Email.
2. Once we receive the copy we make sure they are over 21 and have a valid State ID.
3. We store it in our files and check it at the door before completing the transaction. We check everytime we deliver to make sure the right person is receiving the product.



## **EMPLOYEE HANDBOOK**

### **LOUIE'S GOUIES**







## Table of Contents

<u>General Employment Policies</u> .....	6
Introductory Statement.....	7
Harassment Discrimination and Retaliation Prevention .....	8
Confirmation of Harassment Discrimination and Retaliation Prevention Policy .....	12
At-Will Employment Status.....	13
Right to Revise .....	14
<u>Hiring</u> .....	15
Full-Time Employees .....	<b>Error! Bookmark not defined.</b>
Inactive Status.....	17
Job Duties.....	17
New Hires .....	17
Part-Time Employees.....	16
Regular Employees.....	16
Temporary Employees .....	16
<u>Leaves of Absence</u> .....	18
Bereavement Leave .....	19
Domestic Violence, Sexual Assault or Stalking Leave and Accommodation .....	19
Extended Medical Leave.....	20
Jury Duty and Witness Leave .....	20
Military Leave .....	21
Pregnancy Disability Leave Five or More Employees.....	21
School Appearances Involving Suspension .....	23
Sick Leave.....	23
Time Off for Voting .....	24
Vacation.....	25
Victims of Crime Leave .....	25



Volunteer Civil Service Personnel .....	26
<u>Benefits</u> .....	27
Benefits Overview .....	28
Holidays .....	28
Lactation Policy .....	28
Paid Family Leave .....	29
Workers' Compensation .....	29
<u>Management</u> .....	31
Employee Property .....	32
Employment of Relatives .....	32
Names and Addresses Policy .....	32
Open-Door Policy .....	32
Performance Evaluations .....	33
Personnel Records .....	33
Telecommuting .....	<b>Error! Bookmark not defined.</b>
Workplace Privacy - Audio/Video Recordings .....	34
<u>Company Property</u> .....	35
Bulletin Boards .....	36
Electronic and Social Media .....	36
Employer Property .....	39
Prohibiting Personal Use of Company Cell Phone .....	40
Smoking .....	40
Solicitation and Distribution of Literature .....	40
<u>Employee Conduct</u> .....	41
Conducting Personal Business .....	42
Confidential Information .....	42
Conflicts of Interest .....	42



Customer Relations.....	43
Dress Codes and Other Personal Standards .....	43
Drug and Alcohol Abuse .....	44
News Media Contacts .....	45
Off-Duty Conduct.....	45
Other Employment .....	45
Political Activity.....	45
Prohibited Conduct.....	46
Prohibited Use of Company Cell Phone While Driving.....	47
Punctuality and Attendance .....	47
<u>Wages</u> .....	49
Advances .....	<b>Error! Bookmark not defined.</b>
Deductions for Exempt Employees.....	50
Expense Accounts .....	50
Meal and Rest Periods.....	51
Overtime for Nonexempt Employees.....	53
Payment of Wages .....	53
Recruitment Bonus.....	54
Timekeeping Requirements .....	54
<u>Safety and Health</u> .....	55
Employees Who Are Required to Drive .....	56
Ergonomics.....	56
Fragrance Policy .....	56
Health and Safety.....	56
Recreational Activities and Programs.....	57
Security.....	57
Workplace Violence .....	57
<u>Termination</u> .....	59



Employee References.....60

Involuntary Termination and Progressive Discipline .....60

Reductions in Force .....60

Voluntary Resignation .....60

Confirmation of Receipt .....61

Confirmation of Receipt.....62



## **General Employment Policies**



## Introductory Statement

Welcome! As an employee of Organic Care (the "Company"), you are an important member of a team effort. We hope that you will find your position with the Company rewarding, challenging, and productive.

Because our success depends upon the dedication of our employees, we are highly selective in choosing new members of our team. We look to you and the other employees to contribute to the success of the Company.

This employee handbook is intended to explain the terms and conditions of employment of all full- and part-time employees. Written employment contracts between Organic Care and some individuals may supersede some of the provisions of this handbook.

This handbook summarizes the policies and practices in effect at the time of publication. This handbook supersedes all previously issued handbooks and any policy or benefit statements or memoranda that are inconsistent with the policies described here. Your supervisor or manager will be happy to answer any questions you may have.



## Harassment Discrimination and Retaliation Prevention

Organic Care (“the Company”) is an equal opportunity employer. Organic Care is committed to providing a work environment free of harassment, discrimination, retaliation, and disrespectful or other unprofessional conduct based on sex (including pregnancy, childbirth, breastfeeding or related medical conditions), sex stereotype, race, religion (including religious dress and grooming practices), color, gender (including gender identity, gender expression and transgender), national origin (including language use restrictions and possession of a driver's license issued under Vehicle Code section 12801.9), ancestry, physical or mental disability, medical condition, genetic information, marital status, registered domestic partner status, age, sexual orientation, military and veteran status or any other basis protected by federal, state or local law or ordinance or regulation. It also prohibits discrimination, harassment, disrespectful or unprofessional conduct based on the perception that anyone has any of those characteristics or is associated with a person who has or is perceived as having any of those characteristics.

In addition, the Company prohibits retaliation against individuals who raise complaints of discrimination or harassment or who participate in workplace investigations.

**All such conduct violates Company policy.**

### Harassment Prevention

The Company's policy prohibiting harassment applies to all persons involved in the operation of the Company. The Company prohibits harassment, disrespectful or unprofessional conduct by any employee of the Company, including supervisors, managers and co-workers. The Company's anti-harassment policy also applies to vendors, customers, independent contractors, unpaid interns, volunteers, persons providing services pursuant to a contract and other persons with whom you come into contact while working.

Prohibited harassment, disrespectful or unprofessional conduct includes, but is not limited to, the following behavior:

- Verbal conduct such as epithets, derogatory jokes or comments, slurs or unwanted sexual advances, invitations, comments, posts or messages;
- Visual displays such as derogatory and/or sexually-oriented posters, photography, cartoons, drawings or gestures;
- Physical conduct including assault, unwanted touching, intentionally blocking normal movement or interfering with work because of sex, race or any other protected basis;
- Threats and demands to submit to sexual requests or sexual advances as a condition of continued employment, or to avoid some other loss and offers of employment benefits in return for sexual favors;
- Retaliation for reporting or threatening to report harassment; and
- Communication via electronic media of any type that includes any conduct that is prohibited by state and/or federal law or by company policy.





Sexual harassment does not need to be motivated by sexual desire to be unlawful or to violate this policy. For example, hostile acts toward an employee because of his/her gender can amount to sexual harassment, regardless of whether the treatment is motivated by sexual desire.

Prohibited harassment is not just sexual harassment but harassment based on any protected category.

### **Non-Discrimination**

The Company is committed to compliance with all applicable laws providing equal employment opportunities. This commitment applies to all persons involved in Company operations. The Company prohibits unlawful discrimination against any job applicant, employee or unpaid intern by any employee of the Company, including supervisors and coworkers.

Pay discrimination between employees of the opposite sex or between employees of another race or ethnicity performing substantially similar work, as defined by the California Fair Pay Act and federal law, is prohibited. Pay differentials may be valid in certain situations defined by law. Employees will not be retaliated against for inquiring about or discussing wages. However, Organic Care is not obligated to disclose the wages of other employees.

### **Anti-Retaliation**

The Company will not retaliate against you for filing a complaint or participating in any workplace investigation or complaint process, and will not tolerate or permit retaliation by management, employees or co-workers.

### **Reasonable Accommodation**

Discrimination can also include failing to reasonably accommodate religious practices or qualified individuals with disabilities where the accommodation does not pose an undue hardship.

To comply with applicable laws ensuring equal employment opportunities to qualified individuals with a disability, the Company will make reasonable accommodations for the known physical or mental limitations of an otherwise qualified individual with a disability who is an applicant or an employee unless undue hardship would result.

Any job applicant or employee who requires an accommodation in order to perform the essential functions of the job should contact a Company representative with day-to-day personnel responsibilities and discuss the need for an accommodation. The Company will engage in an interactive process with the employee to identify possible accommodations, if any, that will help the applicant or employee perform the job. An applicant, employee or unpaid intern who requires an accommodation of a religious belief or practice (including religious dress and grooming practices, such as religious clothing or hairstyles) should also contact a Company representative with day-to-day personnel responsibilities and discuss the need for an



accommodation. If the accommodation is reasonable and will not impose an undue hardship, the Company will make the accommodation.



The Company will not retaliate against you for requesting a reasonable accommodation and will not knowingly tolerate or permit retaliation by management, employees or co-workers.

### **Complaint Process**

If you believe that you have been the subject of harassment, discrimination, retaliation or other prohibited conduct, bring your complaint to your supervisor or to:

- Any other Company supervisor or Manager
- The office manager or owner(s) of Organic Care
- The president
- Another designated Company representative

as soon as possible after the incident. You can bring your complaint to any of these individuals. If you need assistance with your complaint, or if you prefer to make a complaint in person, contact one of the individuals listed above. Please provide all known details of the incident or incidents, names of individuals involved and names of any witnesses. It would be best to communicate your complaint in writing, but this is not mandatory.

The Company encourages all individuals to report any incidents of harassment, discrimination, retaliation or other prohibited conduct forbidden by this policy immediately so that complaints can be quickly and fairly resolved.

You also should be aware that the Federal Equal Employment Opportunity Commission and the California Department of Fair Employment and Housing investigate and prosecute complaints of prohibited harassment, discrimination and retaliation in employment. If you think you have been harassed or discriminated against or that you have been retaliated against for resisting, complaining or participating in an investigation, you may file a complaint with the appropriate agency. The nearest office can be found by visiting the agency websites at [www.dfeh.ca.gov](http://www.dfeh.ca.gov) and [www.eeoc.gov](http://www.eeoc.gov).

Supervisors or Managers must refer all complaints involving harassment, discrimination, retaliation or other prohibited conduct to the owner(s) or President of the Company so the Company can try to resolve the complaint.

When the Company receives allegations of misconduct, it will immediately undertake a fair, timely, thorough and objective investigation of the allegations in accordance with all legal requirements. The Company will reach reasonable conclusions based on the evidence collected.

The Company will maintain confidentiality to the extent possible. However, the Company cannot promise complete confidentiality. The employer's duty to investigate and take corrective action may require the disclosure of information to individuals with a need to know.

Complaints will be:

- Responded to in a timely manner



- Kept confidential to the extent possible



- Investigated impartially by qualified personnel in a timely manner
- Documented and tracked for reasonable progress
- Given appropriate options for remedial action and resolution
- Closed in a timely manner

If the Company determines that harassment, discrimination, retaliation or other prohibited conduct has occurred; appropriate and effective corrective and remedial action will be taken in accordance with the circumstances involved. The Company also will take appropriate action to deter future misconduct.

Any employee determined by the Company to be responsible for harassment, discrimination, retaliation or other prohibited conduct will be subject to appropriate disciplinary action, up to, and including termination. Employees should also know that if they engage in unlawful harassment, they can be held personally liable for the misconduct.



## Confirmation of Harassment Discrimination and Retaliation Prevention Policy

I have received my copy of the ORGANIC CARE ("the Company") Harassment, Discrimination and Retaliation Prevention policy. I understand and agree that it is my responsibility to read and familiarize myself with this policy.

I understand that the Company is committed to providing a work environment that is free from harassment, discrimination and retaliation. My signature certifies that I understand that I must conform to and abide by the rules and requirements described in this policy.

Employee's Signature \_\_\_\_\_

Employee's Printed Name \_\_\_\_\_

Date \_\_\_\_\_



## At-Will Employment Status

Organic Care personnel are employed on an at-will basis. Employment at-will means that the employment relationship may be terminated, with or without cause and with or without advance notice at any time by the employee or the Company. Nothing in this handbook shall limit the right to terminate at-will employment.

No manager, supervisor, or employee of the Company has any authority to enter into an agreement for employment for any specified period of time or to make an agreement for employment on other than at-will terms. Only the owner(s) or President of Organic Care has the authority to make any such agreement, which is binding only if it is in writing.

Nothing in this at-will statement is intended to interfere with an employee's rights to communicate or work with others toward altering the terms and conditions of his or her employment.





## Right to Revise

This employee handbook contains the employment policies and practices of Organic Care in effect at the time of publication. All previously issued handbooks and any inconsistent policy statements or memoranda are superseded.

Organic Care reserves the right to revise, modify, delete, or add to any and all policies, procedures, work rules, or benefits stated in this handbook or in any other document, except for the policy of at-will employment. However, any such changes must be in writing and must be signed by the owner(s) or the President of ORGANIC CARE.

Any written changes to this handbook will be distributed to all employees so that employees will be aware of the new policies or procedures. No oral statements or representations can in any way alter the provisions of this handbook.

This handbook sets forth the entire agreement between you and Organic Care as to the duration of employment and the circumstances under which employment may be terminated. Nothing in this employee handbook or in any other personnel document, including benefit plan descriptions, creates or is intended to create a promise or representation of continued employment for any employee.

Nothing in this at-will statement is intended to interfere with an employee's rights to communicate or work with others toward altering the terms and conditions of his or her employment.



## **Hiring**



## Regular Employees

Regular employees are those who are hired to work on a regular schedule. Regular employees may be classified as full-time or part-time.

## Part-Time Employees

Part-time employees are those who are scheduled for and do work fewer than 30 hours per week, but not fewer than 20 hours. Part-time employees are eligible for the following Organic Care benefits:

- Sick leave

## Temporary or Seasonal Employees

Temporary or Seasonal employees are those employed for short-term assignments. Short-term assignments generally are periods of three months or fewer; however, such assignments may be extended. Temporary or Seasonal employees are not eligible for employee benefits except those mandated by applicable law.



## Inactive Status

Employees who are on any type of leave of absence, work-related or non-work-related, that exceeds any protected state or federal leave of absence will be placed on inactive status.

### Health Benefits Extension

Unless health benefits extension is covered by state or federal law, benefits will terminate according to our insurance carrier's policy. Contact your supervisor or manager for more information.

## Job Duties

During the introductory period, your supervisor will explain your job responsibilities and the performance standards expected of you. Be aware that your job responsibilities may change at any time during your employment. From time to time, you may be asked to work on special projects, or to assist with other work necessary or important to the operation of your department or Organic Care. Your cooperation and assistance in performing such additional work is expected.

Organic Care reserves the right, at any time, with or without notice, to alter or change job responsibilities, reassign or transfer job positions, or assign additional job responsibilities.

## New Hires

Completion of the introductory period does not entitle you to remain employed by Organic Care for any definite period of time. Your status as an at-will employee does not change. The employment relationship may be terminated with or without cause and with or without advance notice, at any time by you or the Company.

The first 90 days of continuous employment at Organic Care is considered an introductory period. During this time, you will learn your responsibilities, get acquainted with fellow employees and determine whether or not you are happy with your job. Your supervisor will closely monitor your performance.



## **Leaves of Absence**



## **Bereavement Leave**

Organic Care grants leave of absence to employees in the event of the death of the employee's current spouse, registered domestic partner, child, parent, legal guardian, brother, sister, grandparent, or grandchild; or mother-, father-, sister-, brother-, son-, or daughter-in-law. An employee with such a death in the family may take up to 3 days consecutive scheduled workdays off without pay with the approval of the Company. The employee's supervisor may approve additional unpaid time off.

## **Domestic Violence, Sexual Assault or Stalking Leave and Accommodation**

Employees who are victims of domestic violence, sexual assault and stalking are eligible for unpaid leave. Although the leave is generally unpaid, employees can use their paid sick time under California's Healthy Workplaces, Healthy Families Act for the purposes described below.

You may request leave if you are involved in a judicial action, such as obtaining restraining orders, or appearing in court to obtain relief to ensure your health, safety or welfare, or that of your child. Please provide reasonable advance notice of the need for leave unless advance notice is not feasible. Contact your manager or supervisor.

Employees who are victims of domestic violence, sexual assault or stalking and need a reasonable accommodation for their safety at work should contact a manager or Company representative with day-to-day personnel responsibilities and discuss the need for an accommodation. If you are requesting such a reasonable accommodation, you will need to submit a written statement signed by you, or by an individual acting on your behalf, certifying that the accommodation is for the purpose of your safety at work.

For reasonable accommodation requests, the Company will also require certification demonstrating that you are the victim of domestic violence, sexual assault or stalking. Any of the forms of certification described above for leave purposes will suffice. The Company may request recertification every six months from the date of the previous certification. You should notify the company if an approved accommodation is no longer needed.

The Company will engage in an interactive process with the employee to identify possible accommodations, if any, that are effective and will make reasonable accommodations unless an undue hardship will result.

Organic Care will, to the extent allowed by law, maintain the confidentiality of an employee requesting leave or accommodation under these provisions.



## Extended Medical Leave

A medical leave of absence may be granted for non-work-related medical disabilities (other than pregnancy, childbirth, and related medical conditions) with a doctor's written certificate of disability. Extended disability leaves will also be considered on a case-by-case basis, consistent with the Company's obligations under federal and state disability laws.

Employees should request any leave in writing as far in advance as possible. If you are granted a medical leave, Organic Care will pay you sick pay for the period of time equivalent to your accumulated sick pay earned.

A medical leave begins on the first day your doctor certifies that you are unable to work and ends when your doctor certifies that you are able to return to work. Your supervisor or manager will supply you with a form for your doctor to complete, showing the date you were disabled and the estimated date you will be able to return to work. An employee returning from a medical disability leave must present a doctor's certificate declaring fitness to return to work.

If returning from a non-work-related medical leave, you will be offered the same position you held at the time your leave began, if available. If your former position is not available, a comparable position will be offered. If neither the same nor a comparable position is available, your return to work will depend on job openings existing at the time of your scheduled return. Organic Care makes no guarantees of reinstatement, and your return will depend on your qualifications for existing openings.

California workers' compensation laws govern work-related injuries and illnesses. California pregnancy disability laws govern leaves taken because of pregnancy, childbirth, and related medical conditions. An employee that needs reasonable accommodations should contact a company representative with day-to-day personnel responsibilities and discuss the need for an accommodation.

## Jury Duty and Witness Leave

Organic Care encourages employees to serve on jury duty when called. Organic Care does not offer jury duty pay at this time. You should notify your supervisor of the need for time off for jury duty as soon as a notice or summons from the court is received. You may be requested to provide written verification from the court clerk of performance of jury service. If work time remains after any day of jury selection or jury duty, you will be expected to return to work for the remainder of your work schedule.

### Fees Paid by the Court

You may retain any mileage allowance or other fee paid by the court for jury services.



## Military Leave

Employees who wish to serve in the military and take military leave should contact their manager or supervisor for information about their rights before and after such leave. You are entitled to reinstatement upon completion of military service, provided you return or apply for reinstatement within the time allowed by law.

## Pregnancy Disability Leave Five or More Employees

If you are pregnant, have a related medical condition, or are recovering from childbirth, please review this policy. Any employee planning to take pregnancy disability leave should advise the personnel department as early as possible. The individual should make an appointment with their manager or supervisor to discuss the following conditions:

- Duration of pregnancy disability leave will be determined by the advice of the employee's physician, but employees disabled by pregnancy may take up to four months of unpaid leave per pregnancy (the working days you normally would work in one-third of a year or 17 1/3 weeks). Part-time employees are entitled to leave on a pro rata basis. The four months of leave includes any period of time for actual disability caused by the employee's pregnancy, childbirth, or related medical condition. This includes leave for severe morning sickness and for prenatal care, doctor-ordered bed rest, as well as other reasons. Your healthcare provider determines how much time you need for your disability.
- Organic Care will also reasonably accommodate medical needs related to pregnancy, childbirth, or related conditions or temporarily transfer you to a less strenuous or hazardous position (where one is available) or duties if medically needed because of your pregnancy.
- Employees who need to take pregnancy disability must inform Organic Care when a leave is expected to begin and how long it will likely last. If the need for a leave, reasonable accommodation, or transfer is foreseeable (such as the expected birth of a child or a planned medical treatment for yourself), employees must provide at least 30 days advance notice before the pregnancy disability leave or transfer is to begin. Employees must consult with their manager regarding the scheduling of any planned medical treatment or supervision in order to minimize disruption to the operations of the Company. Any such scheduling is subject to the approval of the employee's health care provider;
- For emergencies or events that are unforeseeable, we need you to notify the Company, at least verbally, as soon as practical after you learn of the need for the leave.
- Failure to comply with these notice requirements may result in delay of leave, reasonable accommodation, or transfer;
- Pregnancy leave usually begins when ordered by the employee's physician. The employee must provide Organic Care with a written certification from a health care provider for need of PDL, reasonable accommodation or transfer. The certification must be returned no later than 15 calendar days after it is requested by the Company. Failure to do so may, in some circumstances, delay PDL leave, reasonable accommodation or transfer. Please see the personnel department for a medical certification form to give to your health provider.



- Leave returns will be allowed only when the employee's physician sends a release;



- An employee will be allowed to use accrued sick time (if otherwise eligible to take the time) during a pregnancy disability leave.
- Leave does not need to be taken in one continuous period of time and may be taken intermittently, as needed. Leave may be taken in increments of 4 hours.

If intermittent leave or leave on a reduced work schedule is medically advisable the employee may, in some instances, be required to transfer temporarily to an available alternative position that meets the employee's needs. The alternative position need not consist of equivalent duties, but must have the equivalent rate of pay and benefits. The employee must be qualified for the position. The position must better accommodate the employee's leave requirements than her regular job. Transfer to an alternative position can include altering an existing job to better accommodate the employee's need for intermittent leave or a reduced work schedule.

Upon submission of a medical certification that an employee is able to return to work from a pregnancy disability leave, an employee will be reinstated to her same position held at the time the leave began or, in certain instances, to a comparable position, if available. There are limited exceptions to this policy. An employee returning from a pregnancy disability leave has no greater right to reinstatement than if the employee had been continuously employed.

Employees on pregnancy disability leave will be allowed to continue to participate in group health insurance coverage for up to a maximum of four months of disability leave (if such insurance was provided before the leave was taken) at the level and under the conditions that coverage would have been provided if the employee had continued in employment continuously for the duration of the leave. In some instances, an employer can recover from an employee premiums paid to maintain health coverage if the employee fails to return following pregnancy disability leave. PDL may impact other benefits or a seniority date. Please contact your manager or supervisor for more information.



## School Appearances Involving Suspension

If an employee who is the parent or guardian of a child facing suspension from school is summoned to the school to discuss the matter, the employee should alert his or her supervisor as soon as possible before leaving work. In agreement with California Labor Code Section 230.7, no discriminatory action will be taken against an employee who takes time off for this purpose.

## Sick Leave

California law provides for mandatory paid sick leave under the Healthy Workplaces, Healthy Families Act (the "Act"). This paid sick leave policy is intended to comply with the requirements of the Act.

Employees cannot be discriminated or retaliated against for requesting or using accrued paid sick time.

If you have any questions about paid sick leave, please contact your manager or supervisor .

### Eligible Employees

Beginning July 1, 2015, all employees who have worked in California for the same employer for 30 or more days within a year from the start of their employment will be entitled to paid sick time.

**However, employees are not eligible to take paid sick time until they have worked for the Company for 90 days from their date of hire.**

### Sick Pay Amount

Eligible employees will receive sick leave as follows:

#### Employees hired after July 1, 2015:

Organic Care will provide eligible employees with three days or 24 hours of paid sick time on their first day of employment with Organic Care. You will need to meet the 90 day employment requirement before taking any leave.

*Unused paid sick time will not carry over from year to year.* However, Organic Care will place three days or 24 hours of paid sick time into your leave bank each year on your anniversary date. Employees will be able to access all three days or 24 hours of paid sick time at the beginning of each 12-month period.

The Company does not pay employees for unused paid sick time at the time of termination.



## **Qualifying Reasons for Paid Sick Leave**

Paid sick time can be used for the following reasons:

- Diagnosis, care or treatment of an existing health condition for an employee or covered family member, as defined below.
- Preventive care for an employee or an employee's covered family member.
- For certain, specified purposes when the employee is a victim of domestic violence, sexual assault or stalking.

For purposes of paid sick leave, a covered family member includes:

- A child defined as a biological, foster or adopted child; a stepchild; or a legal ward, regardless of the age or dependency status of the child. A "child" also may be someone for whom you have accepted the duties and responsibilities of raising, even if he or she is not your legal child.
- A "parent" defined as a biological, foster or adoptive parent; a stepparent; or a legal guardian of an employee or the employee's spouse or registered domestic partner. A parent may also be someone who accepted the duties and responsibilities of raising you when you were a minor child, even if he or she is not your legal parent.
- A spouse.
- A registered domestic partner.
- A grandparent.
- A grandchild.
- A sibling.

## **Use of Paid Sick Leave**

If the need for paid sick leave is foreseeable, employees shall provide advance oral or written notification to the supervisor or manager. If the need for paid sick leave is not foreseeable, employees shall provide notice to the supervisor or manager as soon as practicable.

An employee's use of paid sick time may run concurrently with other leaves under local, state or federal law.

Paid sick leave can be used in four (4) hours hour increments.

## **Time Off for Voting**

If an employee does not have sufficient time outside of working hours to vote in an official state-sanctioned election, the employee may take off enough working time to vote. Such time off shall be taken at the beginning or the end of the regular working shift, whichever allows for more free time, and the time taken off shall be combined with the voting time available outside of working hours to a maximum of two hours combined. Under these circumstances, an employee



will be allowed a maximum of two hours of time off during an election day without loss of pay.



When possible, an employee requesting time off to vote shall give his or her supervisor at least a two days notice.

## Vacation

### Vacation Accrual Introductory Period

Regular full-time employees may accrue paid vacations in accordance with the following policy:

Temporary and part-time employees do not accrue paid vacation time. Regular full-time employees do not accrue vacation time during the first six months of employment. No vacation time may be taken until after completion of the first year of employment.

After completion of the initial six months of continuous employment, full-time employees begin to accrue vacation time at the rate of 3.33 per month. An employee who is scheduled to and does work 40 hours per week will normally accrue five working days or 40 hours of vacation in the second six months of continuous employment.

The Company encourages employees to take vacation annually. Vacation time must be taken within the year following accrual. Earned vacation time accrues to a maximum of forty (40) hours..

No additional vacation will be earned until accrued vacation time is used. Employees are responsible for tracking their accrued vacation time.

An employee whose employment terminates will be paid for accrued unused vacation days on a pro rata basis. Vacations shall be scheduled to provide adequate coverage of job responsibilities and staffing requirements. The general manager or manager will make final determinations and must approve your vacation schedule in advance.

## Victims of Crime Leave

An employee who is themselves a victim or who is the family member of a victim of certain serious crimes may take time off from work to attend judicial proceedings related to the crime or to attend proceedings involving rights of the victim.

A family member of a crime victim may be eligible to take this leave if he/she is the crime victim's spouse, parent, child or sibling. Other family members may also be covered depending on the purpose of the leave.

The absence from work must be in order to attend judicial proceedings or proceedings involving rights of the victim. Only certain crimes are covered. You must provide reasonable advance notice of your need for leave, and documentation related to the proceeding may be required. If advance notice is not possible, you must provide appropriate documentation within a reasonable time after the absence.

Any absence from work to attend judicial proceedings or proceedings involving victim rights will be unpaid.





For more information regarding this leave (including whether you are covered, when and what



type of documentation is required, and which type of paid time off can be used), please contact your manager or supervisor with day-to-day personnel responsibilities.

### **Volunteer Civil Service Personnel**

No employee shall be disciplined for taking time off to perform emergency duty as a volunteer firefighter, peace officer, or emergency rescue personnel. Employees who perform emergency duty as a volunteer firefighter, reserve peace officer, or emergency rescue personnel may also take up to a total of fourteen days unpaid leave time per calendar year to engage in required fire, law enforcement or emergency rescue training. Please alert your supervisor that you may have to take time off for emergency duty or emergency duty training. When taking time off for emergency duty, please alert your supervisor before doing so when possible.



## **Benefits**



## Benefits Overview

Organic Care is committed to providing the following benefits for eligible employees. Benefit eligibility may be dependent upon your employee classification (full-time versus part-time, for example) and on length of continuous employment at ORGANIC CARE. Benefit eligibility requirements may also be imposed by the plans themselves.

Upon becoming eligible for certain employee benefit plans, you will receive a Summary Plan Descriptions which describe the benefits in greater detail. For information regarding employee benefits and to answer any questions you may have contact your manager or supervisor.

The Company reserves the right to modify, amend or terminate benefits and to modify or amend benefit eligibility requirements at any time and for any reason, subject to any legal restrictions.

The Company offers the following employee benefits:

- Health Insurance
- Dental Insurance

## Holidays

For the 2018 calendar year, Organic Care observes the following paid holidays:

- January 1 (New Year's Day)
- July 4th (Independence Day)
- Thanksgiving Day and the Friday after
- Christmas Eve
- Christmas Day

When a holiday falls on a Saturday or Sunday, it is usually observed on the preceding Friday or the following Monday. However, Organic Care may grant another day off in lieu of closing. Holiday observance will be announced in advance.

Each non-exempt employee's eligibility for holiday pay begins after completion of his or her introductory period. To be eligible for holiday pay, you must be regularly scheduled to work on the day on which the holiday is observed and must work your regularly scheduled working days immediately preceding and immediately following the holiday, unless an absence on either day is approved in advance by your supervisor or the absence is otherwise protected by law. If you are required to work on a paid scheduled holiday you will receive double time.

## Lactation Policy

Organic Care accommodates lactating employees by providing a reasonable amount of break time to any employee who desires to express breast milk for an infant child. The break time shall, if possible, run concurrently with any break time already provided to the employee. Any



break time provided to express breast milk that does not run concurrently with break time



already provided to the employee shall be unpaid. However, if providing such break time would seriously disrupt the operations of our business, we may deny break time to employees who wish to express breast milk.

We will make reasonable efforts to provide employees who need a lactation accommodation with the use of a room or other private location that is located close to the employee's work area. Employees with private offices will be required to use their offices to express breast milk.

Employees who desire lactation accommodations should contact their supervisor or Human Resources to request accommodations.

Discrimination on the basis of sex includes discrimination based on breastfeeding and related medical conditions and is unlawful.

## Paid Family Leave

Employees may be eligible for Paid Family Leave (PFL) wage replacement benefits, which are funded through payroll deductions and coordinated through the Employment Development Department. PFL provides limited compensation for up to six weeks after an unpaid, seven-day waiting period when an employee needs to take leave from work to care for a parent, parent-in-law, child, spouse, registered domestic partner, grandparent, grandchild, or sibling who is seriously ill, or for a working parent who wants time to bond with his or her newborn, foster child or newly adopted child. The PFL program does not provide employees with a right to a leave of absence; it is limited to a state-mandated wage replacement benefit.

## Workers' Compensation

Organic Care, in accordance with state law, provides insurance coverage for employees in case of work-related injury. The workers' compensation benefits provided to injured employees may include:

- Medical care;
- Cash benefits, tax free, to replace lost wages; and
- Assistance to help qualified injured employees return to suitable employment.

To ensure that you receive any workers' compensation benefits to which you may be entitled, you will need to:

- Immediately report any work-related injury to your supervisor;
- Seek medical treatment and follow-up care if required;
- Complete a written *Employee's Claim for Workers' Compensation Benefits* (DWC Form 1) and return it to your manager or supervisor; and
- Provide the Company with a certification from your health care provider regarding the need for workers' compensation disability leave, as well as your eventual ability to return to work from the leave.



Upon submission of a medical certification that an employee is able to return to work after a workers' compensation leave, the employee under most circumstances will be reinstated to his or her same position held at the time the leave began, or to an equivalent position, if available. An employee returning from a workers' compensation leave has no greater right to reinstatement than if the employee had been continuously employed rather than on leave. For example, if the employee on workers' compensation leave would have been laid off had he or she not gone on leave, or if the employee's position has been eliminated or filled in order to avoid undermining the Company's ability to operate safely and efficiently during the leave, and no equivalent or comparable positions are available, then the employee would not be entitled to reinstatement.

An employee's return depends on his or her qualifications for any existing openings. If, after returning from a workers' compensation disability leave, an employee is unable to perform the essential functions of his or her job because of a physical or mental disability, the Company's obligations to the employee may include reasonable accommodation, as governed by the Americans with Disabilities Act.

The law requires Organic Care to notify the workers' compensation insurance company of any concerns of false or fraudulent claims.

### **Company-Provided Physician**

Organic Care provides medical treatment for work-related injuries through a medical provider network, which the company has chosen to provide medical care to injured employees because of their experience in treating work-related injuries.





## **Management**



## Employee Property

An employee's personal property, including but not limited to lockers, packages, purses, and backpacks, may be inspected upon reasonable suspicion of unauthorized possession of Organic Care property, possession of dangerous weapons or firearms, or abuse of the Company's drug and alcohol policy.

## Employment of Relatives

Relatives of employees may be eligible for employment with Organic Care only if individuals involved do not work in a direct supervisory relationship, or in job positions in which there is a conflict of interest. The Company defines "relatives" as spouses, registered domestic partners, children, siblings, parents, in-laws, and step-relatives. Present employees who marry or become registered domestic partners will be permitted to continue working in the job position held only if they do not work in a direct supervisory relationship with one another or in job positions involving conflict of interest.

## Names and Addresses Policy

Organic Care is required by law to keep current all employees' names and addresses. Employees are responsible for notifying the Company in the event of a name or address change.

## Open-Door Policy

Suggestions for improving Organic Care are always welcome. At some time, you may have a complaint, suggestion, or question about your job, your working conditions, or the treatment you are receiving. Your complaints, questions, and suggestions also are of concern to the Company.

If you have a complaint, suggestion or question, speak with your immediate supervisors as soon as possible. If you are not comfortable speaking to your immediate supervisor, please bring the issue to any other member of management.

Moreover, if you have raised the issue and if the problem persists, you may present it to the owner(s) who will investigate and provide a solution or explanation.

If the problem is not resolved, you may also present the problem to the owner(s) or president of Organic Care, who will attempt to reach a final resolution.

While a written complaint will assist us in investigating your concerns, it is not required that you put your complaint in writing. If you need assistance with your complaint, or you prefer to make a complaint in person, contact a member of management.

This procedure, which we believe is important for both you and the Company, cannot guarantee that every problem will be resolved to your satisfaction. However, Organic Care values your observations and you should feel free to raise issues of concern without the fear of retaliation.



## Performance Evaluations

Each employee will receive periodic performance reviews conducted by his or her supervisor. Your first performance evaluation will take place six months after your date of hire. Subsequent performance evaluations will be conducted anniversary date. The frequency of performance evaluations may vary depending upon length of service, job position, past performance, changes in job duties, or recurring performance problems.

Your performance evaluations may review factors such as the quality and quantity of the work you perform, your knowledge of the job, your initiative, your work attitude, and your attitude toward others. The performance evaluations are intended to make you aware of your progress, areas for improvement, and objectives or goals for future work performance. Favorable performance evaluations do not guarantee increases in salary or promotions. Salary increases and promotions are solely within the discretion of Organic Care and depend upon many factors in addition to performance. After the review, you will be required to sign the evaluation report simply to acknowledge that it has been presented to you, that you have discussed it with your supervisor, and that you are aware of its contents.

## Personnel Records

You have a right to inspect or receive a copy of the personnel records that Organic Care maintains relating to your performance or to any grievance concerning you. Certain documents may be excluded or redacted from your personnel file by law, and there are legal limitations on the number of requests that can be made.

Any request to inspect or copy personnel records must be made in writing to your manager or supervisor. You can obtain a form for making such a written request from your manager or supervisor.

You may designate a representative to conduct the inspection of the records or receive a copy of the records. However, any designated representative must be authorized by you in writing to inspect or receive a copy of the records. Organic Care may take reasonable steps to verify the identity of any representative you have designated in writing to inspect or receive a copy of your personnel records.

The personnel records may be made available to you either at the place where you work or at a mutually agreeable location (with no loss of compensation for going to that location to inspect or copy the records). The records will be made available no later than 30 calendar days from the date Organic Care receives your written request to inspect or copy your personnel records (unless you/your representative and Organic Care mutually agree in writing to a date beyond 30 calendar days but no later than 35 calendar days from receipt of the written request).

If you request a copy of the contents of your file, you will be charged the actual cost of copying.

Disclosure of personnel information to outside sources, other than your designated representative, will be limited. However, Organic Care will cooperate with request from authorized law enforcement or local, state, or federal agencies conducting official investigations and as otherwise legally required.



## Workplace Privacy - Audio/Video Recordings

Due to concerns regarding the potential for invasion of privacy, sexual or other harassment, and protection of proprietary or confidential information, employees may not use any audio or video recording devices while on working time. Employees also may **not** use any audio or video recordings in work areas that Organic Care has identified as confidential, secure or private, unless the employee is engaged in protected activity related to improving the terms and conditions of his/her employment, such as documenting health and safety issues.



## **Company Property**



## Bulletin Boards

Organic Care maintains bulletin boards located offices.

Bulletin boards are used to provide information to employees concerning company related announcements.

Employees may not post items on Company bulletin boards unless the following conditions are met:

- Postings may be made by Company employees only;
- The information to be posted must first be approved by your manager or supervisor.
- Postings are limited to 8.5" x 11" in size;
- Bulletin boards will be updated monthly; and
- Posted items will be dated and will be removed after one month.

## Electronic and Social Media

This policy is intended to protect the Company's computer systems and electronic information.

For purposes of these policies, the following definitions apply: "Computers" are defined as desktop computers, laptops, handheld devices (including but not limited to iPhones, Black berries, smart phones, iPads, and other electronic tablets and cell phones), computer software/hardware and servers, and .

Organic Care also uses various forms of "electronic communication." "Electronic communications" includes e-mail, text messages, telephones, cell phones and other handheld devices (such as cell phones, Blackberries or smart phones or writing tablets or iPads), fax machines, and online services including the Internet.

"Electronic information" is any information created by an employee using computers or any means of electronic communication, including but not limited to, data, messages, multimedia data, and files.

The following general policies apply:

- Computers and all data transmitted through Organic Care servers are Company property owned by the Company for the purpose of conducting Company business. These items must be maintained according to Organic Care rules and regulations. Computers must be kept clean and employees must exercise care to prevent loss and damage. Prior authorization must be obtained before any Company property may be removed from the premises.
- All electronic communications also remain the sole property of Organic Care and are to be used for Company business. For example, email messages are considered Company records.



- Electronic information created by an employee using any computer or any means of





electronic communication is also the property of Organic Care and remains the property of Organic Care.

- Information stored in Organic Care computers and file servers, including without limitation Customer lists, vendor lists, research data, company proprietary information is the property of the Company and may not be distributed outside the Company in any form whatsoever without the written permission of the owner(s) or President.
- Violation of any of the provisions of this policy, whether intentional or not, will subject Organic Care employees to disciplinary action, up to and including termination.

### **Monitoring of Company Property**

Organic Care reserves the right to inspect all Company property to ensure compliance with its rules and regulations, without notice to the employee and at any time, not necessarily in the employee's presence. Organic Care computers and all electronic communications and electronic information are subject to monitoring and no one should expect privacy regarding such use. The Company reserves the right to access, review and monitor electronic files, information, messages, text messages, e-mail, Internet history, browser-based webmail systems and other digital archives and to access, review and monitor the use of computers, software, and electronic communications to ensure that no misuse or violation of Company policy or any law occurs. E-mail may be monitored by the Company and there is no expectation of privacy. Assume that e-mail may be accessed, forwarded, read or heard by someone other than the intended recipient, even if marked as "private."

Employee passwords may be used for purposes of security but the use of a password does not affect the Company's ownership of the electronic information or ability to monitor the information. The Company may override an employee's password for any reason.

Employees are not permitted to access the electronic communications of other employees or third parties unless directed to do so by Organic Care management.

### **Prohibited Use**

All existing Company policies apply to employee use of computers, electronic communications, electronic information, and the Internet. This includes policies that deal with misuse of Company assets or resources. It is a violation of Organic Care policy to use computers, electronic communications, electronic information, or the Internet, in a manner that: is discriminatory harassing or obscene; constitutes copyright or trademark infringement; violates software licensing rules; is illegal; or is against Organic Care policy. It is also a violation of policy to use computers, electronic communications, electronic information, or the Internet to communicate confidential or sensitive information or trade secrets.

The display of any kind of sexually explicit multimedia content, message, or document on any Company computer is a violation of the Company's policy against sexual harassment. This description of prohibited usage is not exhaustive and it is within the discretion of Organic Care to determine if there has been a violation of this policy. Employees that engage in prohibited use will be subject to discipline and/or immediate termination.



This policy is not intended to limit the ability of employees to discuss with other employees the



terms and conditions of their employment, including such topics as wages, job performance, workload, supervisors, or staffing.

### **Computer and Internet Use**

Organic Care provides computers, electronic communications, electronic information, and information technology resources, including the Internet, to its employees to help them do their job. Generally, these Company resources should be used for business related purposes. However, the Company recognizes that occasional personal use of these Company resources and property may occur during working time. The Company allows such occasional personal use as long as the usage does not interfere with the employee's work performance, take away from work time, consume supplies, slow other users, slow the servers or computer systems, or tie up printers or other shared resources, or violate any Company policy, including policies against harassment, discrimination and disclosure of confidential or trade secret information.

This policy is not intended to limit the ability of employees to use Company email systems to communicate with other employees regarding the terms and conditions of their employment, including such topics as wages, job performance, workload, supervisors or staffing.

All policies relating to monitoring usage of Company property apply. Organic Care reserves the right to adjust this policy on a case by case basis as it deems appropriate.

### **Social Media**

Social media is a set of Internet tools that aid in the facilitation of interaction between people online. If you have specific questions about which programs the Company deems to be social media, consult with the owner(s) or President. The Company recognizes that occasional personal use of social media using Company resources may occur during working hours. The Company allows such occasional personal use as long as the usage does not interfere with the employee's work performance, take away from work time, consume supplies, slow other users, slow the servers or computer systems, or tie up printers or other shared resources, or violate any Company policy, including policies against harassment, discrimination and disclosure of confidential or trade secret information. All policies relating to monitoring usage of Company property apply. Organic Care reserves the right to adjust this policy on a case by case basis as it deems appropriate.

Employees can use their own personal devices to engage in social media during breaks and meal periods; however, all other company policies against inappropriate usage, including the Company's no tolerance for discrimination, harassment or retaliation in the workplace, and protection of confidential or trade secret information, apply.

Nothing in the Company's social media policy is designed to interfere with, restrain or prevent employee communications regarding wages, hours or other terms and conditions of employment.

### **Employee-owned Devices**



Organic Care recognizes that occasional use of the employee's own computers (including hand



held devices) and electronic communications may occur during working time. The Company allows such occasional personal use as long as the usage does not interfere with the employee's work performance, take away from work time or violate any Company policy. All other company policies, including the Company's no tolerance for discrimination, harassment or retaliation in the workplace apply. Organic Care reserves the right to adjust this policy on a case by case basis as it deems appropriate.

## Employer Property

Lockers, furniture, desks, computers, cell phones, data processing equipment/software, vehicles, and are Organic Care property and must be maintained according to Company rules and regulations. They must be kept clean and are to be used only for work-related purposes. Organic Care reserves the right to inspect all Company property including computer or phone data or messages to ensure compliance with its rules and regulations, without notice to the employee and at any time, not necessarily in the employee's presence. Prior authorization must be obtained before any Company property may be removed from the premises.

Company voice mail and/or electronic mail (e-mail) including texting, pagers and mobile email are to be used for business purposes. Organic Care reserves the right to monitor voice mail messages, and e-mail messages, and texts to ensure compliance with this rule, without notice to the employee and at any time, not necessarily in the employee's presence.

Organic Care may periodically need to assign and/or change "passwords" and personal codes for

- email
- voice mail
- computers
- cell phones

These communication technologies and related storage media and databases are to be used only for Company business and they remain the property of Organic Care.

Organic Care reserves the right to keep a record of all passwords and codes used and/or may be able to override any such password system. Messages on the company voice-mail and email systems are subject to the same company policies against discrimination and harassment as are any workplace communications. Offensive, harassing or discriminatory content in such messages will not be tolerated.

For security reasons, employees should not leave personal belongings of value in the workplace. Terminated employees should remove any personal items at the time they leave Organic Care. Personal items left in the workplace are subject to disposal if not claimed at the time of an employee's termination.



## Prohibiting Personal Use of Company Cell Phone

Cell phones (including handheld devices and smart phones such as iPhones) may be provided to some employees to assist them in performing their job. Cell phones are company property. Data (including web browsing), messages (including voice mail, mobile email, and text messaging), and other stored electronic information is subject to monitoring and the employee does not have an expectation of privacy in the use of this Company property.

The Company may ask you to assign a password to your Company cell phone to prevent unauthorized access. This password does not affect the Company's ownership of the cell phone or ability to monitor the information.

Company cell phones must not be used in any manner that violates any other Company policy, including safety policies, confidentiality policies, electronic and social media policies, and policies against discrimination and harassment.

Employees who are provided a Company cell phone may use it to send and receive occasional and limited personal communications. Any personal usage of a Company-issued cell phone must not interfere with the employee's work performance, take away from work time, or violate any Company policy, including policies against harassment, discrimination and disclosure of confidential or trade secret information. Employees are responsible for paying for additional time or data usage in excess of any rate plan maintained by the Company and unrelated to performance of job duties or following Company directions.

## Smoking

Smoking is strictly prohibited at this workplace. The smoking prohibition applies to all smoking devices, including, but not limited to, the use of electronic smoking devices, such as electronic cigarettes, pipes, hookahs, and vaping devices. Smoking is only allowed in the designated smoking areas.

## Solicitation and Distribution of Literature

In order to ensure efficient operation of the Company's business and to prevent disruption to employees, we have established control of solicitations and distribution of literature on Company property. Organic Care has enacted rules applicable to all employees governing solicitation, distribution of written material, and entry onto the premises and work areas. All employees are expected to comply strictly with these rules. Any employee who is in doubt concerning the application of these rules should consult with his or her supervisor.

No employee shall solicit or promote support for any cause or organization during his or her working time or during the working time of the employee or employees at whom such activity is directed. No employee shall distribute or circulate any written or printed material in work areas at any time, or during his or her working time or during the working time of the employee or employees at whom such activity is directed.

Under no circumstances will non-employees be permitted to solicit or to distribute written material for any purpose on Company property.



## **Employee Conduct**



## Conducting Personal Business

Employees are to conduct only Organic Care business while at work. Employees may not conduct personal business or business for another employer during their scheduled working hours.

## Confidential Information

**Each employee is responsible for safeguarding the confidential information obtained during employment.**

In the course of your work, you may have access to trade secrets or similarly protected proprietary or confidential information regarding Organic Care's business (such as financial data, research and development, marketing, business plans or strategies, suppliers, business partners or customers). You have a responsibility to prevent revealing or divulging any such information unless it is necessary for you to do so in the performance of your duties or as required by law.

Access to, or disclosure of, confidential information should be on a "need-to-know" basis and must be authorized by your supervisor. Any breach of this policy will not be tolerated and legal action may be taken by the Company.

This policy does not prohibit employees from confidentially disclosing trade secret, proprietary or confidential information to federal, state and local government officials, or to an attorney, when done to report or investigate a suspected violation of the law. Employees may also disclose the information in certain court proceedings if specific procedures to protect the information are followed. Nothing in this policy is intended to conflict with 18 U.S.C. sec. 1833(b) or create liability for disclosures of trade secrets that are expressly allowed by 18 U.S.C. sec. 1833(b).

## Conflicts of Interest

All employees must avoid situations involving actual conflict of interest. Personal or romantic involvement with a competitor, supplier, or subordinate employee of Organic Care, which impairs an employee's ability to exercise good judgment on behalf of the Company, can create an actual conflict of interest. Supervisor-subordinate romantic or personal relationships also can lead to supervisory problems, possible claims of sexual harassment, and morale problems.

An employee involved in any of the types of relationships or situations described in this policy should immediately and fully disclose the relevant circumstances to his or her immediate supervisor, or any other appropriate supervisor, for a determination about whether an actual conflict exists. If an actual conflict is determined, Organic Care may take whatever corrective action appears appropriate according to the circumstances. Failure to disclose facts shall constitute grounds for disciplinary action.





## Customer Relations

Employees are expected to be polite, courteous, prompt, and attentive to every customer. When an employee encounters an uncomfortable situation that he or she does not feel capable of handling, the general manager should be called immediately.

Ours is a service business and all of us must remember that the customer always comes first. Our customers ultimately pay all of our wages. Remember, while the customer is not always right, the customer is never wrong.

Customers are to be treated courteously and given proper attention at all times. Never regard a customer's question or concern as an interruption or an annoyance. You must respond to inquiries from customers, whether in person or by telephone, promptly and professionally.

Never place a telephone caller on hold for an extended period. Direct incoming calls to the appropriate person and make sure the call is received.

Through your conduct, show your desire to assist the customer in obtaining the help he or she needs. If you are unable to help a customer, find someone who can.

All correspondence and documents, whether to customers or others, must be neatly prepared and error-free. Attention to accuracy and detail in all paperwork demonstrates your commitment to those with whom we do business.

Never argue with a customer. If a problem develops or if a customer remains dissatisfied, ask your supervisor or the general manager to intervene.

## Dress Codes and Other Personal Standards

Employees are expected to wear clothing appropriate for the nature of our business and the type of work performed. Clothing should be neat, clean and tasteful. Avoid clothing that can create a safety hazard. Department managers may issue more specific guidelines.

Employees who need a reasonable accommodation because of religious beliefs, observances or practices should contact a company representative with day-to-day personnel responsibility and discuss the need for accommodation.

## Drug and Alcohol Abuse

Organic Care is concerned about the use of alcohol, marijuana, illegal drugs or controlled substances as it affects the workplace. Use of these substances, whether on or off the job can detract from an employee's work performance, efficiency, safety, and health, and seriously impair Company operations. In addition, the use or possession of these substances on the job constitutes a potential danger to the welfare and safety of other employees and exposes the Company to the risks of property loss or damage, or injury to other persons.

The following rules and standards of conduct apply to all employees while on Company property, at work, or working on Company business. The following are strictly prohibited by Company policy:

- Being under the influence of, or impaired by, an illegal or controlled substance, alcohol or marijuana while on the job.
- Using or possessing illegal or controlled substances, alcohol or marijuana while on the job (including the illegal use of prescription drugs and possessing drug paraphernalia)
- Distributing, selling, or purchasing of an illegal or controlled substance, alcohol or marijuana while on the job.

Violation of these rules and standards of conduct will not be tolerated. Organic Care also may bring the matter to the attention of appropriate law enforcement authorities.

In order to enforce this policy, Organic Care reserves the right to conduct searches of Company property or employees and/or their personal property, and to implement other measures necessary to deter and detect abuse of this policy.

An employee's conviction on a charge of illegal sale or possession of any controlled substance while off Company property will not be tolerated because such conduct, even though off duty reflects adversely on Organic Care. In addition, the Company must keep people who sell or possess controlled substances off Company premises in order to keep the controlled substances themselves off the premises.

Organic Care will encourage and reasonably accommodate employees with alcohol, marijuana or drug dependencies to seek treatment and/or rehabilitation. Employees desiring such assistance should request a treatment or rehabilitation leave. The Company is not obligated, however, to continue to employ any person whose performance of essential job duties is impaired because of drug, alcohol or marijuana use. Additionally, employees who are given the opportunity to seek treatment and/or rehabilitation, but fail to successfully overcome their dependency or problem, will not automatically be reemployed or be given a second opportunity to seek treatment and/or rehabilitation. This policy on treatment and rehabilitation is not intended to affect the Company's treatment of employees who violate the regulations described previously. Rather, rehabilitation is an option for an employee who acknowledges a chemical dependency and voluntarily seeks treatment to end that dependency.



## News Media Contacts

Employees may be approached for interviews or comments by the news media. Only contact people designated by the CEO may comment to news reporters on Organic Care policy or events relevant to Organic Care.

This policy does not limit an employee's right to discuss the terms and conditions of his or her employment, or to try and improve these conditions.

## Off-Duty Conduct

While Organic Care does not seek to interfere with the off-duty and personal conduct of its employees, certain types of off-duty conduct may interfere with the Company's legitimate business interests.

Off-duty conduct by an employee that directly conflicts with the Company's essential business interests and disrupts business operations will not be tolerated.

## Other Employment

While employed by Organic Care, employees are expected to devote their energies to their jobs with the Company.

Employment that directly conflicts with the Company's essential business interests and disrupts business operations is strictly prohibited.

Employees who wish to engage in additional employment that may create a real conflict of interest must submit a written request to Organic Care explaining the details of the additional employment. If the additional employment is authorized, Organic Care assumes no responsibility for it. Organic Care shall not provide workers' compensation coverage or any other benefit for injuries occurring from or arising out of additional employment. Authorization to engage in additional employment can be revoked at any time.

## Political Activity

Many employees participate in political activities on their own time. Company time, facilities, property or equipment (including all computers, networks, and electronic equipment) must not be used for an employee's outside political activities. Organic Care will not reimburse any employee for political contributions, and employees should not attempt to receive or facilitate such reimbursements.

Absent a formal statement by Organic Care announcing any political endorsements, employees must not, through their own actions, speech, contributions, or written communication, mislead others to believe that Organic Care officially endorses or opposes any candidates for political office that Organic Care itself has not publicly announced. Company employees are entitled to their own personal position.

The Company will not discriminate against employees based on their lawful political activity engaged in outside of work.

## Prohibited Conduct

Employees are expected to conduct themselves in a manner to further the Company's objectives. The following conduct is prohibited and will not be tolerated by Organic Care. This list of prohibited conduct is illustrative only; other types of conduct that threaten security, personal safety, employee welfare and Company operations also may be prohibited and will result in disciplinary action up to and including termination.

- Falsifying employment records, employment information, or other Company records;
- Inefficient or careless performance of job responsibilities or inability to perform job duties satisfactorily;
- Recording the work time of another employee or allowing any other employee to record your work time, or falsifying any time card, either your own or another employee's;
- Theft and deliberate or careless damage or destruction of any Company property, or the property of any employee or customer;
- Removing or borrowing Company property without prior authorization;
- Unauthorized use or misuse of Company equipment, time, materials, or facilities;
- Provoking a fight or fighting during working hours or on Company property;
- Participating in horseplay or practical jokes on Company time or on Company premises;
- Carrying firearms or any other dangerous weapons on Company premises at any time;
- Engaging in criminal conduct whether or not related to job performance;
- Causing, creating or participating in a disruption of any kind during working hours on Company property;
- Insubordination, including but not limited to failure or refusal to obey the orders or instructions of a supervisor or member of management, or the use of abusive or threatening language toward a supervisor or member of management;
- Using abusive, threatening or intimidating language at any time on Company premises;
- Violation of Company punctuality and attendance policies. Absences protected by state or federal law do not count as violations of this policy. Protected paid sick time under California law does not count as a violation of this policy;
- Failing to obtain permission to leave work for any reason during normal working hours, not including meal periods;
- Failing to observe working schedules, including rest and lunch periods;
- Sleeping or malingering on the job;
- Making or accepting personal telephone calls, including cell phone calls, of more than three minutes in duration during working hours, except in cases of emergency or extreme circumstances;
- Working overtime without authorization or refusing to work assigned overtime;
- Violation of dress standards;
- Violating any safety, health, security or Company policy, rule, procedure or violation of the Company's drug and alcohol policy;
- Committing a fraudulent act or a breach of trust under any circumstances;



- Violating the Company's anti-harassment or equal employment opportunity policies; and
- Failing to promptly report work-related injury or illness.

This statement of prohibited conduct does not alter the Company's policy of at-will employment. Either you or Organic Care remain free to terminate the employment relationship at any time, with or without reason or advance notice.

## **Prohibited Use of Company Cell Phone While Driving**

In the interest of the safety of our employees and other drivers, Organic Care employees are prohibited from using cell phones (including all smart phones) or other wireless communication devices (including laptops) while driving on Company business and/or Company time. This prohibition includes any use of the cell phone or other wireless communications device, such as answering or placing calls, engaging in conversations, texting, Web browsing or using any smart phone application while driving.

If your job requires that you keep your cell phone or other wireless communication device turned on while you are driving, you must use a hands-free, voice-operated device at all times. Under no circumstances should employees place phone calls while operating a motor vehicle while driving on Company business and/or Company time. Violating this policy is a violation of law and a violation of Company rules.

The prohibition would not apply to such a person using a wireless telephone or a mobile service device for emergency purposes. Violating this policy is a violation of law and a violation of Company rules.

Writing, sending, or reading text-based communication - including text messaging, instant messaging, e-mail, web browsing and use of smart phone applications - on a wireless device or cell phone while driving is also prohibited under this policy. Violating this policy is a violation of law and a violation of Company rules.

You must also safely pull off the road before conducting Company business.

## **Punctuality and Attendance**

As an employee of Organic Care, you are expected to be punctual and regular in attendance. Any tardiness or absence causes problems for your fellow employees and your supervisor. When you are absent, your assigned work must be performed by others.

Employees are expected to report to work as scheduled, on time, and prepared to start work. Employees also are expected to remain at work for their entire work schedule, except for meal periods or when required to leave on authorized Company business. Late arrivals, early departures or other unanticipated and unapproved absences from scheduled hours are disruptive and must be avoided.

If you are unable to report for work on any particular day, you must provide reasonable advance notice to your supervisor before the time you are scheduled to begin working for that day. You must inform your supervisor of the expected duration of any absence. If you fail to provide



reasonable advance notice before your scheduled time to begin work and do not arrive in time



for your assigned shift, you will be considered tardy for that day. If the circumstances for your tardiness or absence were unforeseen, inform your supervisor as soon as practicable of the reason for the tardiness or absenteeism.

Excessive absenteeism or tardiness, providing false information or abuse of leave laws will not be tolerated. Generally, if you fail to report for work without any notification to your supervisor and your absence continues for a period of 3 consecutive days, Organic Care will consider that you have voluntarily abandoned or quit your employment.

**Absences protected by local, state and federal law do not count as a violation of the punctuality and attendance policy. Paid sick time protected under California law does not count as a violation of this policy.**



**Wages**





## Deductions for Exempt Employees

Employees paid on a "salary basis" regularly receive a predetermined amount of compensation each pay period. Subject to the exceptions listed below, exempt employees will receive full salary for any workweek in which they perform any work, regardless of the number of days or hours worked. Exempt employees may not be paid for any workweek in which they perform no work, subject to Organic Care benefits programs and policies.

No deductions from salary may be made for time when work is not available, provided the exempt employee is ready, willing, and able to work. Deductions from pay are permissible when an exempt employee:

- Is absent from work for one or more full days for personal reasons other than sickness or disability;
- Is absent for one or more full days due to sickness or disability if the deduction is made in accordance with a bona fide plan, policy, or practice of providing full compensation for salary lost due to illness and the employee has exhausted his or her leave under this policy;
- Is absent for jury duty or military duty for a full week and performs no work during the week; or
- Works less than a full week during the initial or final week of employment;

Partial day deductions from available accrued vacation or sick leave balances will also be made by the Company when applicable.

It is Company policy to comply with these salary basis requirements. Therefore, Organic Care prohibits all Company managers from making any improper deductions from the salaries of exempt employees. The Company wants employees to be aware of this policy and know that the Company does not allow deductions that violate federal or state law.

If you believe that an improper deduction from your salary has been made, you should immediately report this information to your direct supervisor, or to \_\_\_\_\_

Reports of improper deductions will be investigated promptly. If it is determined that an improper deduction has occurred, you will be promptly reimbursed for any improper deduction made.

## Expense Accounts

Organic Care reimburses employees for business expenses on the end of the month of each month. Employees who have expense accounts or who have incurred business expenses must submit required receipts and the Manager to Manager no later than the 25th of each month.

If you have any questions about the Company's expense reimbursement policy, contact Manager.



## Meal and Rest Periods

### Rest Breaks

All nonexempt employees are entitled to uninterrupted rest break periods during their workday. If you are a nonexempt employee, you will be paid for all such break periods, and you will not clock out.

### Number of Rest Breaks

You will be authorized and permitted one (1) 10-minute net rest break for every four (4) hours you work (or major fraction thereof, which is defined as any amount of time over two [2] hours). A rest break need not be authorized for employees whose total daily work time is less than three and one half (3.5) hours.

You will be relieved of all duty during your rest break periods. You are free to come and go as you please and are free to leave the premises. You are expected to return to work promptly at the end of any rest break.

If you work a shift from three and one-half (3.5) to six (6) hours in length you will be entitled to one (1) ten-minute rest break. If you work more than six (6) hours and up to 10 hours, you will be entitled to two (2) ten-minute rest breaks. If you work more than 10 hours and up to 14 hours, you will be entitled to three (3) ten-minute rest breaks.

### Timing of Rest Breaks

You are authorized and permitted to take a rest break in the middle of each four hour work period.

Your rest break will be scheduled by Manager

### Meal Period

All nonexempt employees will be provided an uninterrupted unpaid meal period of at least 30 minutes if you work more than five (5) hours in a workday. You must clock out for your meal period. You will be permitted a reasonable opportunity to take this meal period, and you will be relieved of all duty. During your meal period, you are free to come and go as you please and are free to leave the premises. You are expected to return to work promptly at the end of any meal period.

### Timing of Meal Period

Your meal period will be provided no later than the end of your fifth hour of work. For example, if



you begin work at 8:00 a.m., you must start your meal period by 12:59 p.m. (which is before the end of your fifth hour of work).



Your meal period will be scheduled by Manager

#### **Second Meal Period**

If you work more than 10 hours in a day, you will be provided a second, unpaid meal period of at least 30 minutes. Again, you must clock out for your meal period. You will be permitted a reasonable opportunity to take this meal period, and you will be relieved of all duty. There will be no control over your activities during your meal period. During your meal period, you are free to leave the premises and are free to come and go as you please. You are expected to return to work promptly at the end of any meal period.

#### **Timing of Second Meal Period**

This second meal period will be provided no later than the end of your 10th hour of work.

Your second meal period will be scheduled by Manager.

#### **Recording Meal Periods**

You must clock out for any meal period and record the start and end of the meal period.

Employees are not allowed to work "off the clock." All work time must be accurately reported on your time record.

If for any reason you are not provided a meal period in accordance with our policy, or if you are in any way discouraged or impeded from taking your meal period or from taking the full amount of time allotted to you, please immediately notify Manager.

Anytime you miss a meal period that was provided to you (or you work any portion of a provided meal period), you will be required to report to Manager and document the reason for the missed meal period or time worked.

Please also refer to the Organic Care Timekeeping Policy.



## Overtime for Nonexempt Employees

Employees may be required to work overtime as necessary. Only actual hours worked in a given workday or workweek can apply in calculating overtime. Organic Care will attempt to distribute overtime evenly and accommodate individual schedules. All overtime work must be previously authorized by a supervisor. Organic Care provides compensation for all overtime hours worked by non-exempt employees in accordance with state and federal law as follows:

- All hours worked in excess of eight hours in one workday or 40 hours in one workweek will be treated as overtime. A workday begins at 12:01 a.m. and ends at midnight 24 hours later. Workweeks begin each Sunday at 12:01 a.m.;
- Compensation for hours in excess of 40 for the workweek, or in excess of eight and not more than 12 for the workday, and for the first eight hours on the seventh consecutive day of work in one workweek, shall be paid at a rate one and one-half times the employee's regular rate of pay;
- Compensation for hours in excess of 12 in one workday and in excess of eight on the seventh consecutive workday in a workweek shall be paid at double the regular rate of pay; and
- Exempt employees may have to work hours beyond their normal schedules as work demands require. No overtime compensation will be paid to exempt employees.

## Payment of Wages

Paychecks are normally available at the Manager office. If you observe an error on your check, please report it immediately to your supervisor.

All employees of Organic Care are paid every other Friday for work performed during the previous two-week pay period. If a regular payday falls on a holiday, employees will be paid on the workday before the holiday.

Organic Care offers automatic payroll deposit. You may begin and stop automatic payroll deposit at any time. To begin automatic payroll deposit, you must complete a form (available from the payroll department) and return it to payroll at least 10 days before the pay period for which you would like the service to begin. You should carefully monitor your payroll deposit statements for the first two pay periods after the service begins.

To stop automatic payroll deposit, complete the form available from the payroll department and return it to payroll at least 10 days before the pay period for which you would like the service to end. You will receive a regular payroll check on the first pay period after the receipt of the form, provided it is received no later than 10 days before the end of the pay period.



## Recruitment Bonus

Organic Care wants to recruit quality applicants and in order to do so encourages employees to refer qualified candidates to the Company. If your referral is employed by Organic Care, a recruiting bonus of \$500 will be paid to employees under the following terms and schedule:

- Referrals will be paid only if the original employment application completed by the applicant contains the employee's name as the referral source.
- After the applicant has been hired and completed one month of service, the referring employee will be paid \$100.
- After the referral has completed six months of service, the referring employee will be paid \$200.
- After the referral has completed one year of service, the referring employee will be paid \$200.
- If the applicant is referred by more than one employee, the referral bonus will be split equally among the referring employees and paid on the same terms as above.

## Timekeeping Requirements

All nonexempt employees are required to use a software to record time worked for payroll purposes. All time worked must be accurately reported on your time record.

Employees must record their own time at the start and at the end of each work period. Employees must clock out for their meal period and record the start and end of the meal period.

Employees are not allowed to work "off the clock." Working off the clock violates company policy. Any work performed before or after a regularly scheduled shift must be approved in advance by your supervisor. If you perform any off-the-clock work, please report the work to your supervisor.

Employees also must record their time whenever they leave the building for any reason other than Organic Care business.

Employees will be required to certify that their time record is accurate.

Any handwritten marks or changes on the timecard must be initialed by a supervisor. Punching another employee's timecard, allowing another employee to punch your timecard, or altering a timecard is not permissible and is subject to disciplinary action.

Any errors on your timecard should be reported immediately to your supervisor.

Please also refer to Organic Care's Meal and Rest Break Policy.



## **Safety and Health**



## Employees Who Are Required to Drive

Employees whose job duties require them to drive a Company vehicle or their own vehicles for Company business will be required to show proof of current valid driving licenses and proof of insurability under the Company's policy or current effective insurance coverage before the first day of employment.

Organic Care participates in a system that regularly checks state Department of Motor Vehicles (DMV) records of all employees who are required to drive as part of their job.

If an employee is required to drive as part of his or her job, Organic Care retains the right to transfer to an alternative position, suspend, or terminate an employee whose license is suspended or revoked, or who fails to maintain personal automobile insurance coverage or who is uninsurable under the Company's policy.

Employees who drive their own vehicles on Company business will be reimbursed at the current IRS rate per mile.

## Ergonomics

Organic Care is subject to Cal/OSHA ergonomics standards for minimizing workplace repetitive motion injuries. The Company will make necessary adjustments to reduce exposure to ergonomic hazards through modifications to equipment and processes and employee training. The Company encourages safe and proper work procedures and requires all employees to follow safety instructions and guidelines.

Organic Care believes that reduction of ergonomic risk is instrumental in maintaining an environment of personal safety and well-being, and is essential to our business. We intend to provide appropriate resources to create a risk-free environment. If you have any questions about ergonomics, please contact \_\_\_\_\_.

## Fragrance Policy

We strive to maintain a fragrance-free workplace. Employees may not wear any of the following in the workplace or when on the job, regardless of location, if they may come in contact with customers or coworkers: cologne, after shave lotion, perfume, perfumed hand lotion, fragranced hair products, fragranced deodorants and/or similar products.

## Health and Safety

All employees are responsible for their own safety, as well as that of others in the workplace. To help us maintain a safe workplace, everyone must be safety-conscious at all times. Report all work-related injuries or illnesses immediately to your supervisor or to the human resources department. In compliance with California law, and to promote the concept of a safe workplace, Organic Care maintains an Injury and Illness Prevention Program. The Injury and Illness Prevention Program is available for review by employees and/or employee representatives in the general manager's office.





In compliance with Proposition 65, Organic Care will inform employees of any known exposure to a chemical known to cause cancer or reproductive toxicity.



## Recreational Activities and Programs

Organic Care or its insurer will not be liable for payment of workers' compensation benefits for any injury that arises out of an employee's voluntary participation in any off-duty recreational, social, or athletic activity that is not part of the employee's work-related duties.

## Security

Organic Care has developed guidelines to help maintain a secure workplace. Be aware of persons loitering for no apparent reason in parking areas, walkways, entrances and exits, and service areas. Report any suspicious persons or activities to security personnel. Secure your desk or office at the end of the day. When called away from your work area for an extended length of time, do not leave valuable and/or personal articles in or around your workstation that may be accessible. The security of facilities as well as the welfare of our employees depends upon the alertness and sensitivity of every individual to potential security risks. You should immediately notify your supervisor when unknown persons are acting in a suspicious manner in or around the facilities, or when keys, security passes, or identification badges are missing.

## Workplace Violence

Organic Care has adopted the following workplace violence policy to ensure a safe working environment for all employees.

The Company has zero tolerance for acts of violence and threats of violence. Without exception, acts and threats of violence are not permitted. All such acts and threats, even those made in apparent jest, will be taken seriously, and will lead to discipline up to and including termination.

Possession of non-work related weapons on Company premises and at Company-sponsored events shall constitute a threat of violence.

It is every employee's responsibility to assist in establishing and maintaining a violence-free work environment. Therefore, each employee is expected and encouraged to report any incident which may be threatening to you or your co-workers or any event which you reasonably believe is threatening or violent.

You may report an incident to any supervisor or manager.

A threat includes, but is not limited to, any indication of intent to harm a person or damage Company property. Threats may be direct or indirect, and they may be communicated verbally or nonverbally. The following are examples of threats and acts that shall be considered violent - this list is in no way all-inclusive:

Example	Type of Threat
Saying, "Do you want to see your next birthday?"	Indirect
Writing, "Employees who kill their supervisors have the right idea."	Indirect
Saying, "I'm going to punch your lights out."	Direct
Making a hitting motion or obscene gesture	Nonverbal



Displaying weapons	Extreme
--------------------	---------



Stalking or otherwise forcing undue attention on someone, whether romantic or hostile	Extreme
Taking actions likely to cause bodily harm or property damage	Acts of violence

The Company's workplace violence program is described in detail in the Company's Illness and Injury Prevention Program (IIPP).



## Termination



## Employee References

All requests for references must be directed to \_\_\_\_\_ . No other manager, supervisor, or employee is authorized to release references for current or former employees.

By policy, Organic Care discloses only the dates of employment and the title of the last position held of former employees. If you authorize the disclosure in writing, Organic Care also will inform prospective employers of the amount of salary or wage you last earned.

## Involuntary Termination and Progressive Discipline

Violation of Organic Care policies and rules may warrant disciplinary action. The Company has a system of progressive discipline that may include verbal warnings, written warnings, and suspension. The system is not formal, and Organic Care may, in its sole discretion, utilize whatever form of discipline is deemed appropriate under the circumstances, up to, and including, immediate termination of employment. The Company's policy of progressive discipline in no way limits or alters the at-will employment relationship.

## Reductions in Force

Under some circumstances, Organic Care may need to restructure or reduce its workforce. If restructuring our operations or reducing the number of employees becomes necessary, the Company will attempt to provide advance notice, if possible, to help prepare affected individuals. If possible, employees subject to layoff will be informed of the nature of the layoff and the foreseeable duration of the layoff, whether short-term or indefinite.

In determining which employees will be subject to layoff, Organic Care will take into account, among other things, operation and requirements, the skill, productivity, ability, and past performance of those involved, and also, when feasible, the employee's length of service.

## Voluntary Resignation

Voluntary resignation results when an employee voluntarily quits his or her employment at Organic Care, or fails to report to work for three consecutively scheduled workdays without notice to, or approval by, his or her supervisor (unless the absence is protected by law). All Company-owned property, including vehicles, keys, uniforms, identification badges, and credit cards, must be returned immediately upon termination of employment.



## **Confirmation of Receipt**



## Confirmation of Receipt

I have received my copy of the Company's employee handbook. I understand and agree that it is my responsibility to read and familiarize myself with the policies and procedures contained in the handbook.

I understand and agree that nothing in the employee handbook creates or is intended to create a promise or representation of continued employment and that employment at Organic Care is employment at-will; employment may be terminated at the will of either the Company or myself. My signature certifies that I understand that the foregoing agreement on at-will status is the sole and entire agreement between Organic Care and myself concerning the duration of my employment and the circumstances under which my employment may be terminated. It supersedes all prior agreements, understandings, and representations concerning my employment with Organic Care.

I understand that except for employment at-will status, any and all policies or practices can be changed at any time by the Company. Organic Care reserves the right to change my hours, wages, and working conditions at any time. I understand and agree that other than the president of Organic Care, no manager, supervisor, or representative of the Company has authority to enter into any agreement, express or implied, for employment for any specific period of time, or to make any agreement for employment other than at-will; only the owner(s) or president has the authority to make any such agreement and then only in writing, signed by the owner(s) or president.

Employee's Signature \_\_\_\_\_

Employee's Printed Name \_\_\_\_\_

Date \_\_\_\_\_



23

Property Photo Plate



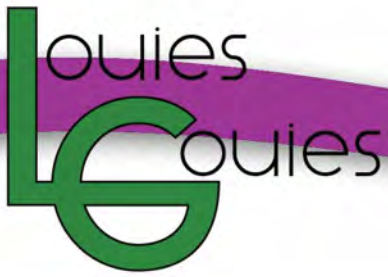

**Exterior Building Photographs for  
316 Yolanda Avenue, Santa Rosa, CA 95404**

## Aerial View of 316 Yolanda Avenue







A. East Front Facade To Be Improved with ADA Ramp and Landscaping



B. West Front Facade To Be Improved





C. Side (East) Facade with Driveway & Access Doors. Will be cleaned and maintained for visitors.



D. Rear Yard Sheds to Be Removed



E. View of Rear Yard Sheds



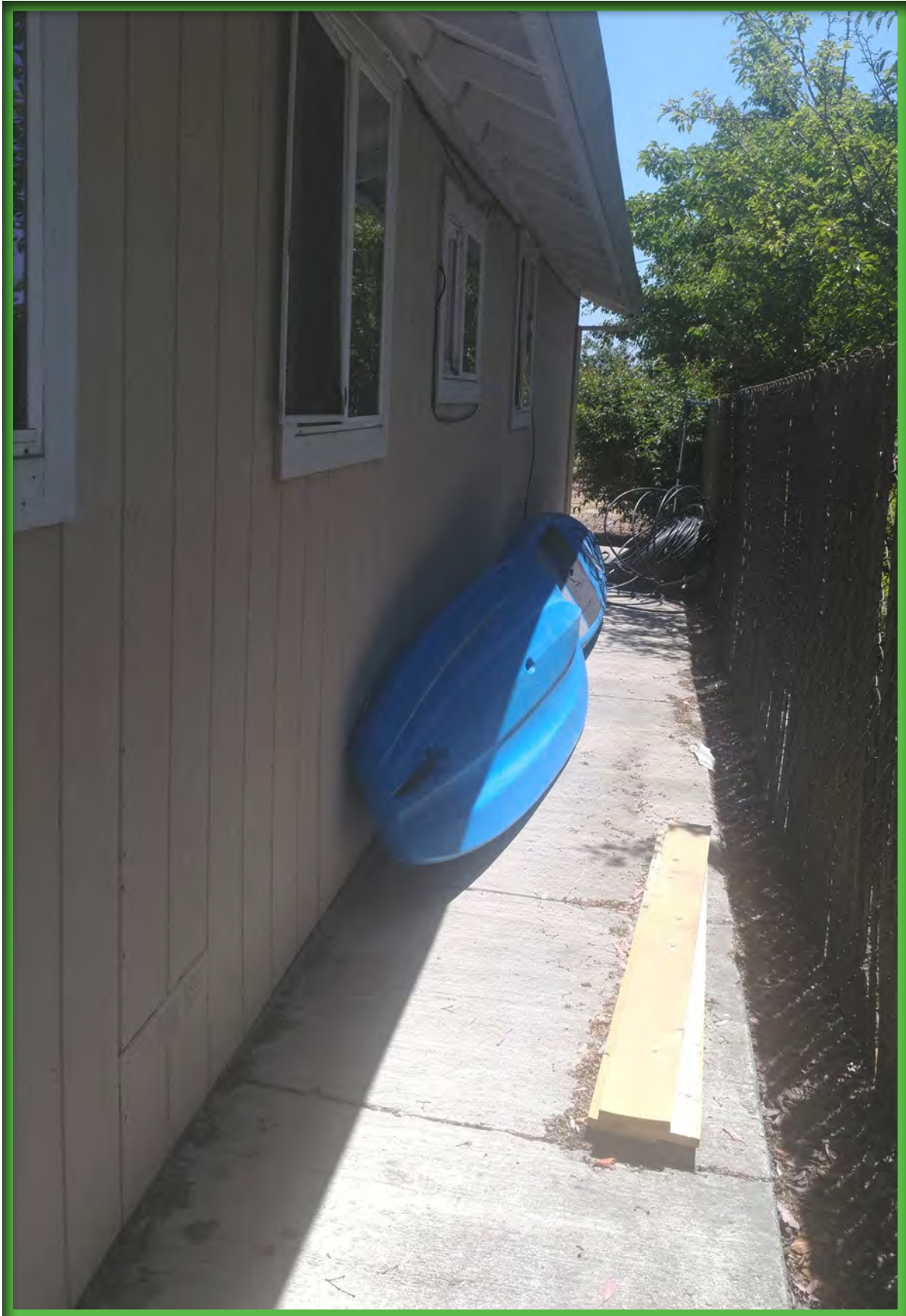

F. West Side Yard of Property With Existing Sidewalk for ADA Accessibility



**G. Front Entry to Be Improved with an Attractive Ramp, Railing, Parking Area, and Landscaping.**



**H. Newly Installed Dual Pane Windows in Good Condition with Minimal Maintenance Issues (Permit for Inserts Not Required)**





I. Dilapidated Rear Gate and Fence to be Removed



J. Rear Property Fence to be Replaced with Landscaped Parking Area



K. Rear Property Gate and Fence to be Replaced with Landscaping and Parking Area.



**23**

**Neighborhood Photo Plate**



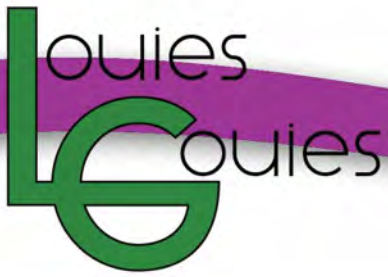

**Exterior Building Photographs for  
316 Yolanda Avenue, Santa Rosa, CA 95404**

## Aerial View of 316 Yolanda Avenue With Surrounding Properties and Businesses







A. Adjacent East Property



B. Adjacent East and South Property



C. Adjacent South Property



C. Adjacent Northwest Property





D. Adjacent North Property



E. Adjacent North Property



F. Adjacent Northeast Property



G. Adjacent West Property - Kenpo 5.0 Martial Arts





G. Left side of adjacent property - Subway.



G. Front of neighboring property - Starbucks



G. Neighboring property to the left - Malm Fireplace Central



G. Neighboring property on Santa Rosa - Batteries & Bulbs





G. Neighboring property on Santa Rosa - Metro PCS



G. Neighboring property - West Coast Auto Gallery



G. Neighboring property - 7 Eleven



G. Neighboring property directly across the street





G. Neighboring property - Magic Motors



G. Neighboring property - McDonald's on Santa Rosa Ave



# Materials Board



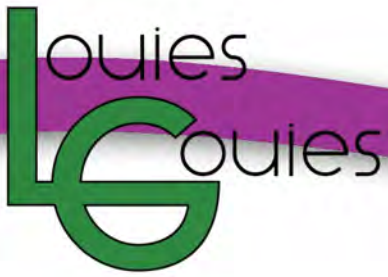

## **Materials Board**

**316 Yolanda Avenue, Santa Rosa, CA 95404**



Security door locking mechanism



Granite retail countertop



Interior security door



Exterior security door





Key card entry for restricted doors



High quality and stylized reception room



Glass retail case used interchangeably with granite countertop





High quality laminate flooring replacement throughout the building





 WEEDMAPS VERIFIED - Verified menu items let you know that you're getting authentic products from your favorite brands.



Indica (7)

Highest Eighth Price ▾

SHOW ALL PRICES









	<p><b>Edmans Og (Reg) 60</b></p> <p>INDICA</p>	<p>THC <span>---</span>%</p> <p>CBG <span>---</span>%</p> <p>CBN <span>---</span>%</p> <p>TERPENES <span>-----</span></p>	<p>1/8</p> <p><b>40.00</b></p>	<p>1/4</p> <p>---</p>
	<p><b>Green Crack (Reg) 60</b></p> <p>INDICA</p>	<p>THC <span>---</span>%</p> <p>CBG <span>---</span>%</p> <p>CBN <span>---</span>%</p> <p>TERPENES <span>-----</span></p>	<p>1/8</p> <p><b>29.00</b></p>	<p>1/4</p> <p>---</p>
	<p><b>Light Dep Sunset Sherbert (Reg)</b></p> <p>INDICA</p>	<p>THC <span>---</span>%</p> <p>CBG <span>---</span>%</p> <p>CBN <span>---</span>%</p> <p>TERPENES <span>-----</span></p>	<p>1/8</p> <p><b>20.00</b></p>	<p>1/4</p> <p><b>40.00</b></p>
	<p><b>SPECIAL 70 Oz Barry White</b></p> <p>INDICA</p>	<p>THC <span>---</span>%</p> <p>CBG <span>---</span>%</p> <p>CBN <span>---</span>%</p> <p>TERPENES <span>-----</span></p>	<p>1/8</p> <p>---</p>	<p>1/4</p> <p>---</p>
	<p><b>SPECIAL INDICA HIGH ON CBN</b></p> <p>INDICA</p>	<p>THC <span>---</span>%</p> <p>CBG <span>---</span>%</p> <p>CBN <span>---</span>%</p> <p>TERPENES <span>-----</span></p>	<p>1/8</p> <p>---</p>	<p>1/4</p> <p>---</p>
	<p><b>Special!! Cookies, Blue Dream</b></p> <p>INDICA</p>	<p>THC <span>---</span>%</p> <p>CBG <span>---</span>%</p> <p>CBN <span>---</span>%</p> <p>TERPENES <span>-----</span></p>	<p>1/8</p> <p>---</p>	<p>1/4</p> <p>---</p>
	<p><b>TMT</b></p> <p>INDICA</p>	<p>THC <span>---</span>%</p> <p>CBG <span>---</span>%</p> <p>CBN <span>---</span>%</p> <p>TERPENES <span>-----</span></p>	<p>1/8</p> <p><b>40.00</b></p>	<p>1/4</p> <p><b>100.00</b></p>



Sativa (8)

Highest Eighth Price ▾











SHOW ALL PRICES











	<p><b>\$2 grams 30 gram min</b></p> <p>SATIVA</p>	<p>THC --- %</p> <p>CBG --- %</p> <p>CBN --- %</p> <p>TERPENES -----</p>	<p>1/8 <b>25.00</b></p> <p>1/4 <b>40.00</b></p>
	<p><b>buy one get one</b></p> <p>SATIVA</p>	<p>THC --- %</p> <p>CBG --- %</p> <p>CBN --- %</p> <p>TERPENES -----</p>	<p>1/8 ---</p> <p>1/4 ---</p>
	<p><b>BUY ONE GET ONE Lemon Bu</b></p> <p>SATIVA</p>	<p>THC --- %</p> <p>CBG --- %</p> <p>CBN --- %</p> <p>TERPENES -----</p>	<p>1/8 ---</p> <p>1/4 ---</p>
	<p><b>Cookie Dough 75/14gram</b></p> <p>SATIVA</p>	<p>THC --- %</p> <p>CBG --- %</p> <p>CBN --- %</p> <p>TERPENES -----</p>	<p>1/8 ---</p> <p>1/4 <b>50.00</b></p>
	<p><b>Fruity cross buy one get one</b></p> <p>SATIVA</p>	<p>THC --- %</p> <p>CBG --- %</p> <p>CBN --- %</p> <p>TERPENES -----</p>	<p>1/8 ---</p> <p>1/4 ---</p>
	<p><b>SPECIAL 75 Indo (14 gram)</b></p> <p>SATIVA</p>	<p>THC --- %</p> <p>CBG --- %</p> <p>CBN --- %</p> <p>TERPENES -----</p>	<p>1/8 <b>30.00</b></p> <p>1/4 <b>60.00</b></p>
	<p><b>SPECIAL Sour Diesel</b></p> <p>SATIVA</p>	<p>THC --- %</p> <p>CBG --- %</p> <p>CBN --- %</p> <p>TERPENES -----</p>	<p>1/8 ---</p> <p>1/4 ---</p>
	<p><b>Super Sour Diesel</b></p> <p>SATIVA</p>	<p>THC --- %</p> <p>CBG --- %</p> <p>CBN --- %</p> <p>TERPENES -----</p>	<p>1/8 ---</p> <p>1/4 ---</p>

# Hybrid (24)

Highest Eighth Price ▾

[SHOW ALL PRICES](#)

	<p><b>Guava</b> </p> <p>HYBRID   CONNECTED CANNABIS CO.</p>	THC --- %	CBD --- %	CBG --- %	TERPENES -----	1/8 <b>50.00</b>	1/4 ---
	<p><b>Mochi</b> </p> <p>HYBRID   CONNECTED CANNABIS CO.</p>	THC --- %	CBD --- %	CBG --- %	TERPENES -----	1/8 <b>60.00</b>	1/4 <b>110.00</b>
	<p><b>#FIRESALE DosiDo</b></p> <p>HYBRID</p>	THC --- %	CBD --- %	CBG --- %	TERPENES -----	1/8 <b>40.00</b>	1/4 <b>70.00</b>
	<p><b>#RARE GMO GELATO CAKE</b></p> <p>HYBRID</p>	THC --- %	CBD --- %	CBG --- %	TERPENES -----	1/8 <b>70.00</b>	1/4 <b>140.00</b>
	<p><b>1\$ gram 60 gram min</b></p> <p>HYBRID</p>	THC --- %	CBD --- %	CBG --- %	TERPENES -----	1/8 <b>22.00</b>	1/4 <b>40.00</b>
	<p><b>14grm 75.00 Orange Cookies</b></p> <p>HYBRID</p>	THC --- %	CBD --- %	CBG --- %	TERPENES -----	1/8 <b>30.00</b>	1/4 ---
	<p><b>30% THC Cookies n Cream</b> (re</p> <p>HYBRID</p>	THC --- %	CBD --- %	CBG --- %	TERPENES -----	1/8 <b>45.00</b>	1/4 <b>80.00</b>
	<p><b>420 Special!!! Sun Grown: Che</b></p> <p>HYBRID</p>	THC --- %	CBD --- %	CBG --- %	TERPENES -----	1/8 ---	1/4 ---

	<b>Girl Scout Cookies</b> HYBRID	THC ---%	CBD ---%	CBN ---%	TERPENES -----	1/8 <b>25.00</b>	1/4 <b>45.00</b>
	<b>Girl Scout Cookies indoor (Reg)</b> HYBRID	THC ---%	CBD ---%	CBN ---%	TERPENES -----	1/8 <b>45.00</b>	1/4 ---
	<b>Golden Goat (Reg) 65</b> HYBRID	THC ---%	CBD ---%	CBN ---%	TERPENES -----	1/8 <b>55.00</b>	1/4 ---
	<b>Gorilla Glue (Reg) 60</b> HYBRID	THC ---%	CBD ---%	CBN ---%	TERPENES -----	1/8 <b>50.00</b>	1/4 ---
	<b>Gushers</b> HYBRID	THC ---%	CBD ---%	CBN ---%	TERPENES -----	1/8 <b>65.00</b>	1/4 ---
	<b>Indo Sunset Sherbs (Reg) 60</b> HYBRID	THC ---%	CBD ---%	CBN ---%	TERPENES -----	1/8 <b>40.00</b>	1/4 ---
	<b>Lem Og (Reg 65) 23.96% THC</b> HYBRID	THC ---%	CBD ---%	CBN ---%	TERPENES -----	1/8 <b>45.00</b>	1/4 <b>80.00</b>
	<b>Mimosa # 6 (Reg) 60</b> HYBRID	THC ---%	CBD ---%	CBN ---%	TERPENES -----	1/8 <b>50.00</b>	1/4 ---
	<b>Peanut Butter Breath</b> HYBRID	THC ---%	CBD ---%	CBN ---%	TERPENES -----	1/8 <b>55.00</b>	1/4 ---
	<b>Purple Punch (reg) 65</b> HYBRID	THC ---%	CBD ---%	CBN ---%	TERPENES -----	1/8 <b>45.00</b>	1/4 <b>95.00</b>





### Runtz (reg) 65

HYBRID

THC

CBG

CBN

TERPENES

1/8

1/4

60.00

110.00



### SALE Connected Products

HYBRID

THC

CBG

CBN

TERPENES

1/8

1/4

110.00



### Sale Connected Products

HYBRID

THC

CBG

CBN

TERPENES

1/8

1/4

110.00



# Extract (34)

Highest Half Gram Price ▾

[SHOW ALL PRICES](#)

	<p><b>.7 Cartidges (reg) 65</b> CONCENTRATE</p>	THC ---	CBD ---	CBN ---	TERPENES -----	.5G ---	1G <b>50.00</b>
	<p><b>3 for 90</b> CONCENTRATE</p>	THC ---	CBD ---	CBN ---	TERPENES -----	.5G ---	1G ---
	<p><b>Baller Buckets (Reg) 450 Today</b> CONCENTRATE</p>	THC ---	CBD ---	CBN ---	TERPENES -----	.5G ---	1G <b>60.00</b>
	<p><b>Beezle Extracts (Reg Price \$30)</b> CONCENTRATE</p>	THC ---	CBD ---	CBN ---	TERPENES -----	.5G <b>25.00</b>	1G ---
	<p><b>Beezle Lemon Tree Black Label</b> CONCENTRATE</p>	THC ---	CBD ---	CBN ---	TERPENES -----	.5G ---	1G <b>90.00</b>
	<p><b>Critical Zkittlez (Reg Price \$55)</b> CONCENTRATE</p>	THC ---	CBD ---	CBN ---	TERPENES -----	.5G <b>45.00</b>	1G <b>80.00</b>
	<p><b>Eel River Dirty Zprite (Reg Price \$85)</b> CONCENTRATE</p>	THC ---	CBD ---	CBN ---	TERPENES -----	.5G ---	1G <b>85.00</b>
	<p><b>First Class Concentrate (Reg Price \$40)</b> CONCENTRATE</p>	THC ---	CBD ---	CBN ---	TERPENES -----	.5G <b>40.00</b>	1G ---
	<p><b>First Class Concentrate (Reg Price \$40)</b> CONCENTRATE</p>	THC ---	CBD ---	CBN ---	TERPENES -----	.5G <b>40.00</b>	1G ---



### First Class Concentrates (Reg

CONCENTRATE

THC ---% CBD ---% CBN ---% TERPENES -----

.5G 1G  
**40.00 80.00**



### Gold Magic 'Muffins'

CONCENTRATE

THC ---% CBD ---% CBN ---% TERPENES -----

.5G 1G  
**29.00 ---**



### Gold Magic (reg) 40

CONCENTRATE

THC ---% CBD ---% CBN ---% TERPENES -----

.5G 1G  
**29.00 ---**



### Gold Magic Blue Skittles

CONCENTRATE

THC ---% CBD ---% CBN ---% TERPENES -----

.5G 1G  
**29.00 ---**



### Gold Magic Grape Pie

CONCENTRATE

THC ---% CBD ---% CBN ---% TERPENES -----

.5G 1G  
**29.00 ---**



### Gold Magic Purple Punch

CONCENTRATE

THC ---% CBD ---% CBN ---% TERPENES -----

.5G 1G  
**29.00 ---**



### Gold Magic Purple Punch Live

CONCENTRATE

THC ---% CBD ---% CBN ---% TERPENES -----

.5G 1G  
**29.00 ---**



### Grand Daddy Purple (Reg) 120

CONCENTRATE

THC ---% CBD ---% CBN ---% TERPENES -----

.5G 1G  
**38.00 50.00**



### HINDU ZKITTLEZ 3rd Generation

CONCENTRATE

THC ---% CBD ---% CBN ---% TERPENES -----

.5G 1G  
**--- 90.00**











### Humboldt Terp Council (Reg P)

CONCENTRATE

THC ---% CBD ---% CBN ---% TERPENES -----

.5G 1G  
**--- 130.00**



	<b>Humboldt's Finest Citrus Og (1)</b> CONCENTRATE	THC ---%	CBD ---%	CBN ---%	TERPENES -----	.5G ---	1G <b>90.00</b>
	<b>Illuminati Og Gold Magic</b> CONCENTRATE	THC ---%	CBD ---%	CBN ---%	TERPENES -----	.5G <b>29.00</b>	1G ---
	<b>Irish Cream</b> CONCENTRATE	THC ---%	CBD ---%	CBN ---%	TERPENES -----	.5G ---	1G <b>35.00</b>
	<b>MendoFire (Reg Price \$99.00)</b> CONCENTRATE	THC ---%	CBD ---%	CBN ---%	TERPENES -----	.5G <b>85.00</b>	1G ---
	<b>Noble Headspace (Reg Price \$69.00)</b> CONCENTRATE	THC ---%	CBD ---%	CBN ---%	TERPENES -----	.5G ---	1G <b>69.00</b>
	<b>Noble Headspace (Reg Price \$74.00)</b> CONCENTRATE	THC ---%	CBD ---%	CBN ---%	TERPENES -----	.5G ---	1G <b>74.00</b>
	<b>Noble Headspace (Reg Price \$69.00)</b> CONCENTRATE	THC ---%	CBD ---%	CBN ---%	TERPENES -----	.5G ---	1G <b>69.00</b>
	<b>Orange Tree (Reg Price \$50.00)</b> CONCENTRATE	THC ---%	CBD ---%	CBN ---%	TERPENES -----	.5G <b>45.00</b>	1G ---
	<b>SAUCE 3 GR FOR 90 GREASE</b> CONCENTRATE	THC ---%	CBD ---%	CBN ---%	TERPENES -----	.5G ---	1G <b>40.00</b>



### Shatter

CONCENTRATE

THC

CBD

CBN

TERPENES

5G

1G

---%

---%

---%

-----

---

**22.00**



### Shatter

CONCENTRATE

THC

CBD

CBN

TERPENES

5G

1G

---%

---%

---%

-----

---

**18.00**



### Terp Preservation Society (Reg)

CONCENTRATE

THC

CBD

CBN

TERPENES

5G

1G

---%

---%

---%

-----

---

**85.00**



### Wax Butter (Sale) 45 (Reg)

CONCENTRATE

THC

CBD

CBN

TERPENES

5G

1G

---%

---%

---%

-----

---

**35.00**



### Wax Dab

CONCENTRATE

THC

CBD

CBN

TERPENES

5G

1G

---%

---%

---%

-----

---

**25.00**



### ZKITTLEZ 3rd Generation Fat

CONCENTRATE

THC

CBD

CBN

TERPENES

5G

1G

---%

---%

---%















-----

---

**90.00**

# Edible (10)

Highest Price ▾

	<b>BROWNIES - 500MG</b>  EDIBLE   LOL EDIBLES	THC ---%	CBD ---%	CBN ---%	TERPENES -----	EACH <b>18.00</b>
	<b>G-BAR - 250MG</b>  EDIBLE   LOL EDIBLES	THC ---%	CBD ---%	CBN ---%	TERPENES -----	EACH <b>18.00</b>
	<b>LOOP FRUITS INFUSED CERE</b>  EDIBLE   LOL EDIBLES	THC ---%	CBD ---%	CBN ---%	TERPENES -----	EACH <b>18.00</b>
	<b>Chocolate Cupcake</b> EDIBLE	THC ---%	CBD ---%	CBN ---%	TERPENES -----	EACH <b>10.00</b>
	<b>Gummy's</b> EDIBLE	THC ---%	CBD ---%	CBN ---%	TERPENES -----	EACH <b>24.00</b>
	<b>LOL Edibles Jolly Rocker</b> EDIBLE	THC ---%	CBD ---%	CBN ---%	TERPENES -----	EACH <b>6.00</b>
	<b>Straws Super Infused</b> EDIBLE	THC ---%	CBD ---%	CBN ---%	TERPENES -----	EACH <b>16.00</b>
	<b>Super Infused Cookie</b> EDIBLE	THC ---%	CBD ---%	CBN ---%	TERPENES -----	EACH <b>20.00</b>
	<b>Super Infused Peanut Butter</b>  EDIBLE	THC ---%	CBD ---%	CBN ---%	TERPENES -----	EACH <b>15.00</b>
	<b>Super Infused Straw 420 spec</b> EDIBLE	THC ---%	CBD ---%	CBN ---%	TERPENES -----	EACH <b>15.00</b>

# Preroll (1)

Highest Price ▼



## Pre-roll With Live Resin (reg)

PREROLL

THC

10.5%

CBG

10.5%

CBN

10.5%

TERPENES

EACH

**18.00**





## Section P – Product Brochures



ACEPAY

## ACEpay: The Compliant Solution to Cannabis Banking

### Amercanex: A Comprehensive Ecosystem for Cannabis Regulation

Amercanex Corporation, a subsidiary of GreenTree International, is a financial technology company that has created an innovative, comprehensive regulatory ecosystem that addresses the regulatory and business challenges of the cannabis industry. The technology includes a track and trace solution (ACEtrak, powered by Adilas) that follows cannabis products from the seed all the way to the consumer, an electronic wholesale marketplace for licensed participants (ACE Marketplace), and finally, a mobile payment solution with fiscal management services (ACEpay, powered by Verstepay) that connect cannabis businesses with credit unions and banks in a transparent, federally and state-compliant manner, effectively changing the game for the cannabis industry. For the first time ever, regulatory oversight, control mechanisms, and tax verification and collection measures are within reach for government and regulatory authorities. This fact sheet focuses on the ACEpay solution. If interested in any of our other Amercanex products, please reach out to the contacts below.

#### ACEpay: Digitization of Cannabis Payments

ACEpay operates as a closed-loop membership payment system. It is an e-wallet solution that members can use to send and receive payments that is fully compliant with federal and state fiscal laws. All funds are held 100% traceable, verifiably clean, and held at partner credit unions and banks. The end result is that ACEpay members (i.e. cannabis entrepreneurs, regulatory agencies, ancillary businesses, etc.) are able to freely use the cashless, electronic funds from their account for non-cannabis needs: filling up at the gas pump, grocery shopping, paying mortgages, purchasing healthcare benefits and more.

#### How It Works.

ACEpay operates as a non-bank financial institution. Payments are conducted either using a membership account or through smart-safe technology in cases when cash transactions are allowed. Members can either use the e-wallet technology or a pre-paid card for payments. We perform a full "Know Your Client" audit and screening on every member upon opening an ACEpay account, during fund movements, and on a daily basis to ensure that members are suitable for working with our partner credit unions and banks. Our partner credit unions and banks also perform their own audit and screens to satisfy their requirements. What happens next? Every transaction is reported, keeping all parties accountable. All taxes due are verified and collected. Proprietary algorithms are utilized at all times to search for and detect unusual activity. All

suspicious activity is reported as required to the proper agencies.

#### The ACEpay Difference: No Masking, Just Compliance.

Risk minimization is a cornerstone of the ACEpay solution. Our leadership team has decades of experience working in the financial industry and fully understands federal and state banking regulations and compliance. As such, unlike other solutions, we do not act as an intermediary for funds from cannabis businesses. We ensure that our members' funds are held by our partner credit unions and banks in a transparent manner: banks know who our cannabis clients are and what they do. Furthermore, ACEpay goes above and beyond in terms of compliance with federal and state fiscal laws. Our technology is not only compliant with the 2013 Cole Memo and FinCEN Memo, but it also meets the standards of Dodd-Frank and the Bank Secrecy Act. Our policy and procedures manual contains a robust anti-money laundering program that meets or exceeds U.S. and international standards. If any investigations are conducted, we have the records to show our full compliance with federal and state laws.

#### Where We Are.

The ACEpay solution is fully operational in Colorado with beta pilots currently functioning in California, Pennsylvania, Nevada and Puerto Rico. We are also in discussion with Canadian officials as they prepare to roll out full recreational use of cannabis in July 2018.



ACEEXCHANGE

#### Contact Information:

Steve Janjic, CEO | [Steve.Janjic@amercanex.com](mailto:Steve.Janjic@amercanex.com) Michael Herron, COO | [Michael.Herron@amercanex.com](mailto:Michael.Herron@amercanex.com)  
(720) 360-1200

# How Does ACE Work?

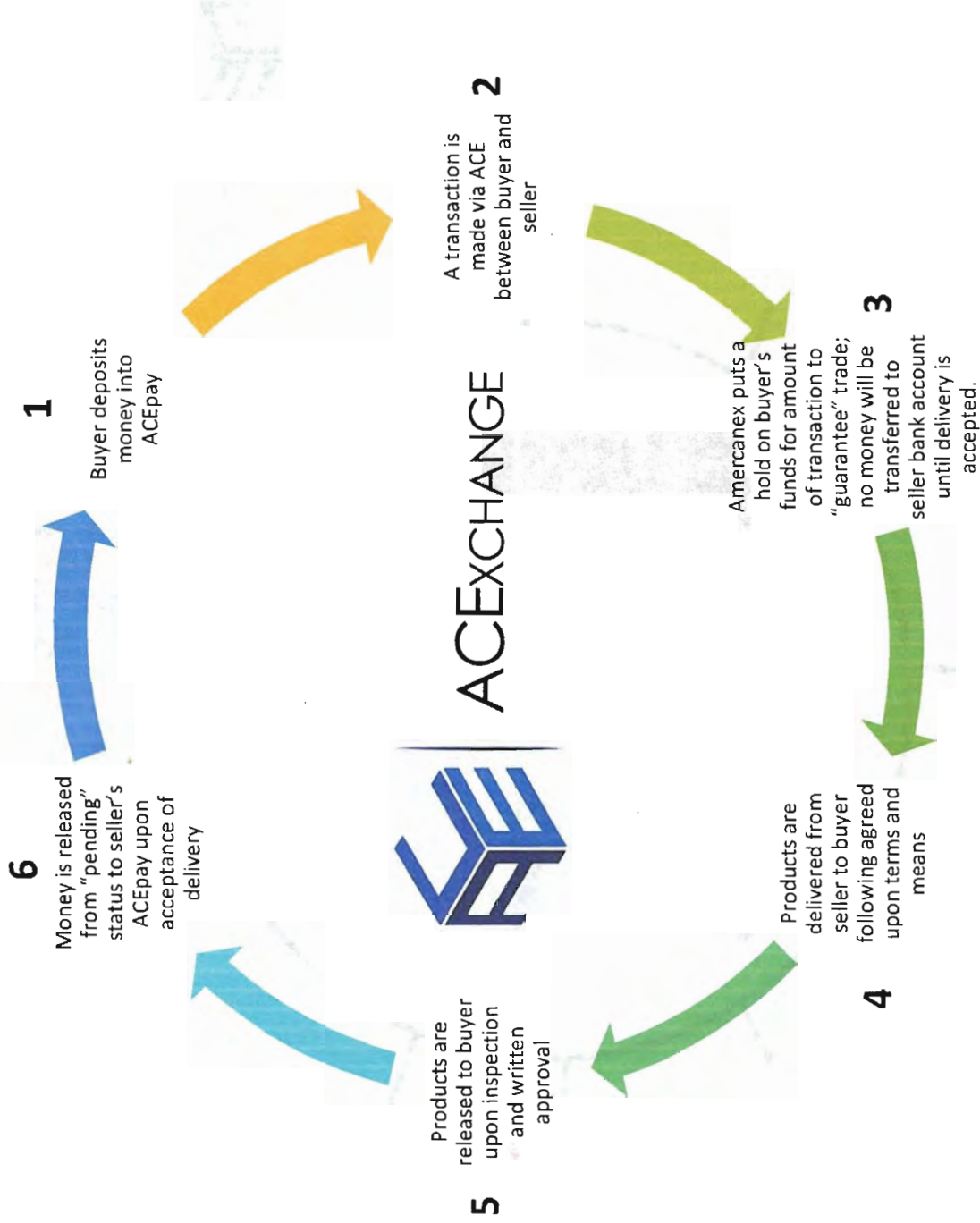



GSS-Doors

TEL

1-406-212-2334

EMAIL

rg@gssdoors.com

WEB

www.gssdoors.com

## FORTRESS SERIES

*Our flagship door, designed for locations at very high risk of attack or forced entry*

The Fortress Series is designed to help create a secure environment for locations with extremely high threat profiles or security challenges. It was tested at NTS Chesapeake in Belcamp, MD to the US State Department (DoS) forced entry standard SD-STD.01.01 Rev. G at the 15 minute level (FE 15). It was also tested at the iFT Rosenheim laboratory in Germany and was awarded a resistance class 4 (RC4) rating according to EN1627.

### TECHNICAL SPECS

- Door and frame constructed from 12 AWG steel
- Armored multi-point locking system with up to 20 locking points  $\frac{3}{4}$ "  $\varnothing$
- Locks encased in drill resistant manganese
- Door thickness: 3.5" (91mm)
- Frame thickness: 4.5" (115mm)
- Handgun or rifle level ballistic resistance - **optional**
- 90 minute UL fire rating - **optional**
- Welded, adjustable ball bearing security hinges
- $\frac{1}{2}$ " (12mm) or  $\frac{3}{4}$ " (18mm) thick decorative panels
- 2" of rock wool for sound and thermal insulation
- Door is pre-hung to the frame
- L-shaped frame profile
- Frame is secured in the wall using 16 bolts protected by 1" steel shims.
- Unlimited design and glass options

12 Active locking bolts



8 Hinge side inactive bolts

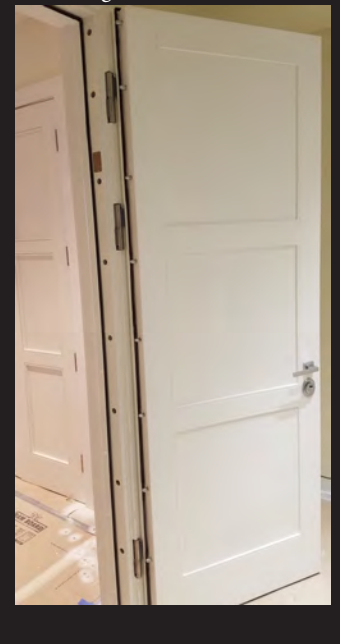

### HARDWARE

- High security bump and pick resistant Mul-T-Lock cylinders
- Drill resistant cylinder defenders
- Available lock options: Mottura 85 series (mechanical) or Fiam X1R (motorized)
- Lockout function - optional with mechanical lock only

### DIMENSIONS

- Height: up to 110" (depending on decorative panels)
- Width: up to 49"
- Inswing or outswing

### FB4 BALLISTIC (EQV.UL752 - LEVEL 3)

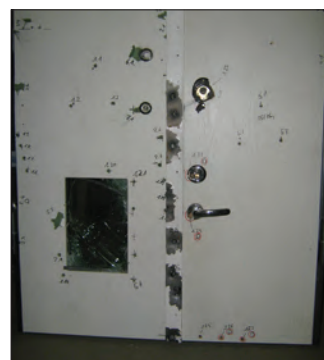

ATTACK SIDE



SECURE SIDE





GSS-Doors  
TEL 1-406-212-2334  
EMAIL rg@gssdoors.com  
WEB www.gssdoors.com

## State Department Forced Entry 15 Testing

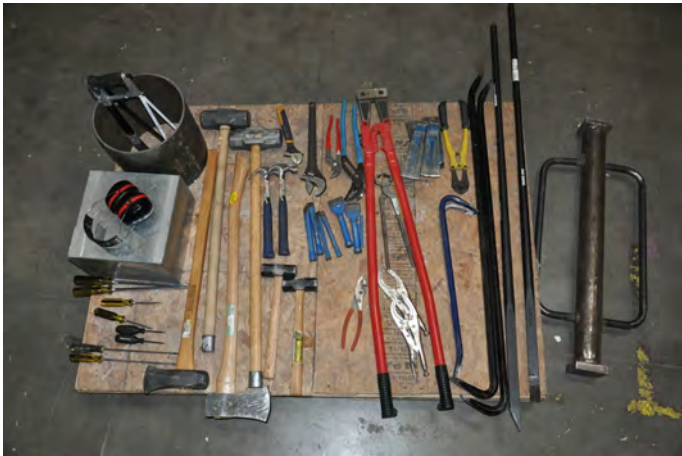

## State Department Bullet Resistant Tested Up To Level 8





GSS-Doors

TEL

1-406-212-2334

EMAIL

rg@gssdoors.com

WEB

www.gssdoors.com

## CROSS SECTIONS

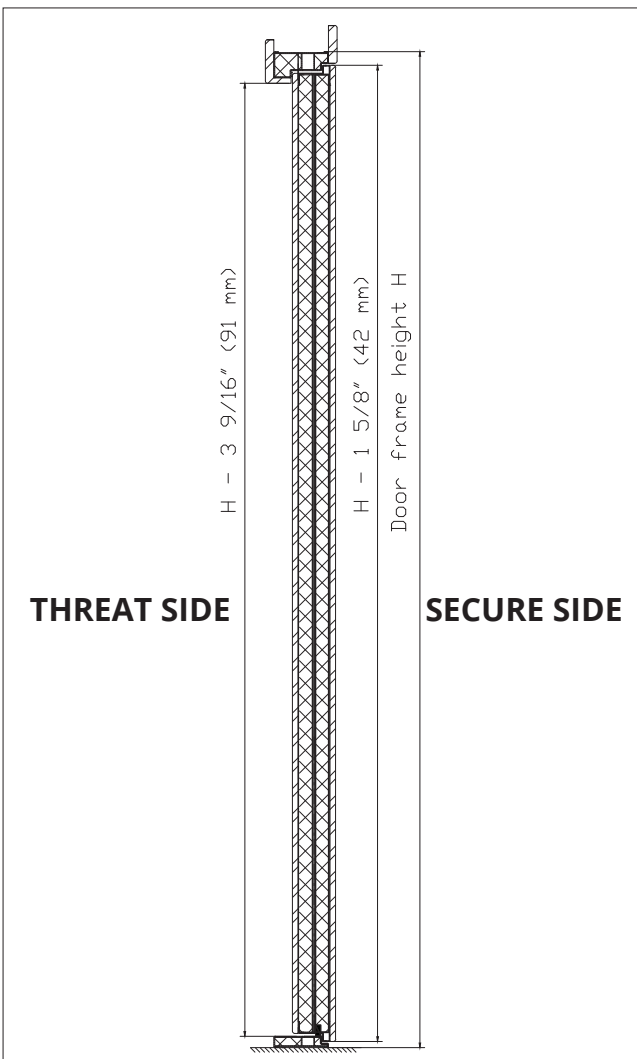
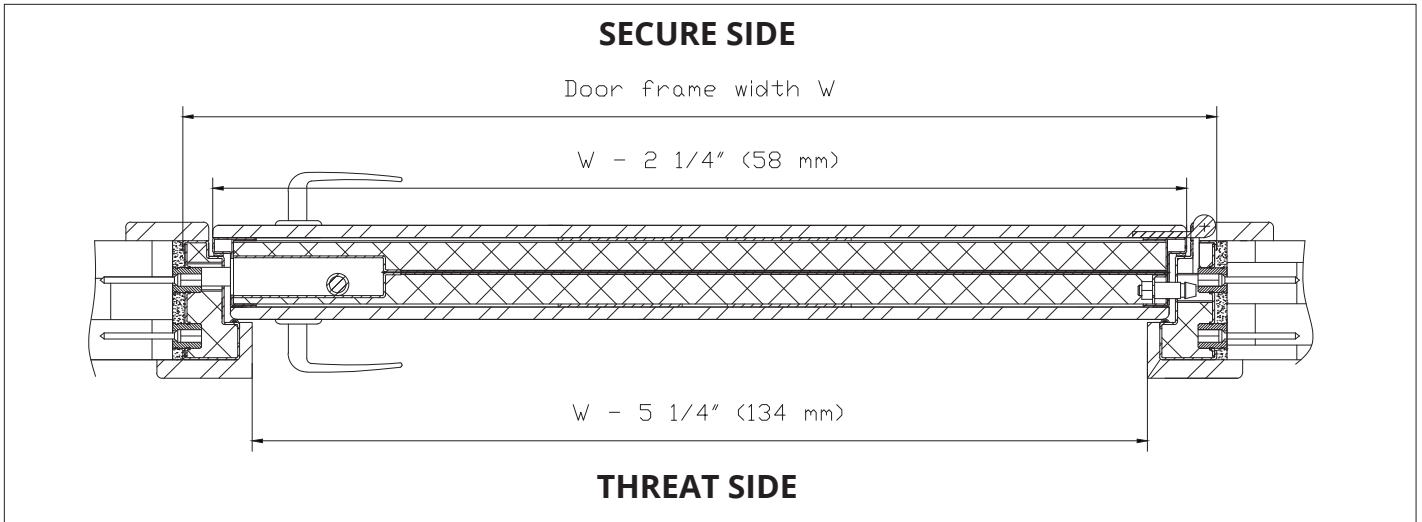

## INSTALLATION FAQ

- The Fortress series comes as a pre-hung door set and includes frame, locks, cylinders, handles, hinges, and hardware.
- It can be installed by any licensed GC or door installer.
- No specialized training or tools required!
- A 1/2" to 3/4" gap is required on all sides between the frame and wall (rough opening).
- The Fortress series frame is designed to adapt to crooked walls and openings.
- For detailed instructions, **download** our installation manual.



## CRL Stock Standard Inset Frame Exchange Window

- With Bullet Resistant Speak-Thru and Shelf With Deal Tray
- Fits Walls at Least 4-7/8" (124 mm) Thick
- Assembled and Ready to Install

This Standard Inset Frame Exchange Window is designed for walls with a thickness of at least 4-7/8" (124 mm). The unit slides into the opening and is secured by installing screws through the perimeter frame and into the sides of the opening. Window is supplied with a 12" (305 mm) deep Stainless Steel Shelf with built-in Non-Ricochet Bullet Resistant Deal Tray. Glazing is 1-1/4" (32 mm) thick bullet resistant acrylic with a Level 1 protection rating. The Cat. No. N666 Level 3 rated Stainless Steel Speak-Thru allows natural voice transmission (see page GG167). An overhang or awning is recommended if used in an exterior application. Two finishes and two sizes are available in stock. Custom units are available go to [crlaurence.com/bullet-resistant](http://crlaurence.com/bullet-resistant).

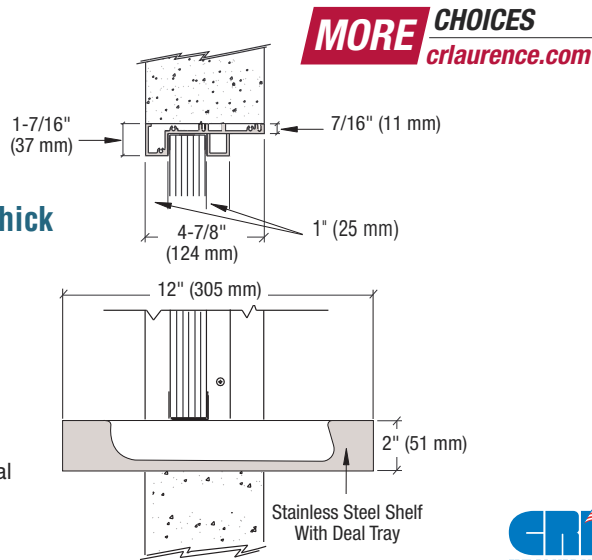

**MORE INFORMATION**  
[crlaurence.com](http://crlaurence.com)

### SPECIFICATIONS:

**Materials:** Frame - .125" (3.2 mm) Thick Extruded 6063-T5 Aluminum Alloy; Glazing - 1-1/4" (32 mm) Level 1 Acrylic; Shelf - Stainless Steel

**Finishes:** Frame - Satin Anodized or Duranodic Bronze; Shelf - Brushed Stainless Steel #4 Finish 16 Gauge

**Speak-Thru:** N666 Level 3 Stainless Steel

**Deal Tray:** Level 1 Protection

**Instructions Included**

CAT. NO.	FINISH	OVERALL SIZE (W X H)	WALL OPENING SIZE (W X H)
S1EW2436A	Satin Anodized	24" x 36" (610 x 914 mm)	24-1/2" x 36-1/4" (622 x 921 mm)
S1EW2436DU	Duranodic Bronze	24" x 36" (610 x 914 mm)	24-1/2" x 36-1/4" (622 x 921 mm)
S1EW3636A	Satin Anodized	36" x 36" (914 x 914 mm)	36-1/2" x 36-1/4" (927 x 921 mm)
S1EW3636DU	Duranodic Bronze	36" x 36" (914 x 914 mm)	36-1/2" x 36-1/4" (927 x 921 mm)

Minimum order: 1 each. F.O.B. All CRL Service Centers.

## CRL Night Service Window

- Glazed With 1-1/4" (32 mm) Bullet Resistant Level 1 Acrylic
- Stainless Steel Shelf With Non-Ricochet Bullet Resistant Tray
- Assembled and Ready to Install

Our Night Service Window is of the kind frequently used for motel registration or 24 hour service station windows. The 16 gauge stainless steel housing is glazed with 1-1/4" (32 mm) bullet resistant acrylic. This is mounted on a 16 gauge stainless steel shelf that measures 14-3/16" (360 mm) wide x 18" (457 mm) deep x 2" (51 mm) thick. The shelf has a Non-Ricochet Bullet Resistant Tray for passing cash, credit cards, keys, etc. The entire unit slides into a wall opening roughly 14-3/4" (375 mm) wide x 20" (508 mm) high. The flange surrounding the wall opening is 2" (51 mm) wide. Custom size units are available to suit your needs. The Standard unit does not have a speak-thru. Voice transmission is via the cash tray. An overhang is recommended for exterior use.

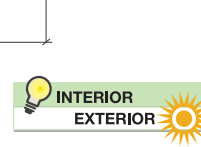
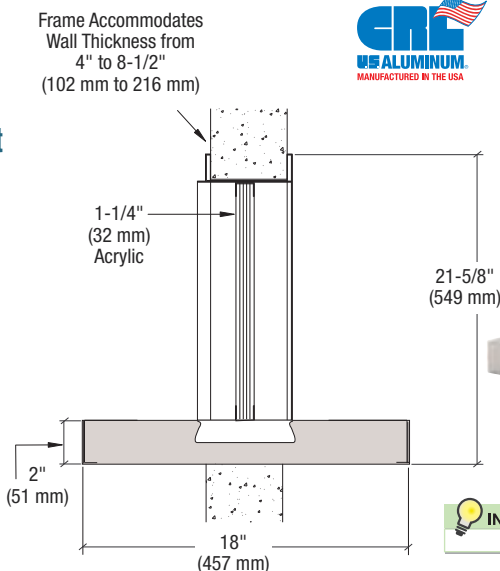

### SPECIFICATIONS:

**Materials:** 16 Gauge Stainless Steel; Clear Acrylic

**Glazing:** 1-1/4" (32 mm) Level 1 Acrylic

**Finish:** Brushed Stainless Steel #4 Finish

**Deal Tray:** Level 1 Protection

**Instructions Included**

CAT. NO.	OVERALL SIZE (W X H)	WALL OPENING SIZE (W X H)
SW101N	18-3/16" x 18" x 21-5/8" (462 x 457 x 549 mm)	14-3/4" x 20" (375 x 508 mm)

Minimum order: 1 each. F.O.B. All CRL Service Centers.

go to [crlaurence.com](http://crlaurence.com) to search for

**bullet-resistant**

Search

or enter the Catalog Number for complete product information

**GG161**

**TOLL Phone:** (800) 421-6144  
**FREE Fax:** (800) 262-3299  
 From Anywhere in the U.S. or Canada



🏠 [\\_ \(HTTPS://WWW.GOKEYLESS.COM\)](https://www.gokeyless.com) > [PRODUCTS \(HTTPS://WWW.GOKEYLESS.COM/SHOP/\)](https://www.gokeyless.com/shop/) > [COMMERCIAL \(HTTPS://WWW.GOKEYLESS.COM/SHOP/COMMERCIAL-KEYLESS-LOCKS/\)](https://www.gokeyless.com/shop/commercial-keyless-locks/) > [ELECTRONIC \(HTTPS://WWW.GOKEYLESS.COM/SHOP/COMMERCIAL-KEYLESS-LOCKS/ELECTRONIC-COMMERCIAL-LOCKS/\)](https://www.gokeyless.com/shop/commercial-keyless-locks/electronic-commercial-locks/)



# TRILOGY PDL3000 PROX CARD LOCK WITH AUDIT TRAIL

\$889.61 - \$1,135.31

Finish

Key Override

**ADD TO CART**

<https://www.gokeyless.com/wp-content/uploads/2015/03/257.jpg>



<https://www.gokeyless.com/wp-content/uploads/2015/03/257.jpg> <https://www.gokeyless.com/wp-content/uploads/2015/03/257.jpg> <https://www.gokeyless.com/wp-content/uploads/2015/03/257.jpg> <https://www.gokeyless.com/wp-content/uploads/2015/03/257.jpg>

**SAFE AND SECURE**  
100% Price & Performance Guarantee

<https://www.gokeyless.com/30-day-money-back-guarantee/>

SKU: PDL3000

Features

Description

Specs

Reviews (7)

Customer Q&A (13)

- Heavy Duty, Grade 1 electronic dual PIN/Prox cylindrical latch (<https://www.gokeyless.com/images/slb.jpg>) lock. Underwriters Laboratory (UL) listed
- Compatible with any HID 125KHZ prox cards 26-48bit
- Rugged clutch mechanism insures long life & durability
- Enrolled users gain access by card only, pin only, or highest security – card plus pin
- Program at lock, or via your laptop or desktop using Windows PC based software; requires [PC interface cables \(https://www.gokeyless.com/product/alarm-lock-al-pci2u-software-kit/\)](https://www.gokeyless.com/product/alarm-lock-al-pci2u-software-kit/) in order to transfer your user data to the lock and download and review your audit trail. (software CD included with purchase of cables, or can be downloaded from Alarm Lock website)

- Desktop PC management requires **DTM-III** (<https://www.gokeyless.com/product/alarm-lock-dtmiii-data-transfer-module/>) to transfer files from your computer to the lock
- **Real-time Clock** lets you scheduled up to 500 timed events, including holiday schedules. Program lock to auto lock at certain times, or auto-unlock. Program times when certain users or groups of users can gain access
- **2000 User Codes/Cards:** Master, manager, supervisor, and basic users
- Program one-time entry codes, quick passage mode, passage mode, emergency and service codes, and lockout codes
- First manager in scheduling – solves the snow day issue for schools (*"First Person In" stops unauthorized persons from gaining access to doors set on timed auto-unlock*)
- Weatherproof performance
- New! **Remote Release Kit** (<https://www.gokeyless.com/product/alarm-lock-rrtrilogykit-remote-release-kit/>) for 'Buzz-In'
- Program allowable entry time from 3-15 seconds – how long user has once they present prox card or pin before door relocks
- Greater security with "Temporary Keypad Lockout" after 3 unsuccessful code-entry attempts
- **Audit Trail;** time/date stamp for a printable record of all electronic activity. Audit trail of key override available in PDL3000K model, custom orders only
- Real-time clock allows logging of events to within 1 second of accuracy
- 4 Time-out functions allow a user to enable other users or unlock the lock for some time period without needing to return to the lock
- Easy to install. Retrofits most **cylindrical** (<https://www.gokeyless.com/images/slb.jpg>) locksets and digital locks
- Choose from multiple **architectural finishes** (<https://www.gokeyless.com/wp-content/uploads/2016/07/trilogyfinishes.gif>)
- Available in standard key override and **interchangeable core** (<https://www.gokeyless.com/IC.htm>) models accepting 6 or 7 pin cores from Arrow, Best, Falcon, or KSP, and removable cores from Schlage, Medeco, Yale, Sargent, Medeco, and Corbin (use your own cores in the lock, or you may order one from us [here](https://www.gokeyless.com/shop/accessories/key-cylinders/) (<https://www.gokeyless.com/shop/accessories/key-cylinders/>)) Best and Schlage IC locks in 26D satin chrome generally ship same day, others may be subject to a lead time
- Backset: 2 3/4" included (2 3/8" available at checkout) [How do I measure?](https://www.gokeyless.com/backset.htm) (<https://www.gokeyless.com/backset.htm>)
- Battery Operation: 5 AA's; appx. 60,000 cycles; low battery alerts
- Red / Black wires – External 7.5 VDC Power Source must be used for operation without batteries
- Audit trail capacity: 40,000 records
- Keypad: All metal, 12 button. All functions programmable through keypad/software. Proximity antenna housing molded of ultra high strength, impact resistant Lexan.
- Warranty: 2 year manufacturer

## AUTHORIZED DEALER

GoKeyless is an authorized dealer for Alarm Lock. It is a highly esteemed role that is not easy to achieve or maintain. It requires great commitment to our customers. This provides many benefits to you including:

- Expert Advice
- Warranty Protection
- Free Basic Training
- Simple Returns



**MONEY BACK  
GUARANTEE**



**FREE GROUND SHIPPING  
ORDERS  
OVER \$97\***



**GREAT CUSTOMER  
SUPPORT**

[SHOP](https://www.gokeyless.com/shop/)

([HTTPS://WWW.GOKEYLESS.COM/SHOP/](https://www.gokeyless.com/shop/))

[MY ACCOUNT](https://www.gokeyless.com/my-account/)

([HTTPS://WWW.GOKEYLESS.COM/MY-ACCOUNT/](https://www.gokeyless.com/my-account/))

[CUSTOMER SERVICE](https://www.gokeyless.com/customer-service/)

([HTTPS://WWW.GOKEYLESS.COM/CUSTOMER-SERVICE/](https://www.gokeyless.com/customer-service/))

[RETURNS](https://www.gokeyless.com/returns/)

([HTTPS://WWW.GOKEYLESS.COM/RETURNS/](https://www.gokeyless.com/returns/))



---

[ABOUT \(HTTPS://WWW.GOKEYLESS.COM/ABOUT/\)](https://www.gokeyless.com/about/), [CONTACT \(HTTPS://WWW.GOKEYLESS.COM/CONTACT/\)](https://www.gokeyless.com/contact/),  
[30 DAY MONEY BACK GUARANTEE \(HTTPS://WWW.GOKEYLESS.COM/30-DAY-MONEY-BACK-GUARANTEE/\)](https://www.gokeyless.com/30-day-money-back-guarantee/),  
[CUSTOMER SERVICE \(HTTPS://WWW.GOKEYLESS.COM/CUSTOMER-SERVICE/\)](https://www.gokeyless.com/customer-service/), [RETURNS \(HTTPS://WWW.GOKEYLESS.COM/RETURNS/\)](https://www.gokeyless.com/returns/),  
[PRIVACY POLICY \(HTTPS://WWW.GOKEYLESS.COM/PRIVACY-POLICY/\)](https://www.gokeyless.com/privacy-policy/), [RAVING FANS \(HTTPS://WWW.GOKEYLESS.COM/RAVING-FANS/\)](https://www.gokeyless.com/raving-fans/),  
[BLOG \(HTTPS://WWW.GOKEYLESS.COM/BLOG/\)](https://www.gokeyless.com/blog/).

© copyright 2018 GoKeyless™



## B. Regulatory Approvals & Compliance

Louie's Gouies Dispensary will be operated in full compliance and consistent with all applicable local and state regulations. We have provided the following discussion on those specific regulations, codes, and policies identified as relevant in the City of Santa Rosa's cannabis application requirements.

### B1. State of California Cannabis Licensing

The State of California began issuing licenses to cannabis businesses in January 2018. The City of Santa Rosa's moniker for our business type "Cannabis Retail (Dispensary) and Delivery", is referred to as a Type 10 Storefront Retailer in the state's Bureau of Cannabis Control (CCR) regulations, Chapter 3, Section §5400, and further defined in BPC section 26070-26070.5.

State regulations require that cannabis for medical or adult-use must be licensed under separate Type M or Type A licenses. Our local delivery-capable dispensary plans to apply for both license types and recognize the restrictions in the supply chain, inventory tracking, and financial reporting that will eventually be flushed out by state law in this area. Our deliveries plan to operate only one location presently with a service area that can expand over time. Licenses are issued for 12 months, requiring annual renewal, and are not transferable. Louie's Gouie's is ready to comply with all state regulations including but not limited to the following list of highlights:

#### § 5400. Access to Retailer Premises

- Our dispensary is applying for both an (A) and (M) license from the state and will be prepared to verify both age by government-issued ID and Medical Use through an established verification system for Medical Recommendations. Only consumers 21 years of age and older will be admitted for purchase of adult-use cannabis or cannabis products and those aged 18 years or older with a valid recommendation for Medical use.

#### § 5401. Limited Access Areas

- Our facility is designed to comply with this section by identifying limited-access areas accessible by only authorized individuals and protected by both security equipment and keycard access for approved personnel of the facility. A log will be maintained of all visitors to the facility who are not employed and who have been verified as being 21 years of age or older. Each visitor will be given a temporary badge and escorted to the authorized area of the facility by a manager or authorized personnel with adequate security clearance. No compensation will ever be considered in exchange for admittance to the facility or restricted-access areas. Company Standard Operating Procedures have been drafted to address this and all other issues of state compliance.

#### § 5402. Retail Area

- The owner or at least one employee will be in either the lobby or sales area with visitors at all times. Individuals will not be granted access to the facility until they have verified their authorization to consume cannabis through presentation of a current and valid government-issued ID or other compliant identification, and a current and valid recommendation from a State-licensed practitioner. Our facility will use a digital verification system that verifies records with the state's online database to ensure proper and complete verification of all visitors entering the facility.



#### **§ 5403. Hours of Operation**

- Louie's Gouie's will maintain hours of operation consistent with local regulations as 9:00am – 9:00pm in preference to the state regulated operation hours of 6:00am to 10:00pm. Changes to operating hours will be in accordance with changes to local governance. During inactive hours, the dispensary will be secured by surveillance and security equipment, alarm and security monitoring in accordance with all regulations and security concerns expressed by state and local governments. We provided our Security Plan along with this application for your complete review.

#### **§ 5404. Retail Customers**

- All retail customers will be verified according to strict age and identification requirements and in compliance with section 5402.

#### **§ 5405. Cannabis Goods Display**

- Any cannabis goods intended for inspection and sale will only be displayed in the retail area and will not be visible from outside the licensed premises. Customer service personnel may remove cannabis from existing containers to a separate container for inspection by the customer and will remain with the customer for the duration of the inspection. Any cannabis product that has been removed from its display will not be sold or consumed and will be destroyed according to section 5054.

#### **§ 5406-5408. Cannabis and Non-Cannabis Goods for Sale**

- Only cannabis goods received from a licensed distributor and verified as not expired and in compliance with all requirements of Business and Professions Code section 26130 and all other relevant laws will be made available for delivery to a verified customer. Although the state has authorized the sale of non-cannabis products under certain circumstances, Louie's Gouie's will adhere to the local regulations prohibiting such sales and will not retail any non-cannabis products, nor will we possess or sell live plants at our facility.

#### **§ 5409-5410 Daily Limits and Customer Returns**

- Louie's Gouie's limits its purchases for any customer to no more than 28.5grams of non-concentrated or 8grams of concentrated cannabis per customer per day. We will comply with all additional state and local regulations and standards pertaining to this section.
- If a customer returns cannabis product, they will be sealed in a designated waste receptacle and disposed of in a manner consistent with our company policies and procedures and compliant with all regulations of section 5410.

#### **§ 5411. Free Cannabis Goods**

- Louie's Gouie's engages from time to time in donations of cannabis under the compassionate use standards of California and will continue to do so in strict compliance with this section. No cannabis will be donated to any person not verified or in possession of the proper authorization and identification. All donated cannabis will be recorded in the track and trace program, be tested, and





compliant with all standards of retail cannabis and will be applied toward the consumer's daily limit upon receipt.

#### **§ 5412-5413. Packaging, Exit Packaging & Labeling**

- Louie's Gouie's will not accept any packaging from a distributor that is not fully compliant with all packaging standards of these sections and other applicable state and local standards for Child and Tamper resistant cannabis packaging.
- All purchased cannabis goods will be placed in opaque exit packaging according to the standards of this section.

#### **§ 5414. Type 9- Non-Storefront Retailer**

- We will conduct retail cannabis sales exclusively by delivery as defined in Business and Professions Code section 26001(p) and in compliance with all the requirements applicable to Type 10-Retailer licensees, except for those provisions related to public access to the premises. In compliance with the Type 9-Non-Storefront Retailer license, the premises will be closed to the public.

#### **§ 5415. Delivery**

- All deliveries of cannabis goods will be performed by our employees.
- All of our employees will be at least 21 years of age.
- All of our deliveries will be made by drivers employed by the company and delivered in a company-owned or approved vehicle.
- We understand that by definition, our delivery process begins when the delivery employee leaves our licensed premises with the cannabis goods for delivery and ends when the delivery employee returns to our licensed premises after delivering the cannabis goods to the consumer(s).
- Our delivery employees will carry a copy of the current company license, their own government-issued identification, and an identification badge provided by us in accordance with state and local regulations during each delivery.
- A current and accurate **Employee Register** of all delivery employees will be maintained on the premises and available for inspection upon request.

#### **§ 5416. Delivery to a Physical Address**

- We will only deliver cannabis goods to a physical address in California.
- Our delivery employee will not leave the State of California while possessing cannabis goods during their shift.
- We will not deliver cannabis goods to an address located on publicly owned land or any address on land or in a building leased by a public agency, including land held in trust by the United States for a tribe or an individual tribal member, unless the delivery is authorized by and consistent with applicable tribal law.

#### **§ 5417. Methods of Delivery**

- Cannabis goods intended for delivery will be conveyed by our employees in an enclosed motor vehicle.
- Our delivery employees will not allow cannabis goods to be visible to the public during transfer to the delivery location.
- Our delivery employees will be trained in adequate safety measures according to standard policies and procedures. No delivery employee will leave cannabis goods in an unattended motor vehicle unless the motor vehicle is locked and equipped with an active vehicle alarm system.
- Vehicles used for the delivery of cannabis goods will be outfitted with a dedicated Global Positioning System (GPS) device which is owned and operated by the licensee. The GPS system will have the capability of identifying the geographic location of all vehicles owned and used exclusively by our companies for delivery. Tracking devices will be either permanently or temporarily affixed to each delivery vehicle and will remain active and inside the delivery vehicle at all times during delivery. Each delivery is equipped to respond quickly and accurately should the Bureau of Cannabis Control request tracking information pertaining to the location of any of our delivery's vehicles at any time.
- Upon request, we will provide the Bureau with information regarding any motor vehicles used for the delivery of cannabis goods, including the vehicle's make, model, color, Vehicle Identification Number, license plate number and Department of Motor Vehicle's registration information.
- We understand that impromptu vehicle inspections may be required by the bureau at the licensed premises or during delivery. To this end, facility staff and drivers are prepared per company policy, to comply with all such requests by the bureau.

#### **§ 5418. Cannabis Goods Carried During Delivery**

- At no time during delivery will our employees carry cannabis goods worth more than \$3,000. Company policy requires management staff to review with each driver, the contents of their inventory case, and a checklist of items the driver should have for the delivery route prior to each delivery. Value shall be determined using the current retail price of all cannabis goods conveyed during delivery.

#### **§ 5419. Cannabis Consumption During Delivery**

- In accordance with state and local regulations, as well as our standard company policy, our delivery employees are prohibited from consuming cannabis goods while either on the premises or in the process of delivering cannabis goods to consumers.

#### **§ 5420. Delivery Request Receipt**

- We will comply with all regulations in the preparation of a delivery request receipt for each delivery transaction. Each receipt will contain the following:
  - The name and address of the retailer;
  - The first name and company-issued identification number of the employee who delivered the order;
  - The first name and company-issued identification number of the employee who prepared the order for delivery;
  - The first name of the consumer and a retailer-assigned consumer number for the person who requested the delivery;

- The date and time the delivery request was made;
- The delivery address;
- A detailed description of all cannabis goods requested for delivery. The description will include the weight, volume, or any other accurate measure of the amount of all requested items;
- The total amount paid for the delivery, including any taxes, fees, the cost of the cannabis goods, and any other charges related to the delivery;
- The date and time the delivery was made, and the signature of the consumer who received the delivery;
- After the consumer has signed for delivery, our delivery employee will provide them with a copy of the delivery request receipt, retaining the original for company records.

#### **§ 5421. Delivery Route**

- While making deliveries of cannabis goods, our employees are instructed to travel only from the licensed premises to the delivery address; from one delivery address to another delivery address; or from a delivery address back to the licensed premises. Our delivery employees will not deviate from the delivery path described, except for necessary rest, fuel, or vehicle repair stops, or because road conditions make continued use of the route unsafe, impossible, or impracticable.

#### **§ 5422. Receiving Shipments of Inventory**

- In compliance with state regulations and company policy, our shipments of cannabis goods for inventory will be received only from a licensed distributor.
- Any shipments of cannabis goods will be received only between the hours of 6:00 a.m. to 10:00 p.m. Pacific Time.
- During business hours, shipments of cannabis goods will not enter the premises through an entrance or exit that is available for use by the public.

#### **§ 5423. Inventory Documentation**

- Our companies will maintain a current and accurate record of inventory which will track cannabis goods both on the premises and out for delivery at all times. Upon request, we are prepared to furnish records of inventory to the Bureau. The following list of information will be kept for each inventory item:
  - An easily identifiable description of each inventory item;
  - An accurate measurement of the quantity of the item;
  - The date and time the cannabis goods were received by the retailer;
  - The sell-by or expiration date on any cannabis goods, if any;
  - The name and license number of the licensee that delivered the cannabis goods to the retailer;
  - The name and license number of the distributor that provided the cannabis goods to the retailer;
  - The price the retailer paid for the cannabis goods, including taxes, delivery costs, or any other costs;

#### **§ 5424. Inventory Reconciliation**



- In compliance with state regulations, our delivery businesses will implement the following steps to ensure adequate inventory tracking:
  - A reconciliation of inventory will be performed by a company manager on a bi-weekly basis.
  - The inventory manager will verify that the physical inventory matches the facility's inventory records.
  - All records of inventory reconciliation will be maintained on site and available to the Bureau upon request.
  - If any evidence of theft, diversion or loss is identified, the inventory manager will notify the Bureau and law enforcement in accordance with Section § 5036 of the CCR.
  - If a significant discrepancy as defined in Section § 5034 of the CCR is discovered between our company's physical inventory and the inventory records, our inventory manager will notify the Bureau and law enforcement in accordance with Section § 5036 of the CCR.

## B2. County and Regional Permits

Louie's Gouie's will obtain a Sonoma County Health permit, if applicable, and comply with Health and Safety Code Section 13700 et seq. and Sonoma County Health permit requirements in order to sell retail edible cannabis products at our dispensary.

## B3. City of Santa Rosa General Plan

The proposed dispensary is in line with the City of Santa Rosa's General plan as we seek to preserve the existing building and improve the grounds to create a business that is easily accessible by local pedestrian traffic. The General plan states its desire to promote the use of alternative transportation modes and discourage travel by automobile which is one of the positive benefits that the improvements to the grounds of 316 Yolanda will provide the city. Additionally, Louie's Gouie's operation will support the general plan in all of the following ways:

- Landscaping and improvements – the improvements to the premises around the dispensary will promote the quiet and safe flow of traffic and a higher degree of visual transparency enhancing the safety of the area;
- Connections – our local dispensary will enhance the connectedness of the local area by adding a valuable service that will be accessible to a wide variety of authorized clientele and add to the neighborhood character;
- Preservation of natural features – by preserving the existing and mature trees around the lot and removing unsightly sheds, vehicles, fences and ground cover, our operation will greatly improve the aesthetics of the area while preserving the home and existing natural features of the site;
- Diversity and Choice – Our dispensary will also contribute to the City's desire to create choice for residents with different values by offering a variety of products that suit the needs of a wide range of customers.
- Our proposed site is less than a quarter mile from the nearest public transportation stop and within walking distance of several food and retail stores.

## B4. City of Santa Rosa Municipal Code

Louie's Gouie's is proposing to locate its operations in a newly remodeled dispensary at 316 Yolanda Avenue in the City of Santa Rosa. Our secured premises, developed to accommodate the expected workflow that will be guided by our policies and procedures currently under development, are designed



to comply with all rules and regulations specified by state and local agencies. Louie's Gouie's intends to successfully acquire and maintain its licensure in good standing and to demonstrate the Company's commitment to exemplary compliance.

As a cannabis-based business, we intend to align with Ordinance No. 2017-025 of the Council of the City of Santa Rosa Costa relating to Licenses and business Regulations. Chapter VI governs cannabis businesses lawfully operating in the City of Santa Rosa and as such, we are here giving special focus to, Ch VI., Section 20-46.080, Cannabis Retail (Dispensary) and Delivery to demonstrate Louie's Gouie's intentions to comply.

20-46.010. Purpose and intent.

- We recognize the right and responsibility of the City of Santa Rosa to protect the health, safety, and welfare of its residents in general and specifically with regard to the marijuana or cannabis industry and products, and to enforce rules and regulations consistent with state law. In acknowledgment of this right and responsibility, Louie's Gouie's respectfully seeks a permit to operate a medical marijuana business within the city.

20-46.020. Limitations on Use

- Louie's Gouie's will comply with Resolution 2017-035 and the accompanying Cannabis Industry Tax Ordinance by submitting the required sworn statement and paying the annual fees in connection with registration of a Cannabis Business. In addition, Louie's Gouie's will remit the required quarterly taxes of 3% for its Adult Use retail sales and 0% for its Medical retail sales and comply with all applicable reporting and compliance standards set forth in the resolution and ordinance. Louie's Gouie's pledges to remain in consistent compliance with all State and Local regulations governing the sale and distribution of cannabis.

20-46.040. Cannabis Businesses

- Louie's Gouie's is located in a commercially zoned area with no nearby school or other sensitive use locations within a 600' radius. Land Use and Developmental standards outlined in Divisions 2 & 3 of the Site Planning and General Development Regulations along with the City Code will be adhered to completely unless a conflict between the requirements of Chapter VI - Cannabis, and those of Divisions 2 & 3 arises. In the case of such a conflict, Chapter VI stipulations will control.

20-46.050. General Operating Requirements

*Dual Licensing & Permitting Requirements*

- Louie's Gouie's intends to comply with all requirements outlined by the state and local governments including dual state and local permitting. We intend to apply for a state Medical Use (M) and Adult Use (A) permit in connection with the approval of our Conditional Use Permit request as an Operator in good standing.
- In addition to state and local licensing, the operation will obtain all required permits including Building and Fire permits confirmed with the appropriate occupancy classification and in compliance with Chapter 18 of the City Code. All annual operating fire permits will be obtained prior to the commencement of operations. The dispensary will comply with all applicable H&SC and California Fire Code requirements related to storage, use and handling of hazardous materials and generated hazardous waste and will obtain all additional required permits prior to opening. The local Fire Department will be provided with a lockbox for keys to all gates and doors.



- Louie's Gouie's does not intend to transfer dispensary ownership but in the event of such occurrence, will follow all required processes including the acquisition of a zoning clearance.
- As Louie's Gouie's does plan to maintain dual state licensing for the retail and delivery of both Medical (M) and Adult Use (A) Cannabis products, we have designated a clear separation within our retail sales and storage areas for the classification of Medical and Adult Use products. Inventory tracking procedures will handle (M) and (A) products as separate inventory databases

#### *Compliance with Laws & Prohibition of Minors*

- We recognize our responsibility to ensure that we are always operating in a manner compliant with all applicable state and local laws, and any regulations promulgated thereunder. Specifically, as it applies to minors, our operation is committed to ensuring the prohibition of minors on or around our premises. A person is considered a minor if they are under the age of 18 years and do not have a valid, state issued Medical Cannabis card or, if they are under the age of 21 years and not authorized to consume Medical Cannabis.

#### *Security measures.*

- We will implement sufficient security measures to deter and prevent the entrance of unauthorized persons into areas containing medical cannabis or medical cannabis products, and to deter and prevent the theft of medical cannabis or medical cannabis products at the medical marijuana business. These security measures include:
  - Establishing limited-access areas accessible only to authorized personnel or escorted visitors over the age of 21;
  - Storing all medical cannabis and medical cannabis products in a secured and locked room, safe, or vault in a manner that prevents diversion, theft, and loss;
  - Installing sensors and Building Code compliant commercial-grade, non-residential door or window locks on all points of ingress and egress to detect and/or prevent entry and exit;
  - Having a professionally installed, maintained, and monitored alarm system;
  - Having security bars on the windows or the doors, as needed only on the interior of the building;
  - Ensuring that any security personnel utilized will be licensed by the State of California Bureau of Security and Investigative Services Personnel; and
  - Maintaining the capability to remain secure and operational during a power outage and ensuring that the integrity of all access doors and electronic locks remains.
  - Implementing Standard Operating Procedures for safe and secure transportation and delivery of Cannabis, Cannabis Products and currency in accordance with state law.
  - Establishing best management practices and technologies for reducing glare, light pollution and light trespass onto adjacent properties. Exterior lighting will provide illumination and clear visibility to all outdoor areas of the premises including all points of ingress and egress. The operation will comply with all additional requirements of Chapter VI, Section 20-46.050 with regard to both exterior and interior lighting.
- We identify Louie's Gouie's Owner Luis Chavez, as the designated security representative/liaison to the City. Luis will be reasonably available to meet with the city's CEO regarding any security related measures or operational issues.
- The Louie's Gouie's Owner will be notified within twenty-four (24) hours of the discovery of any of the following:





- Significant discrepancies identified during inventory, as set forth in the city's administrative regulations;
- Diversion, theft, loss, or any criminal activity involving Louie's Gouie's or any agent or employee of our business; or
- The loss or unauthorized alteration of Louie's Gouie's records related to cannabis, cannabis products, or employees or agents of our business.

#### *Records and recordkeeping.*

- Louie's Gouie's intends to implement and maintain a state-compliant inventory control and reporting system that accurately documents the present location, amounts, and descriptions of all cannabis and cannabis products for all stages of the production or manufacturing, laboratory testing and distribution processes.
  - Subject to any restrictions under the Health Insurance Portability and Accountability Act (HIPPA), we will allow city officials to have access to our business's books, records, and accounts, together with any other data or documents relevant to our permitted medical marijuana activities, for the purpose of conducting an audit or examination. This information will be produced no later than twenty-four (24) hours after receipt of the city's request, unless otherwise stipulated by the city.
- We will maintain accurate accounting records, detailing all revenues and expenses of the business and all of its assets and liabilities. At least annually, (at or before the time of the renewal of a medical marijuana business permit issued pursuant to this title), or at any time upon reasonable request of the city, we will file a sworn statement detailing our number of sales per month during the previous twelve (12) month period (or shorter period based upon the timing of the request).
- We will establish and maintain an Employee register which contains the names, numbers and personal identification information such as, date of birth SSN and Vehicle Operating Licenses for each employee hired by Louie's Gouie's. Recording standards and file contents are discussed further in the Employment & Hiring practices of this Narrative;
- Felons will not be considered for employment by Louie's Gouie's and such applicant files as well as files of terminated employees will be maintained by the Human Resources manager who will establish a routinely updated list for the Security staff. This list will act as a reference list for security personnel and will be referred to each time a visitor or consumer is verified for entry to the premises;
- We will maintain and provide upon request, a current Employee Register, complete contact information (name, address, and telephone number), of anyone owning or holding an interest in Louie's Gouie's, and separately of all the officers, managers, employees, agents and volunteers currently employed or otherwise engaged by our business.

#### *Odor Control*

- We will incorporate odor control devices and techniques to ensure that odors from marijuana are not detectable off-site. Please refer to our Odor Control Plan.

#### *Noise*

- Louie's Gouie's will use only compliant ventilation and A/C equipment in accordance with the Chapter 17-16, Noise. Our operation will only use generators temporarily in the event of a permitted emergency to back up security and safety features of the facility as well as temporarily run our financial systems. Given the nature of our business as a retail operation, we anticipate our building noise to be lower than the ambient noise from Yolanda Avenue and the surrounding industrial buildings, including those between our business and nearby residential units to the south.



#### *20-46.080 Cannabis Retail (Dispensary) and Delivery*

- Louie's Gouie's is applying for the required Conditional Use and other required permits to operate a Cannabis Retail Dispensary at 316 Yolanda Avenue in the City of Santa Rosa. This dispensary is applying for both an M (Medical Use) and A (Adult Use) license from the State and a Commercial Retail and Delivery Service permit from the City of Santa Rosa.
- Louie's Gouie's intends to operate as a secured storefront dispensary with a permitted delivery service to provide a wider range of care for local cannabis users who are immobile or otherwise unable to go to a local dispensary. No walkup or drive-through services will be provided. A detailed description of our operations can be found in Section 5 of this Narrative.
- We have verified through certified professionals that our chosen dispensary location is not within 600' of recognized sensitive areas such as schools. The City has acknowledged the presence of two additional retail applicants within a 300' range of our intended operation and as such, we intend to demonstrate throughout this application, the value that we will provide the City and the local community over and above our competitors.
- The entrance to our storefront will be in a visible location, facing the street with unobstructed views from the public right of way as per City regulations.
- Louie's Gouie's will obtain a Sonoma County Health permit, if applicable, and comply with Health and Safety Code Section 13700 et seq. and Sonoma County Health permit requirements in order to sell retail edible cannabis products at our dispensary.

#### *Operational Requirements*

Louie's Gouies will comply with all stated operational requirements both in the state and local standards of the City of Santa Rosa including but not limited to:

- We will maintain adequate and complete records of sales, inventory, human resources (Employee Register), maintenance, security and any other records required by the City and will provide copies to the City or other authorized officials upon request and within assigned timeframes.
- We will have in place a point-of-sale or other inventory tracking and invoicing system to monitor and report on all aspects of our business including, but not limited to, such matters as cannabis tracking, inventory data, and gross sales (by weight and by sale). We will ensure that such information is compatible with the city's record-keeping systems and has the capability to produce historical transactional data for review by the city's CEO.
- We will have protocols in place to verify the identification of all staff and visitors that enter the premises. Persons under the legal age of consumption for medical or adult-use cannabis will not be allowed on site. Legal age will be verified by government issued photo identification and Medical recommendation for Medical users. No cannabis or cannabis products will be provided to persons not in possession of a valid government-issued photo identification card and where required, a valid physician's recommendation under Section 11362.712 of the Health and Safety Code.
- Our facility will run in compliance with the City of Santa Rosa's requirements, from the hours of 9:00am to 9:00pm seven (7) days a week unless the review authority imposes more restrictive hours due to particular circumstances of the application.
- Our facility will have established secured-access areas, accessible by keycard assigned to only authorized personnel. All products not used for display or immediate sale will be stored in a secured and locked room, safe, or vault within the limited-access area which is designed to prevent diversion, theft and loss.

- Any cannabis and cannabis products that are sold, distributed, or manufactured by our operation will be cultivated, manufactured, and transported by licensed businesses that maintain operations in full conformance with the state and local regulations. No cannabis related paraphernalia or any implement used to administer cannabis will be sold at our dispensary per City zoning codes and conditions of the CUP.
- Our site will be maintained according to strict operating policies and procedures in compliance with state regulations for site management including but not limited to; maintenance of exterior, mitigation of nuisances on premises and in parking and surrounding areas; and implementation of an emergency plan for contacting police or security.
- Louie's Gouie's does not intend to allow onsite cannabis consumption by employees or patients as permitted in Chapter 9-20 (Smoking Regulations). As such, we will prohibit consumption of cannabis products on our facility premises and by our employees elsewhere in the City through onsite signage and strict adherence to company policies and procedures.
- We will visibly post at each entrance, a clear and legible notice indicating that smoking, ingesting, or otherwise consuming cannabis on the premises or in the areas adjacent to the medical marijuana business is prohibited. We will not implement any business identification signage that fails to conform to the requirements of the city's code.
- Any signage we use will be limited to that needed for identification only.
- We will not allow cannabis or cannabis products or graphics depicting cannabis or cannabis products to be visible from the exterior of our property or on any of our vehicles owned or used as part of the business. We will not store any cannabis or cannabis products outside.
- We will post the original copy of our city-issued medical marijuana business permit and business license inside our business in a conspicuous location.
- We will ensure that every owner, manager, supervisor, or employee of our business submits fingerprints and other information deemed necessary by the city's CEO for a background check by the Santa Rosa Police Department, to verify that person's criminal history.
- Loitering outside of the facility by any person, either on the premises, or within fifty (50) feet of the premises, is prohibited.
- We will not cause or permit the sale, dispensing, or consumption of alcoholic beverages on or about our premises.

*Insurance.*

- We will obtain and maintain at all times during the term of the permit, comprehensive general liability insurance and comprehensive automotive liability insurance protecting us in an amount of not less than one million dollars (\$1,000,000.00) per occurrence, combined single limit, including bodily injury and property damage; and not less than one million dollars (\$1,000,000.00) aggregate for each personal injury liability, products completed operations and each accident, issued by an insurance provider admitted and authorized to do business in California and rated at least A:X in A.M. Best and Company's Insurance Guide.

20.46-090 Cannabis Special Events

- Louie's Gouie's does not intend to hold or apply for any special events as a function of its operation.

20-70.020 Section 7, Definitions

- This application and all of our materials and Standard Operating procedures are written in compliance with the current definitions outlined in the above-referenced Section of the City Code.



#### 20.46-100 Acknowledgement of Grounds for Permit Revocation or Modification

- Louie's Gouie's additionally acknowledges that our permit can be revoked upon a hearing by the city for failing to comply with the terms of the permit, the applicable provisions of city ordinances, state law or regulation and/or any condition of any other permit issued pursuant to this code, and such revocation will preclude us from operating until the matter is resolved.

#### Section 8 – Environmental Determination

- We recognize the stipulations adopted by the Council exempting ORD-2017-025 from CEQA review in certain circumstances not including the application for Conditional Use. Our present application will include all environmental considerations in more detail in the sections below to demonstrate our compliance with all requirements. We anticipate our project being categorically exempt under CEQA for minor land use modifications and other categories deemed appropriate by the City.

#### B5. Santa Rosa City Building and Fire Code

Our project is committed to following all applicable fire and building codes, including the following:

- California Building Code (2016 Edition)
  - Our improvements will include modify internal walls, exterior ADA ramp and railings, and other features. When applicable, we will apply for a building permit.
- California Plumbing Code (2016 Edition)
  - As a part of converting the building from its previous residential use, we will update the bathrooms to be compliant with ADA accessibility. All new fixtures will adhere to current Plumbing Code.
- California Electrical Code (2016 Edition)
  - When applicable, we will apply for a building permit for any electrical changes required to improve our property. This includes exterior lighting used for safety and security.
- California Mechanical Code (2016 Edition)
  - Our ventilation system will be updated to state of the art components, all of which will be in compliance with this code.
- California Fire Code (2016 Edition)
  - Per current fire code, we will install sprinklers in our building and otherwise comply with this code.
- 2016 Building Energy Efficiency Standards for Residential and Non-Residential Building
  - We intend to improve our building with energy efficient features to reduce unnecessary heat and light loss. All improvements will be in compliance with current Title 24 energy efficiency standards.
- Americans with Disabilities Act (ADA) Compliance
  - Our building conversion to a commercial use will include all necessary improvements to be compliant with ADA, including properly sized hallways, door levers, threshold standards, ramp and railing improvements, and unobstructed path of travel to and from our ADA compliant parking lot.
- All codes adopted with local amendments per City of Santa Rosa ordinances



- As new ordinances modify local codes, we will be sure to stay in compliance where applicable.

#### B6. Licensing Maintenance

As state cannabis licensees, we are prepared to submit an annual renewal to remain active. We are also prepared to comply with unscheduled inspections and all state requirements for standard operating procedures (SOP).

#### B7. Substantially Related Offenses Review

None of our business owners have ever committed any substantially related offenses, such as felony convictions, that could hinder approval of our application. We have supplied the City with the required driver's license information in compliance with the LiveScan review process. This information has also been supplied to the state. Any updates will be furnished to both state and local governments in compliance with regulations.

#### B8. Labor Peace Agreement

The State of California requires all cannabis licensees to execute a Labor Peace Agreement with a local union if the licensee employs 20 or more employees. Should any of our respective businesses employ more than 20 individuals, we are prepared to engage a local labor union per requirements. Employees of each company will receive fair wages and, as conditions become appropriate, will be allowed to join a union of their choosing.

#### B9. California Environmental Quality Act

All public agencies in California are required by the California Environmental Quality Act (CEQA) to conduct an environmental assessment of any action they make that has the potential for resulting in a physical change to the environment.



## C. Neighborhood Compatibility

### C1. Use of Premises in Providing Stability, Quality and Support – Compatibility:

As long-time Santa Rosa residents, our business owners recognize and understand the importance of ensuring the compatibility of the business with the surrounding community. We will take all of the steps necessary to meet and exceed the City's expectations for cannabis dispensaries to help contribute to the stability and quality of the surrounding neighborhood.

#### **Parking and transportation**

The property redesign will include a rear parking lot containing 6 parking stalls and a front parking area with 1 ADA accessible space. The City of Santa Rosa parking regulations require one (1) space for every 250 square feet of retail dispensary space. Our proposed building is 1,395 square feet in size including utility areas and requires 6 parking spaces ( $1,395 / 250 = 6$  parking spaces) to be compliant with city code. The City also requires 1 bicycle parking space for every 5,000 square feet of retail space, which our redesigned site will include. This will help to encourage alternative transportation methods by providing customers choosing to bike to the business a place to secure their bicycles outside.

Louie's Gouie's has prepared a draft manual of Standard Operating Procedures which detail the company standards that will be implemented to manage patient and traffic flow to the site. We know that when each person understands their role and duties, workflow and operations run more smoothly and efficiently. While we do not anticipate periods of heavy traffic where our parking area may be at capacity, we propose the following mitigation measures to ensure that traffic does not become an issue with our neighbors:

- **Public transit and ride-share** – Our dispensary will offer discounts to customers and monthly stipends to employees who travel to our dispensary by public transit, carpooling, or ride-share solutions such as taxi, Lyft, or Uber. We are convinced that both customers and employees alike will take advantage of our incentives to save money. In addition to reducing vehicular traffic on and around our property, this solution will also have the added benefit of encouraging more pedestrian traffic along the commercial corridor which will in turn increase safety through more eyes on the street and potential economic benefits to nearby businesses.
- **Security personnel directing traffic** – Louie's Gouie's will employ security personnel to monitor our property during business hours. These individuals will be instructed to:
  1. Prevent crime and loitering;
  2. Ensure the premises stays clean, organized, and free of trash; and
  3. Direct and manage traffic to ensure our parking lot does not end up over capacity and that patrons attempting to enter when the lot is full do not create a parking queue along our vehicle access driveway.
- **Cannabis Retail Delivery** – Our cannabis dispensary business model includes a delivery component to service our patrons who have limited mobility or are too ill to travel to our location. In addition, other customers find delivery a more convenient or discrete way to obtain cannabis products either for medical or recreational uses. Given that one delivery driver can service 10-15 customers per day, with our goal of employing up to 10 drivers, our delivery service will reduce





the number of vehicle trips to our business location by up to 140 trips per day after subtracting our drivers. Less customers driving to our business location provides the following benefits:

1. Reduces vehicle miles on city streets with efficient driver routes which will have a positive effect on air quality;
2. Reduces traffic and the likelihood our neighborhood is significantly impacted during peak hours;
3. Reduces the amount of activity, making it easier for our security personnel to monitor our property and keep it clean;
4. Allows us to scale our business in the future without also scaling potential impacts.

### **Safety and Security**

In compliance with local and state regulation, Louie's Gouies will utilize various safety and security measures outlined in our Security Plan and Fire Suppression and Safety Plan to ensure the protection of our business and deter crime in the neighborhood.

Dispensary patron access to the sales area will be controlled and limited with an electronic access door. Employees will only be allowed to enter the property at specific times. All visitors will be properly screened via walk through or hand-held metal detector and age-verified through an online verification system.

The dispensary will utilize a video surveillance system installed by a licensed third-party security company and monitored both offsite and locally in the security office on the premises. Cameras will be placed inside and outside the building to ensure all areas outlined by the regulatory bodies are under camera coverage. The cameras will be clearly seen during the day and the infrared lights will be clearly seen at night from all outside areas.

The dispensary will also feature an alarm system that is activated at all times the business is closed. The system will detect unauthorized entrance at all entry or exit points, and all exterior windows of the premises. It will also detect movement in the licensed premise when the premise is vacant of employees.

In the event of security breach, local law enforcement will be contacted and dispatched if necessary. The Security Manager will oversee and ensure that the alarm system, video monitoring, and all other security components are in proper working order, and that the system is periodically tested and verified.

### **Nuisance Management**

While cannabis products will be packaged and sealed in tamper-proof packaging when it arrives at the property from a licensed distributor, a small amount of odor is anticipated. Louie's Gouies intends to mitigate for any potential odor through the means described in our Odor Control Plan. The dispensary will utilize industrial-grade odor neutralizers for the interior of the business, and all air from the building will be exhausted through a filtration system that scrubs any cannabis odor ensuring that neighbors and the community will not be able to detect any difference from currently present ambient odors.

The property will include exterior lighting systems for security purposes to provide illumination and clear visibility to all outdoor areas of the premises, including all points of ingress and egress. All exterior lighting will be stationary, fully shielded, directed away from adjacent properties and public rights of way, and of an intensity compatible with the neighborhood. The proposed site redesign will feature trees and plants



that will help shield exterior lighting from adjacent properties. All exterior lighting will be compliant with building codes and with Section 20-30.080 of the City's Outdoor Lighting Ordinance. Interior lighting systems will also be fully shielded, including shades or curtains on all windows to confine light and glare to the interior of the building.

All air conditioning and ventilation equipment will comply with the City's Noise Ordinance (City Code, Chapter 17-16). Trees and plants as well as fencing on the redesigned property will help to reduce noise transmittance from the building to adjacent properties.

The property conforms to the 600-foot minimum setback requirement to a school. In addition, we will ensure that all advertising and marketing efforts are in compliance with City ordinance requirements (keeping all materials 1,000 feet from day care centers, schools, playgrounds, and youth centers) and state regulations restricting advertising to our adult customer audience.

## C2. Odor Control

The City of Santa Rosa is concerned with controlling cannabis odor, which is pungent and can cause a nuisance to neighbors as well as attract unwanted persons. While cannabis products will be packaged and sealed in tamper-proof packaging when it arrives at the property from a licensed distributor, a small amount of odor is anticipated. Louie's Gouie's intends to mitigate for any potential odor through the means described in the attached, Engineer Certified, Odor Control Plan.

## C3. Enhanced Retail Experience

### Site Improvements

From the perspective of the neighborhood, the future location of Louie's Gouies is currently an unoccupied residential structure. The business owners have already taken steps to improve the façade of the structure and have developed a proposed redesign of the site to provide an attractive location for the dispensary. Exterior improvements will benefit the immediate premises and the surrounding area by trimming and updating existing landscaping on the expansive grounds, removing fences, barbed wire and trash, and improving the aesthetics of the area through these efforts. Our use of the existing mature trees to accentuate improved parking areas We wish to create and inviting atmosphere that resonates a sense of safety and welcoming community spirit.

The new proposed look includes improvements to the building's front façade, with added parking areas, ramp access to the building, and enhanced landscaping. We plan to use insulated and security reinforced windows and doors to protect the premises and deter trespassing. To convey the proper level of safety and professionalism, the exterior of our facility will be monitored for litter and debris on a daily basis by our patrolling personnel. Routine landscape services will ensure an attractive building exterior and our plans to participate in and lead neighborhood clean-up efforts will improve the community effect on the whole.

Upon approval, our team will provide a single sign in compliance with city guidelines. We will not advertise or market the business through any signage within 1,000 feet of a day care center, school, playground, or youth center.



All of our business activities will be conducted within the interior of the secured and monitored facility. The dispensary show room, secured storage, and offices will be located behind an interior curtain wall, only accessible to verified visitors and staff. During business operating hours, onsite security personnel will regularly patrol the front entrance and parking lot. After business hours, all doors and windows will auto-lock and will be checked by security prior to leaving the premises.

### **Product Enhancement**

Our owner Luis Chavez has a flair for learning a subject and improving upon the existing template to create enhanced business, products and services. Louie's Gouie's dispensary is no different and the owners have worked hard to ensure that their products are enhanced above and beyond competitors to provide the most effective products to cannabis consumers throughout the community.

#### *Product Storage & Handling Controls*

All products in the Louie's Gouie's inventory for resale and delivery will be stored and handled according to the company's safety and best practices. Products will be stored in designated high-security areas with limited access. Limited-access areas will be restricted to entry by only authorized personnel per company policy (See the Draft SOP Manual, Attached).

Manual and digital tracking systems allow constant monitoring of inventory including an exact count and listing of available products in real-time. Inventory will be routinely audited bi-weekly per our company's standard procedure and may be audited at additional intervals per the discretion of management staff. Our policies and procedures include standards for entry of all inventory into the state's Track-And-Trace system. Through various inventory and tracking procedures, we can know the location of every product whether in transit to a delivery or retained on the premises.

#### *Child Resistant Packaging*

In compliance with state law and our commitment to social responsibility, we will ensure that every package containing cannabis that is delivered by our company, will be either placed in a Child Resistant (CR) outer package such as an opaque, sealed bag and/or sealed in a Child Resistant container. Inventory products for resale and delivery will be purchased from only licensed distributors that have certified their products as CR.

In addition to the specifications above, Child Resistant packaging used by our service will adhere to the following requirements:

- The package will protect the product from contamination and will not expose the product to any toxic or harmful substance;
- The package will be tamper-evident, which means that the product will be contained in packaging that is sealed so that the contents cannot be opened without obvious destruction of the seal;
- The package will be child-resistant, which means it will be designed or constructed to be significantly difficult for children under five years of age to open or otherwise obtain access to the contents within a reasonable time but will not be difficult for normal adults to open or access the products inside. A package will be considered child-resistant if it satisfies the standard for "special



packaging” as set forth in the Poison Prevention Packaging Act of 1970 Regulations (16 C.F.R. §1700.a(b)(4))

- Packages containing multiple servings will be resealable to maintain CR throughout the life of the package.

#### *Not Attractive to Children*

The safety of children who may be exposed in some way to cannabis product packaging is paramount to our company and the community at large. State and local regulations assist us in this effort by providing guidelines for company policies. It is our policy that no container will imitate any packaging or labeling used for products typically marketed to children, such as brightly-colored candy.

#### *Properly Labeled*

Packaging and labeling standards have been prepared to comply with requirements specified by the Bureau of Cannabis Control, Section 5412, and California Business and Professions Code section 26120 to ensure our company’s consistent compliance across both A and M license regulations. Standards are reviewed regularly to stay current with the changing and growing industry.

Examples of specific labeling requirements that may be highlighted here are as follows:

- The label will include an information panel containing – The name and contact information of the licensed manufacturer and the date of manufacture;
- For packages delivered under “M” licensure, the following warning will be included along with potency, strain and testing information:

“GOVERNMENT WARNING: “THIS PRODUCT CONTAINS CANNABIS, A SCHEDULE I CONTROLLED SUBSTANCE. KEEP OUT OF REACH OF CHILDREN AND ANIMALS. CANNABIS PRODUCTS MAY ONLY BE POSSESSED OR CONSUMED BY PERSONS 21 YEARS OF AGE OR OLDER UNLESS THE PERSON IS A QUALIFIED PATIENT. THE INTOXICATING EFFECTS OF CANNABIS PRODUCTS MAY BE DELAYED UP TO TWO HOURS. CANNABIS USE WHILE PREGNANT OR BREASTFEEDING MAY BE HARMFUL. CONSUMPTION OF CANNABIS PRODUCTS IMPAIRS YOUR ABILITY TO DRIVE AND OPERATE MACHINERY. PLEASE USE EXTREME CAUTION.”

## D. Clear and Attractive Entrance, Pedestrian Orientation, Bike Parking & Access to Transit

### **Proposed Property Improvements**

Our proposal is to completely rehabilitate the property, which would include the following improvements (Please refer to architectural plans for improvement specifications):

- Exterior Improvements
  - Installation of attractive landscaping in the front and rear yards, particularly along the street
  - Removal of all dilapidated fencing
  - Removal of all wood sheds in the back yard
  - Installation of a 6-space rear parking lot and an ADA parking space in the front yard

- Installation of security lights in the front and rear of the property in compliance with the City's lighting ordinance
- Installation of walkways in the front and rear yards
- ADA accessible ramp improvements with a railing at the front entrance
- Upgraded windows (inserts) for the entire existing building
- Exterior painting and trim
- Interior Improvements
  - Relocation of interior walls
  - Installation of laminate flooring
  - Installation of granite countertops
  - Interior painting and trim
  - ADA improvements to both bathrooms
  - Installation of restricted access security doors
  - Installation of security and surveillance equipment
  - Installation of retail showroom cabinets
  - Installation of security window in lobby

The goal of our improvements will be twofold. First we want to demonstrate to our neighbors how a legal retail dispensary should look and operate. Once we are in operation, they will begin to understand that our retail establishment is no different than the adjacent retail complex that includes Subway, Starbucks, and several other businesses. Additionally, they will be impressed by how our property improvements, maintenance, security personnel, surveillance, and adherence to good standard operating procedures actually improves the area far beyond a typical retail store. In fact, recent studies from Colorado and other parts of California have determined that in contrast to previous beliefs, properly run cannabis dispensaries actually increase property values, safety, and significantly increase profitability of nearby businesses as our patrons are more likely to make other purchases while in the area. Additionally, they will see that inclusion of our delivery service helps greatly to moderate vehicular traffic activity and our incentive program for mass transit and shared ride users increases pedestrians on the streets.

#### *Exterior*

Second, we want to create an excellent user experience for our customers starting with maintaining a clean exterior parking lot and entryway. Our front entry is approximately 40 feet from the existing road. Our walkways, ADA accessible ramp, and entryways will all be improved to current commercial building code, including the addition of a railing to the front entry ramp. As per our architectural plans, the railings, tread, slope, door handles, and thresholds will be compliant with California and City building codes, as well as ADA standards. Per our lighting plan, all parking areas and building entries will be illuminated with City code compliant lighting that improves security and visibility on the property while shielding light pollution that may otherwise cause a nuisance. We have already started the process of replacing the existing windows with new and attractive double-pane windows. We plan to repaint the entire exterior including trim, which will provide our building with a much-needed face lift. All entry doors will be replaced with high-quality security doors that prevent any potential robberies but are also attractive.

#### *Parking Analysis*

The property redesign will include a rear parking lot containing 6 parking stalls and a front parking area with 1 ADA accessible space. The City of Santa Rosa parking regulations require one (1) space for every 250 square feet of retail dispensary space. Our proposed building is 1,395 square feet in size including



utility areas and requires 6 parking spaces ( $1,395 / 250 = 6$  parking spaces) to be compliant with city code. The City also requires 1 bicycle parking space for every 5,000 square feet of retail space, which our redesigned site will include. This will help to encourage alternative transportation methods by providing customers choosing to bike to the business a place to secure their bicycles outside.

#### *Storefront, Signage and Window Treatments*

Our property will only include one discreet sign advertising our business at this location. Before any signage is installed, we will comply with the City's sign ordinance by applying for a permit with drawings and/or specifications. We intend to only advertise the name of our business with no product information or any marketing slogans indicating that we are a dispensary.

We have already replaced several windows on the building, which did not require a permit, as they were inserted without any modifications to the building. We will continue to replace any remaining windows as the new windows are more attractive, dual pane, and higher quality, meaning greater energy efficiency within.

#### *Interior*

Moving into the building, we propose to improve the interior with a designated front lobby that is in compliance with state regulations. This front reception area will be where we check in and verify visitors and also where our queue for showroom entry will wait. We will improve this room with attractive laminate flooring, painting, waiting room furniture, and a security window for our staff to safely verify visitors. Once verified, our guests will be buzzed into our showroom, which will be similar in appearance to the photo below. This attractive showroom will provide a comfortable environment for our customers to preview our products, obtain education from our skilled budtenders, and complete their orders.





We have set aside a designated room for receiving vendors adjacent to our secured storage room, allowing our employees to discretely purchase and store products out of sight of any visitors. This room also provides added security, as vendors will first be verified and then unable to access our restricted access storage room without additional entry approval. We will install a panic button and surveillance cameras in this room as well as our lobby and show room to further prevent any unlikely robberies should they happen to circumvent our onsite security personnel and verification protocols. The remainder of our building will be improved with upgraded commercial ADA compliant bathrooms, offices for dispatchers and management, and a breakroom in the back.

*Pedestrian Orientation and Access to Transit*

One of several key features of the 316 Yolanda Avenue property is its proximity to downtown Santa Rosa and the local bus system. The closest bus stop is located at the northeast corner of Yolanda Avenue and Santa Rosa Avenue less than 200 feet from our proposed dispensary. There are also bus stops approximately 0.2 and 0.5 miles away from the property that are served by multiple bus lines. The proximity of these bus stops will provide a way for customers and employees of our facility living downtown to travel to the business using public transit. As discussed, we will make special discounts available to those who use Santa Rosa’s public transportation as a way to increase the City’s safety and lessen the traffic and parking burden on our property. In consideration of those whose conditions render them unsafe to drive, our educational and outreach programs will encourage use of the City’s public transit as a means of procuring their needed medication.



The pedestrian entrance to the business faces Yolanda Avenue, making it easy to monitor foot traffic to the site. Signage will identify the business name and information, indicating where pedestrians can enter the building.



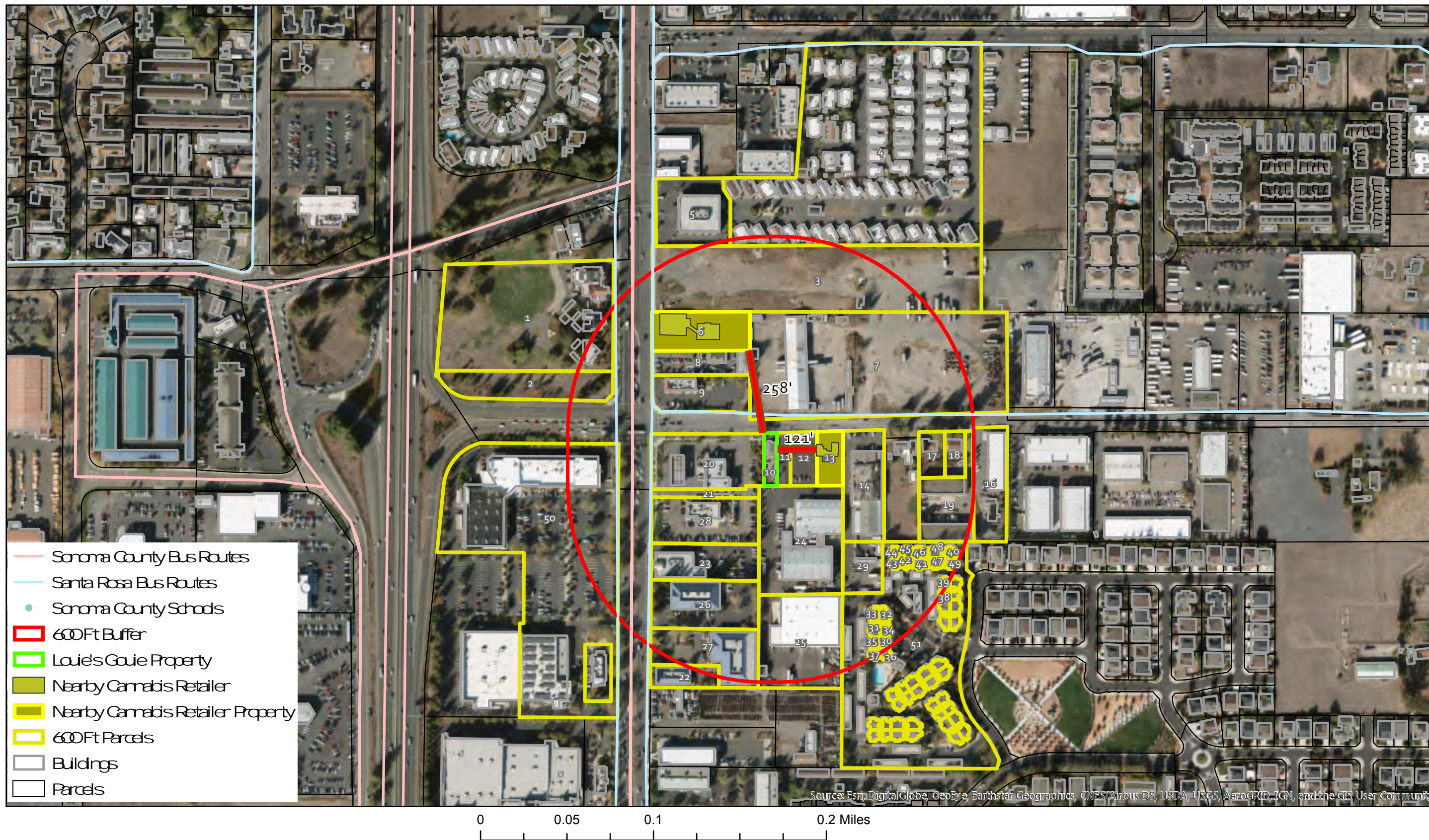

- Sonoma County Bus Routes
- Santa Rosa Bus Routes
- Sonoma County Schools
- 600Ft Buffer
- Louie's Cove Property
- Nearby Cannabis Retailer
- Nearby Cannabis Retailer Property
- Buildings
- Parcels



0 0.05 0.1 0.2 Miles

# Neighborhood Context Map



APN 044-072-005  
316 Ydamba Avenue, Santa Rosa

Note: Properties within 600 feet are numbered and correspond to the attached table

Date: 6-18-18



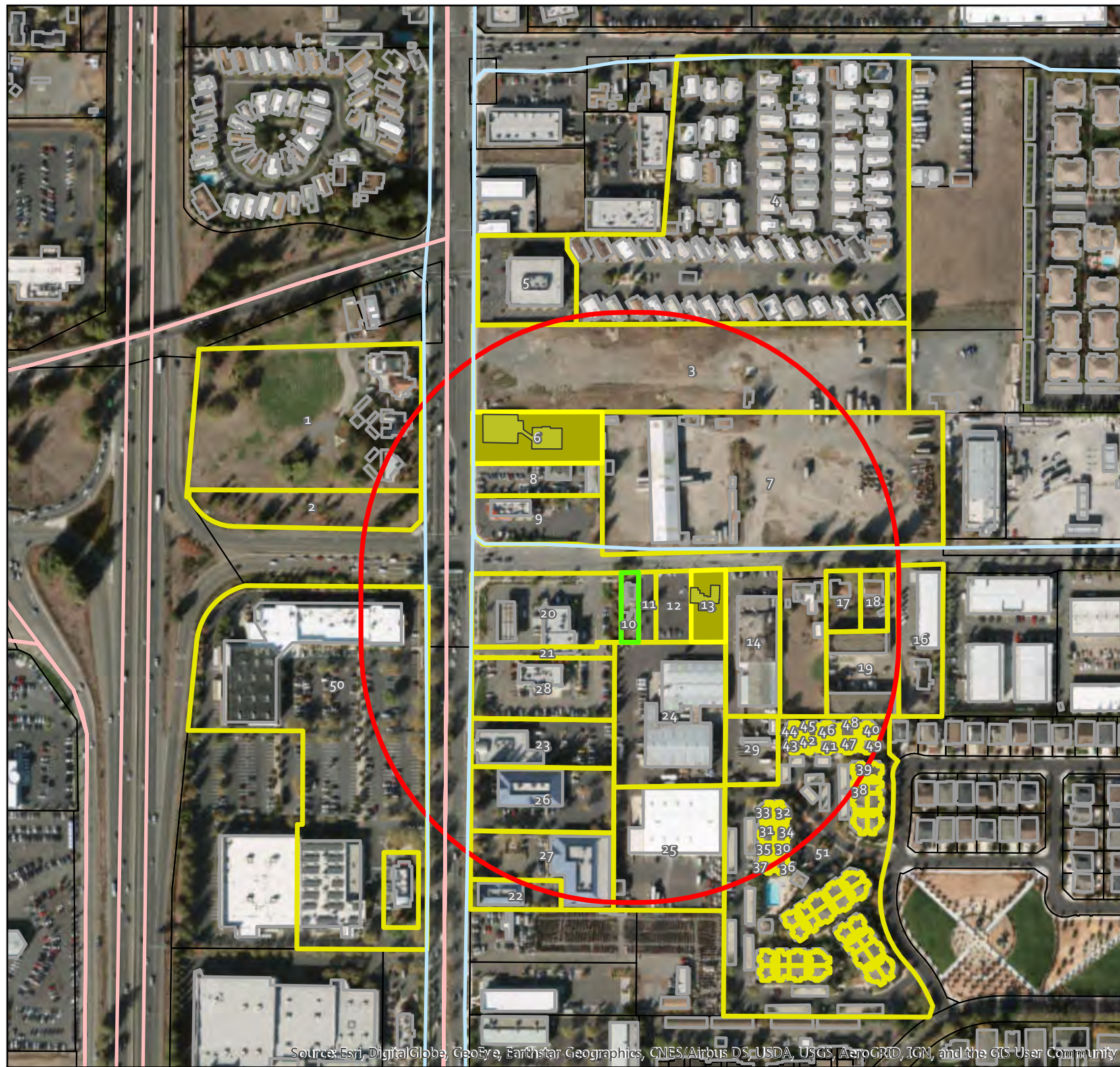

Source: Esri, DigitalGlobe, GeoEye, Earthstar Geographics, CNES/Airbus DS, USDA, USGS, AeroGRID, IGN, and the GIS User Community



ID APN	Owner	S Street Address	UseCodType
50 043-102019		8905 TOWNE CENTRE DR # 108, SANTA ROSA, CA 95452	Commercial
1 043-102025	SENTINEL CREMATION SOCIETIES INC	2607 SANTA ROSA AVE, SANTA ROSA, CA 95404	Commercial
2 043-102026	SE COMBINED SERVICES OF CALIFORNIA INC	SANTA ROSA AVE, SANTA ROSA, CA 95405	Residential
3 044-041-010	HULLSMAN TRANSPORTATION CO	2532 SANTA ROSA AVE, SANTA ROSA, CA 95406	Commercial
4 044-041-090	CARRIAGE COURT MHP LLC	250 KAVANA SPRINGS RD, SANTA ROSA, CA 95407	Commercial
5 044-041-101	VEALE HENRY KIRK	2510 SANTA ROSA AVE, SANTA ROSA, CA 95408	Commercial
6 044-071-001	NATOLI GROUP 1 LLC	2612 SANTA ROSA AVE, SANTA ROSA, CA 95409	Commercial
7 044-071-002	HULLSMAN PAUL JOSEPH ET AL	325 YOLANDA AVE, SANTA ROSA, CA 95410	Commercial
8 044-071-004	NATOLI GROUP 1 LLC	2620 SANTA ROSA AVE, SANTA ROSA, CA 95411	Commercial
9 044-071-007	ARCHLAND PROPERTY II LP ET AL	2642 SANTA ROSA AVE, SANTA ROSA, CA 95412	Commercial
10 044-072-005	BARRETTA RICK SHERWIN ET AL	316 YOLANDA AVE, SANTA ROSA, CA 95413	Residential
11 044-072-006	HENDERSON ALLANA & KIMBERLY L TR	324 YOLANDA AVE, SANTA ROSA, CA 95414	Commercial
12 044-072-007	HENDERSON ALLANA & KIMBERLY L TR	330 YOLANDA AVE, SANTA ROSA, CA 95415	Commercial
13 044-072-008	HENDERSON ALLANA & KIMBERLY L TR	350 YOLANDA AVE, SANTA ROSA, CA 95416	Commercial
14 044-072-009	HENDERSON ALLANA & KIMBERLY L TR	368 YOLANDA AVE, SANTA ROSA, CA 95417	Commercial
16 044-072-012	MAHANGINA TRET AL	414 YOLANDA AVE, SANTA ROSA, CA 95418	Commercial
17 044-072-019	DREVERIC W TR & DREW MARY A TR	376 YOLANDA AVE, SANTA ROSA, CA 95419	Residential
18 044-072-021	DREVERIC W TR & DREW MARY A TR	380 YOLANDA AVE, SANTA ROSA, CA 95420	Residential
19 044-072-022	DREVERIC W TR & DREW MARY A TR	394 YOLANDA AVE A, SANTA ROSA, CA 95421	Commercial
20 044-072-023	C & H DEVELOPMENT CO	2648 SANTA ROSA AVE, SANTA ROSA, CA 95422	Commercial
21 044-072-024	C & H DEVELOPMENT CO	SANTA ROSA AVE, SANTA ROSA, CA 95423	Commercial
22 044-081-005	FOULSEN HELGA F TR	2724 SANTA ROSA AVE, SANTA ROSA, CA 95424	Commercial
23 044-081-022	PROBST TONY C & INGRID R TR	2700 SANTA ROSA AVE, SANTA ROSA, CA 95425	Commercial
24 044-081-024	HENDERSON ALLANA & KIMBERLY L TR	NONE, SANTA ROSA, CA 95426	Commercial
25 044-081-029	HENDERSON ALLANA & KIMBERLY L TR	324 YOLANDA AVE, SANTA ROSA, CA 95427	Commercial
26 044-081-034	PARROTT JANICE CTRE ET AL	2716 SANTA ROSA AVE, SANTA ROSA, CA 95428	Commercial
27 044-081-035	CP&A SANTA ROSA LLC	2720 SANTA ROSA AVE, SANTA ROSA, CA 95429	Commercial
28 044-081-036	SANGUINETTI NORMAN H TR & SANGUINETTI GLADYS D TR	2688 SANTA ROSA AVE, SANTA ROSA, CA 95430	Commercial
29 044-390-061	HENDERSON ALLANA & KIMBERLY L TR	NONE, SANTA ROSA, CA 95431	Commercial
30 044-480-055	DOMFI 16 HARVEST PARK LLC	2335 SUMMERCREEK DR 55, SANTA ROSA, CA 95432	Residential
31 044-480-058	DOMFI 16 HARVEST PARK LLC	2335 SUMMERCREEK DR 58, SANTA ROSA, CA 95433	Residential
32 044-480-059	DOMFI 16 HARVEST PARK LLC	2335 SUMMERCREEK DR 59, SANTA ROSA, CA 95434	Residential
33 044-480-060	DOMFI 16 HARVEST PARK LLC	2335 SUMMERCREEK DR 60, SANTA ROSA, CA 95435	Residential
34 044-480-063	DOMFI 16 HARVEST PARK LLC	2335 SUMMERCREEK DR 63, SANTA ROSA, CA 95436	Residential
35 044-480-066	DOMFI 16 HARVEST PARK LLC	2335 SUMMERCREEK DR 66, SANTA ROSA, CA 95437	Residential
36 044-480-067	DOMFI 16 HARVEST PARK LLC	2335 SUMMERCREEK DR 67, SANTA ROSA, CA 95438	Residential
37 044-480-068	DOMFI 16 HARVEST PARK LLC	2335 SUMMERCREEK DR 68, SANTA ROSA, CA 95439	Residential
38 044-480-074	DOMFI 16 HARVEST PARK LLC	2343 SUMMERCREEK DR 74, SANTA ROSA, CA 95440	Residential
39 044-480-078	DOMFI 16 HARVEST PARK LLC	2343 SUMMERCREEK DR 78, SANTA ROSA, CA 95441	Residential
40 044-480-086	DOMFI 16 HARVEST PARK LLC	2347 SUMMERCREEK DR 86, SANTA ROSA, CA 95442	Residential
41 044-480-089	DOMFI 16 HARVEST PARK LLC	2347 SUMMERCREEK DR 89, SANTA ROSA, CA 95443	Residential
42 044-480-091	DOMFI 16 HARVEST PARK LLC	2347 SUMMERCREEK DR 91, SANTA ROSA, CA 95444	Residential
43 044-480-093	DOMFI 16 HARVEST PARK LLC	2347 SUMMERCREEK DR 93, SANTA ROSA, CA 95445	Residential
44 044-480-096	DOMFI 16 HARVEST PARK LLC	2347 SUMMERCREEK DR 96, SANTA ROSA, CA 95446	Residential
45 044-480-098	DOMFI 16 HARVEST PARK LLC	2347 SUMMERCREEK DR 98, SANTA ROSA, CA 95447	Residential
46 044-480-100	DOMFI 16 HARVEST PARK LLC	2347 SUMMERCREEK DR 100, SANTA ROSA, CA 95448	Residential
47 044-480-101	DOMFI 16 HARVEST PARK LLC	2347 SUMMERCREEK DR 101, SANTA ROSA, CA 95449	Residential
48 044-480-102	DOMFI 16 HARVEST PARK LLC	2347 SUMMERCREEK DR 102, SANTA ROSA, CA 95450	Residential
49 044-480-103	DOMFI 16 HARVEST PARK LLC	2347 SUMMERCREEK DR 103, SANTA ROSA, CA 95451	Residential
51 044-480-000	DOMFI 16 HARVEST PARK LLC	2347 SUMMERCREEK DR, SANTA ROSA, CA 95453	Residential

# Neighborhood Context Map-Table

APN 044-072-005  
316 Ydanda Avenue, Santa Rosa

Note: Properties within 600 feet are numbered and correspond to the attached table



Date: 6-18-18



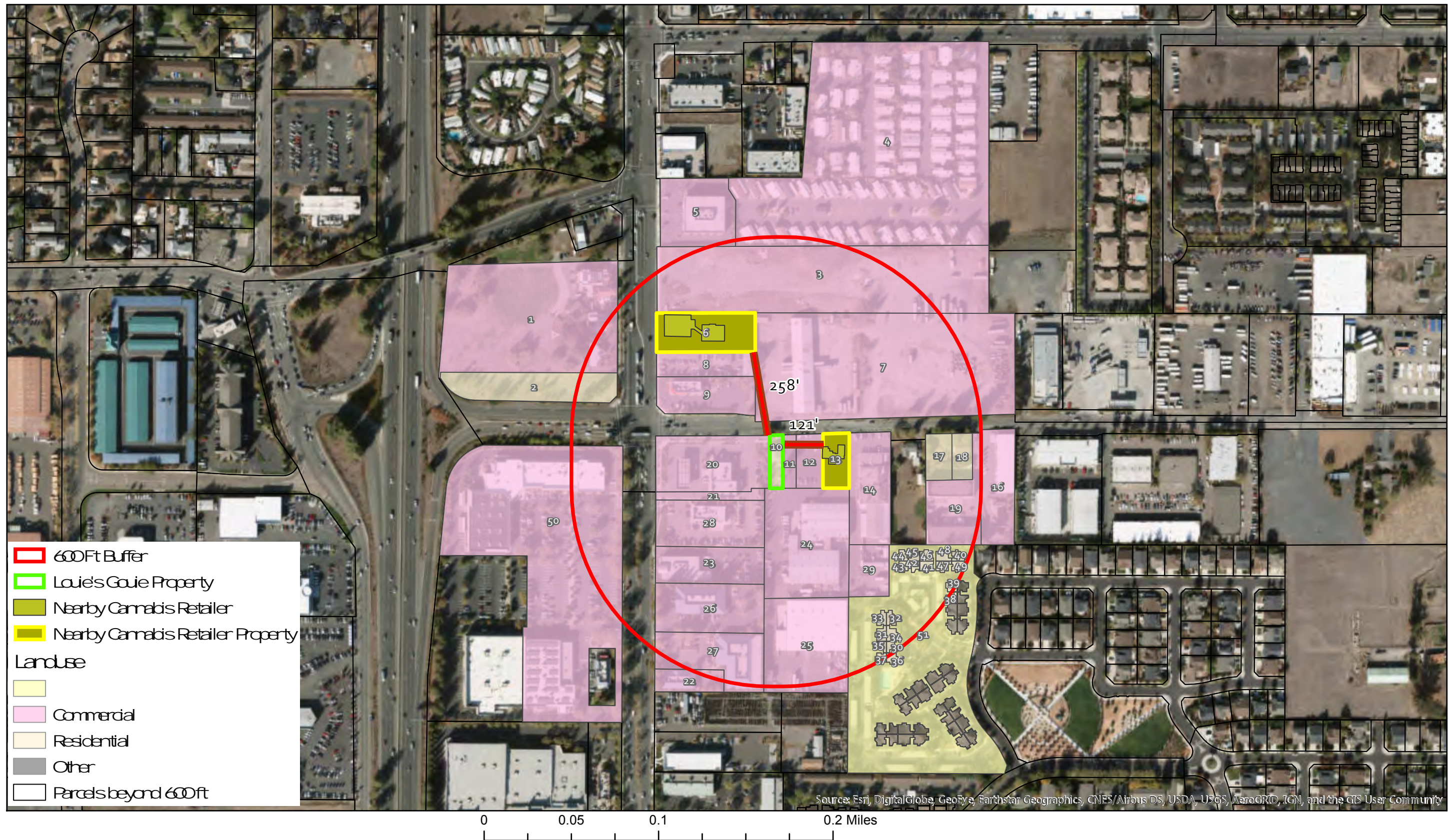

# Neighborhood Context Map-Landuse



APN 044-072-005  
 316 Ydamba Avenue, Santa Rosa

Note: Properties within 600 feet are numbered and correspond to the attached table

Date: 6-18-18





## D. Neighborhood Enhancement

### D1. Quality and Extent of Improvements to the Site, Building & Surrounding Neighborhoods

We propose to locate our storefront retail dispensary at 316 Yolanda Avenue. This location is completely surrounded by commercial and industrial land uses surround the property, most of which are poorly maintained to severely decrepit. As can be seen on our attached Neighborhood Photo Plate, Property Photo Plate, and Neighborhood Context/Land Use Maps, our location is arguably the worst property on the street and badly in need of repair. The only nearby property in good condition is the retail complex at the corner of Yolanda and Santa Rosa Avenues.

Our context maps demonstrate that our proposed dispensary is more than 600 feet away from any sensitive use, as defined by state law and City code, including schools, daycare centers, or youth centers. In addition, the only residential properties within 600 feet are located on the other side of our southern neighbor and not within view of our property.

We have included land use and zoning information on the attached context maps indicating that our property is zoned commercial. Although the property contains a house and has been used for residential uses, we propose to change the use to commercial retail. This change is consistent with the City of Santa Rosa General Plan, as it coincides with the current City zoning map. In addition, our proposed retail use is very compatible with surrounding uses that include retail and industrial. Both our context maps and architectural plans demonstrate that our storefront entrance is in a visible location that provides an unobstructed view from the public right-of-way.

We have identified on our context map two nearby properties that are also proposing cannabis storefront retail. The closest proposed retail property is immediately adjacent to our own, as shown in the photo below at 330 Yolanda Avenue. The use proposed for this location is a microbusiness, which would reconstruct the current auto dealership in the front and renovate the rear buildings for cultivation, manufacturing, and distribution. The second proposed dispensary would also be a part of a microbusiness and located at 2612 Santa Rosa Avenue. Both properties are much larger than our own, meaning a dispensary at either location would also be larger and have a more significant impact on the neighborhood. We feel that our dispensary location offers more significant benefits to the city, for the following reasons:

- Our property is more likely to connect to the pedestrian-friendly sidewalk and landscaping already developed on the adjacent retail complex;
- Our property will be more likely to take advantage of the City and County bus routes on Santa Rosa Avenue with pedestrian-friendly improvements;
- Our property is more dilapidated than any other building in the area, meaning our rehabilitation and secure, customer-friendly operation will make a more dramatic improvement; and
- Our smaller “mom and pop” storefront and added delivery service will reduce vehicular traffic in the area compared to a megastore at either of the other two locations.



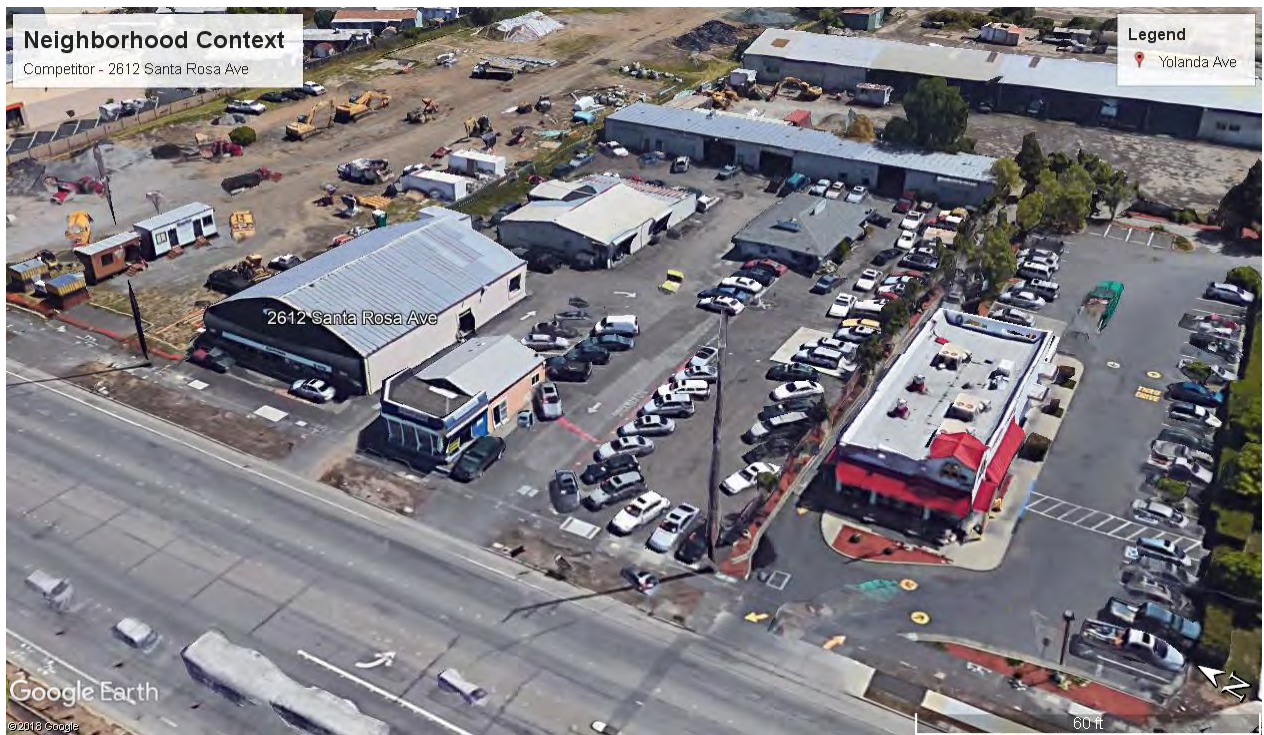



## D2. Integration through Attractive Façade, Setbacks, Quality Materials and Colors, Landscaping, Safe Circulation and Location of Driveways, and Ease of Parking

As indicated previously, our property is the most dilapidated on Yolanda Avenue, with the possible exception of the industrial property across the street (see neighborhood photo plate). The property was previously used as a residence and still contains the various walls, bedrooms, kitchens, and baths. The previous tenant operated an illegal cultivation operation that utilized the entire house, as well as several degraded sheds in the back yard that are now considered a nuisance by our neighbors. As a result of this illegal activity and along with compounded poor maintenance, the property is now in very poor shape. In addition, the front yard has and continues to be used as a parking lot, with no landscaping, and severely compacted soils.

The back yard is also poorly maintained with overgrown vegetation, mismatched fencing, and inclusion of barbed wire along the top of the fence. Finally, the adjacent retail property to the west is currently used by the local homeless population as a camp along the entire length of our fence, as it affords shade and some seclusion. These individuals are not only causing an eye-sore but also regularly leave trash and debris along the fence and the front of our property.

### **Proposed Property Improvements**

Our proposal is to completely rehabilitate the property, which would include the following improvements (Please refer to architectural plans for improvement specifications):

- Exterior Improvements
  - Installation of attractive landscaping in the front and rear yards, particularly along the street
  - Removal of all dilapidated fencing
  - Removal of all wood sheds in the back yard
  - Installation of a 6-space rear parking lot and an ADA parking space in the front yard
  - Installation of security lights in the front and rear of the property in compliance with the City's lighting ordinance
  - Installation of walkways in the front and rear yards
  - ADA accessible ramp improvements with a railing at the front entrance
  - Upgraded windows (inserts) for the entire existing building
  - Exterior painting and trim
- Interior Improvements
  - Relocation of interior walls
  - Installation of laminate flooring
  - Installation of granite countertops
  - Interior painting and trim
  - ADA improvements to both bathrooms
  - Installation of restricted access security doors
  - Installation of security and surveillance equipment
  - Installation of retail showroom cabinets
  - Installation of security window in lobby

The goal of our improvements will be twofold. First, we want to demonstrate to our neighbors how a legal retail dispensary should look and operate. Once we are in operation, they will begin to understand that our retail establishment is no different than the adjacent retail complex that includes Subway, Starbucks, and several other businesses. Additionally, they will be impressed by how our property improvements,





maintenance, security personnel, surveillance, and adherence to good standard operating procedures actually improves the area far beyond a typical retail store. In fact, recent studies from Colorado and other parts of California have determined that in contrast to previous beliefs, properly run cannabis dispensaries actually increase property values, safety, and significantly increase profitability of nearby businesses as our patrons are more likely to make other purchases while in the area. Additionally, they will see that inclusion of our delivery service helps greatly to moderate vehicular traffic activity and our incentive program for mass transit and shared ride users increases pedestrians on the streets.

### *Exterior*

Second, we want to create an excellent user experience for our customers starting with maintaining a clean exterior parking lot and entryway. Our front entry is approximately 40 feet from the existing road. Our walkways, ADA accessible ramp, and entryways will all be improved to current commercial building code, including the addition of a railing to the front entry ramp. As per our architectural plans, the railings, tread, slope, door handles, and thresholds will be compliant with California and City building codes, as well as ADA standards. Per our lighting plan, all parking areas and building entries will be illuminated with City code compliant lighting that improves security and visibility on the property while shielding light pollution that may otherwise cause a nuisance. We have already started the process of replacing the existing windows with new and attractive double-pane windows. We plan to repaint the entire exterior including trim, which will provide our building with a much-needed face lift. All entry doors will be replaced with high-quality security doors that prevent any potential robberies but are also attractive.

### *Parking Analysis*

The property redesign will include a rear parking lot containing 6 parking stalls and a front parking area with 1 ADA accessible space. The City of Santa Rosa parking regulations require one (1) space for every 250 square feet of retail dispensary space. Our proposed building is 1,395 square feet in size including utility areas and requires 6 parking spaces ( $1,395 / 250 = 6$  parking spaces) to be compliant with city code. The City also requires 1 bicycle parking space for every 5,000 square feet of retail space, which our redesigned site will include. This will help to encourage alternative transportation methods by providing customers choosing to bike to the business a place to secure their bicycles outside.

### *Storefront, Signage and Window Treatments*

Our property will only include one discreet sign advertising our business at this location. Before any signage is installed, we will comply with the City's sign ordinance by applying for a permit with drawings and/or specifications. We intend to only advertise the name of our business with no product information or any marketing slogans indicating that we are a dispensary.

We have already replaced several windows on the building, which did not require a permit, as they were inserted without any modifications to the building. We will continue to replace any remaining windows as the new windows are more attractive, dual pane, and higher quality, meaning greater energy efficiency within.

### *Interior*

Moving into the building, we propose to improve the interior with a designated front lobby that is in compliance with state regulations. This front reception area will be where we check in and verify visitors and also where our queue for showroom entry will wait. We will improve this room with attractive

laminated flooring, painting, waiting room furniture, and a security window for our staff to safely verify visitors. Once verified, our guests will be buzzed into our showroom, which will be similar in appearance to the photo below. This attractive showroom will provide a comfortable environment for our customers to preview our products, obtain education from our skilled budtenders, and complete their orders.



We have set aside a designated room for receiving vendors adjacent to our secured storage room, allowing our employees to discretely purchase and store products out of sight of any visitors. This room also provides added security, as vendors will first be verified and then unable to access our restricted access storage room without additional entry approval. We will install a panic button and surveillance cameras in this room as well as our lobby and show room to further prevent any unlikely robberies should they happen to circumvent our onsite security personnel and verification protocols. The remainder of our building will be improved with upgraded commercial ADA compliant bathrooms, offices for dispatchers and management, and a breakroom in the back.

#### *Secured Storage*

We have designated a secured storage room on our plans where we intend to store our valuable products. This room will be designed and constructed to prevent any type of forced entry. Additionally, we intend to reinforce the exterior wall with materials such as sheet metal and additional wood members to prevent the possibility of breaking through. The room will also be equipped with a motion sensor, surveillance camera, and panic button as part of our security system, explained further in our security plan.

#### *Security Doors and Windows*



We intend to install security doors at all exterior entries and those interior openings identified in the security plan. Our doors will either be the same, or similar to the door systems described on the attached security door specifications by GSS Doors. In summary, these doors are designed to help create a secure environment for locations with extremely high threat profiles or security challenges. This door was tested at NTS Chesapeake in Belcamp, MD to the U.S. State Department (DoS) forced entry standards and are bullet and forced entry resistant.

We also plan to install a security window similar to the attached product catalog for the CRL Bullet Resistant Windows. This window is designed to allow our staff to interact with visitors safely while checking credentials. Once verified, the visitor will be buzzed into our restricted access show room. If instead the person cannot be verified, they will not be allowed entry.

### D3. Environmental Benefits – Green Business Practices Related to Energy and/or Water Conservation

#### **Environmental Benefits**

Our dispensary is committed to green building and operating practices to reduce impacts on landfills, air quality, traffic, and energy consumption. First, our decision to locate our business at 316 Yolanda Avenue will benefit the city and environment by rehabilitating the previously dilapidated property and structure and improving the quality of the neighborhood. The current facility will require many improvements to both the interior and exterior prior to opening its doors for interaction with the public. We view these necessary improvements as an opportunity to contribute to “Green” business practices in the local community.

Second, our remodeling efforts have and will include reuse of as much of the existing materials as possible while also ensuring compliance to local and state regulations. Improvements to our building will also include state-of-the art climate control and automated technology solutions based on current Title 24 building standards to reduce heating/cooling energy costs, as well as installation of LED and energy efficient lighting in overhead lamps and fixtures to reduce our carbon footprint.

Third, our parking reduction incentive program will reduce the number of vehicles travelling to our dispensary, as well as associated air pollution. Our goal is to reduce air quality impacts compared with existing baselines established by the Air Resources Board for our type of retail land use entitlement by increasing the use of mass transit and ride shares, as well as to prevent air leakage from our building as much as possible.

Fourth, as a retail business, our operation will not include the use of water other than for bathroom and breakroom purposes. Similarly, we do not intend to produce a significant amount of trash and recyclables but will institute a program as noted in our waste management plan for reusing and recycling packaging received from vendors as much as possible.

### D4. Community Benefits – Employment Opportunities, Community Programs and Contributions

#### **Community Benefits**





Our team recognizes that the success of legal cannabis ultimately rests in its economic and social impact on communities across the state and country. That is why we are grateful for the opportunity to discuss the effects our business is most likely to have on the community from both the perspective of our past non-cannabis business experiences, our recent cannabis-related activities under Proposition 215 regulations, and our ongoing community involvement efforts with the democratic party, contributions to mental illness organizations, and other social organizations. We welcome dialogue from the City of Santa Rosa that will allow us to further discuss our commitment to the hometown where our owner has made his entire career.

### *Employment Opportunities*

Our team's employment projections are based on the conditions of the marketplace in its present state. As we succeed here in Santa Rosa, we are confident that other cities in the area will follow suit. Should other nearby localities begin to permit delivery of cannabis, our customer base could be impacted substantially. With the exception of this consideration, we expect to employ a total of up to three budtenders and one cashier per shift with two shifts occurring per day. We also anticipate maintaining three additional staff members to manage inventory, support employees on the floor, and dispatch delivery drivers. Additionally, our delivery service will employ up to five drivers per shift. Our company security plan requires a minimum of one security personnel on the premises throughout the workday and a patrol of the property during passive, non-working hours.

We anticipate the creation of approximately 29 new jobs over the next three years, with a minimum of 10 new employees upon completion of our licensing process in 2018. All of our recruiting efforts will be directed at local applicants who:

1. Reside within the county or surrounding areas;
2. Have interest in and knowledge of the cannabis industry;
3. Have successfully completed the required criminal background check; and
4. Who wish to learn more about growth within the industry.

We plan to give special preference to active military members and veterans who can benefit from employment opportunities in many ways. In addition to permanently retained employees, our facility will initially require the services of outside experts in marketing, IT, packaging and janitorial services, providing additional employment opportunities for the greater Santa Rosa community. In time, these services will become jobs created in-house, providing even more opportunities to locals.

Our team values the expertise and dedication to training that employees bring to their daily work. As has been our practice, we have included positions that can be filled through a program of upward mobility, providing valuable training and career opportunities that sustain employees and their families. Our equal employment opportunities will include in-house training that enhances employees' careers in many areas, even if they choose to pursue other types of employment in the future. In addition to cannabis-based training, onsite trainings and workshops will educate employees in areas like safety, hazard prevention, protective equipment, customer service, emergency response and harassment prevention as well as paid engagement seminars and conferences for management and marketing training. Once we are fully built



out, we expect to contribute well over one million in annual wages and benefits to the Santa Rosa economy from our location.

*Community Programs and Contributions*

Married for over 25 years, Luis and Delia Chavez have started, run and sold over 20 businesses, including three regulated and licensed operations. They have created jobs, exceeded customer expectations, and been very, very active members of their Santa Rosa community. Luis is loved by many for the big heart and spirit he contributes to the Santa Rosa needy children at Christmas or our homeless when they are hungry and scared.

Integrating legal cannabis into the community requires care and tact along with a dedicated effort. Our business owner, Luis Chavez, will serve as the primary Community Relations Liaison for Louie's Gouies.



## E. Waste Management & Recycling Plan

### E1. Cannabis Waste and Green Practices

We will contract with a licensed and professional cannabis waste management firm to properly and legally dispose of any cannabis our operation generates from product displays, returns or other activities that render cannabis not saleable. We expect our exposure in this regard to be limited as we have and will continue to develop relationships with our licensed distribution suppliers to ensure that they are not only compliant with their responsibilities but acting in the best interest of their business partners and the entire consumer community. Our products are intended to be effective and recommended with a high level of therapeutic accuracy to mitigate returns and waste.

As a retailer who is limited to the local supply of licensed distributors, our control over green exit packaging will be limited to market availability. As such, we plan to reward those manufacturers who utilize green over non-green packaging. We will also use green exit packaging wherever possible and encourage recycling of the materials we sell. All of the cardboard waste produced by our operation will be recycled through available means. Litter and debris will be monitored by regularly scheduled landscaping and daily by security and dispensary personnel.

### E2. Other Business Waste and Recycling

Our use of local services such as water and trash are expected to be no greater than any other business in the area. As a dispensary, our water consumption will be restricted to what one would expect from a typical busy retail operation, with the vast majority of the usage from the bath and break rooms.

Our business is committed to local recycling programs and will encourage staff through our standard operating procedures and employee training to separate recyclables and yard debris from our waste stream.



# Louie's Gouie's

## Manual of Standard Operating Policies

*Prepared in Conformance With the*  
California Code of Regulations, Title 16  
Division 42, Bureau of Cannabis Control  
Chapter 3, Retailers



# Table of Contents

---

- I. Retailers - General Provisions**
  - a. 5400 Access to retailer premises
  - a. 5401 Limited access areas
  - b. 5402 Retail area
  - c. 5403 Hours of operation
  - d. 5404 Retail customers
  - e. 5405 Cannabis goods display
  - f. 5406 Cannabis goods for sale
  - g. 5407 Sale of non-cannabis products on premises
  - h. 5408 Live plants
  - i. 5409 Daily limits
  - j. 5410 Customer return of cannabis goods
  - k. 5411 Free cannabis goods
  - l. 5412 Packaging and labeling
  - m. 5413 Exit packaging
  - n. 5414 Type 9-Non Storefront Retailer
  - o. 5415 Delivery
  - p. 5416 Delivery to a physical address
  - q. 5417 Methods of delivery
  - r. 5418 Cannabis goods carried during delivery
  - s. 5419 Cannabis consumption during delivery
  - t. 5420 Delivery request receipt
  - u. 5421 Delivery route
  - v. 5422 Receiving shipments of inventory
  - w. 5423 Inventory documentation
  - x. 5424 Inventory reconciliation
  - y. 5425 Record of sales
  - z. 5426 Records



## 5400. Access to Retailer Premises

The following section outlines the regulations on access to the premises

- 1** SOPs will be developed to ensure that access to the licensed premises of an A-retailer licensee will be limited to individuals who are at least 21 years of age and have a genuine business reason for entering the premises
  
- 2** In addition to Step #1 above, standards will be developed to ensure that access to the licensed premises of a M-retailer licensee will be limited to individuals who are at least 18 years of age and have a valid physician's recommendation
  
- 3** Standards developed under this SOP will recognize that if a licensed premises is shared by an A-license and an M-license according to section 5025 of the BCC Regulations for Retailers, the licensee may allow persons identified in Steps #1 and #2 above to access the premises

## 5401. Limited-Access Areas

The following section specifies areas of limited access

- 1 SOPs will be developed to ensure that limited-access areas are established and only authorized individuals are permitted to enter the retailer limited-access areas**

  - NOTE: Authorized individuals include individuals employed by the retailer as well as any outside vendors, contractors, or other individuals conducting business that requires access to the limited-access area
  
- 2 Standards will be developed to ensure that an individual in the retailer limited-access area who is not employed by the retailer will be escorted by the licensee's employees at all times within the retailer limited-access area**
  
- 3 All standards developed with respect to limited-access areas will include provisions to ensure that any individual who enters the retailer limited-access area will be at least 21 years of age**
  
- 4 Standards and tools will be developed to comply with the requirement that all retailers will maintain a log of all authorized individuals who are not employees of the retailer that enter the retailer limited-access area. These logs will be made available to the Bureau upon request**
  
- 5 Standards developed with respect to limited-access areas will ensure that the retailer does not receive consideration or compensation for permitting an individual to enter the retailer limited-access area**

## 5402. Retail Area

The following section specifies requirements and guidelines for access in the retail area

- 1 SOPs will be developed to ensure that individuals are granted access to the retail area only to purchase cannabis goods after the retailer or an employee of the retailer has verified that the individual is at least 21 years of age and has a valid proof of identification, or that the individual is at least 18 years of age, has valid proof of identification and a valid physician's recommendation for his or her self or for a person for whom he or she is a primary caregiver**
- 2 Standards will include provisions for acceptable forms of ID, which include the following:**

  1. A document issued by a federal, state, county, or municipal government, or a political subdivision or agency thereof, including, but not limited to, a valid motor vehicle operator's license, that contains the name, date of birth, physical description, and picture of the person; or
  2. A valid identification card issued to a member of the Armed Forces that includes a date of birth and a picture of the person; or
  3. A valid passport issued by the United States or by a foreign government
- 3 Standards developed under this SOP will recognize that a valid proof of identification must clearly indicate the age or birthdate of the individual**
- 4 Standards will be developed to ensure that either the retailer or its employees will be physically present in the retail area at all times when individuals who are not employees of the retailer are in the retail area**

## 5403. Hours of Operation

The following section specifies requirements and guidelines for hours of operation

**1 SOPs will be developed to ensure that sales are only performed between the hours of 6:00 a.m. Pacific Time and 10:00 p.m. Pacific Time**

**2 Standards will be developed to ensure that at any time the premises is not open for retail sales:**

1. The premises is securely locked with commercial-grade, non-residential door locks
2. The premises is equipped with an active alarm system which will be activated when the retailer or its employees are not on the licensed premises; and
3. Only employees and contractors of the retailer are allowed to enter the premises

## **5404. Retail Customers**

The following section specifies the parameters and definitions of retail customers

- 1** SOPs will be developed to ensure that the retailer will only sell adult-use cannabis goods to individuals who are at least 21 years of age, and medicinal cannabis goods to individuals at least 18 years of age who possess a valid physician's recommendation for his or her self or a person for whom he or she is a primary caregiver
  
- 2** Standards will be developed to ensure that identity, age and physician's recommendation if applicable are verified for each customer as required by SOP 5402 of this Manual



## 5405. Cannabis Goods Display

The following section specifies the parameters and definitions of retail customers

- 1 SOPs will be developed to ensure that cannabis goods for inspection and sale shall only be displayed in the retail area**
  
- 2 Standards will be developed to ensure that cannabis goods are not displayed in a place where they are visible from outside of the licensed premises**
  
- 3 Standards will be developed to ensure that during physical inspection by customers, cannabis goods may be removed from their packaging and placed in containers to allow for closer inspection. The containers will not be readily accessible to customers without assistance of retailer personnel. A container must be provided to the customer by the retailer or its employees, who will remain with the customer at all times that the container is being inspected by the customer**
  
- 4 Standards for the handling of cannabis goods removed from their packaging for display will be developed to ensure that such cannabis is not sold or consumed and will be destroyed according to Section 5054 of the BCC Regulations when the cannabis goods are no longer used for display**

## 5406. Cannabis Goods for Sale

The following section specifies the parameters for salable cannabis goods

- 1** **SOPs will be developed to ensure that cannabis goods are not made available for**   
**sale or delivery to a customer unless:**
1. The cannabis goods were received from a licensed distributor
  2. It has been verified that the cannabis goods have not exceeded their expiration or sell-by date if one is provided
  3. In the case of manufactured cannabis products, the product complies with all requirements of Business and Professions Code section 26130 and all other relevant laws

## **5407. Sale of Non-Cannabis Products on Premises**

The following section specifies parameters for sale of non-cannabis products on the premises

- 1 If the business desires to sell non-cannabis products on the licensed premises, standards will be developed to establish and maintain compliance with any city, county, and state laws or regulations related to those products. This provision excludes alcohol and alcohol products and tobacco and tobacco products from sale at any licensed premises**

## 5408. Live Plants

The following section refers to the sale of live plants

- 1 Standards for live plant sales will be developed as needed to ensure that only live,  immature cannabis plants and seeds are sold and only if all of the following requirements are met:**

1. The plant is not flowering;
2. The plant or seed was purchased from a nursery that holds a valid Type-4 license under the Act
3. A label is affixed to the plant or package containing any seeds which states "This product has not been tested pursuant to Medicinal and Adult-Use Cannabis Regulation and SafetyAct."

- 2 Standards regarding live plants will also be developed as needed to ensure the  following:**

1. The sale of any other live plants is prohibited
2. The application or use of any pesticide on or around live plants is strictly prohibited

## 5409. Daily Limits

The following section specifies the daily limits on sales to the two classes of cannabis customers

**1 SOPs will be developed to ensure that the following daily limits are enforced for  all adult-use cannabis customers:**

- No more than 28.5 grams of non-concentrated cannabis in a single day to a single customer
- No more than 8 grams of concentrated cannabis as defined in Business and Professions Code section 26001, including concentrated cannabis contained in cannabis products, in a single day to a single customer
- No more than 6 immature cannabis plants, in a single day to a single customer

**2 Standards will be developed to ensure that the following daily limits are enforced  for all medicinal cannabis customers:**

- No more than eight ounces of medicinal cannabis in a single day to a single medicinal cannabis customer



## 5410. Customer Return of Cannabis Goods

The following section defines the parameters for customer return of cannabis goods

- 1 SOPs will be developed to ensure that customer returns of cannabis goods are handled in compliance with all department regulations**

- NOTE: For the purposes of this section, “customer return” means a customer’s return of cannabis goods that were purchased from a retailer, back to the retailer the cannabis goods were purchased from

- 2 Standards will be developed to reflect the retailers disposition on returns of cannabis goods. A retailer may accept customer returns of cannabis goods that were previously sold to a customer**

- 3 Standards regarding return of cannabis goods will be developed as necessary to reflect that returned cannabis goods will not be resold and will be subject to the disposal and destruction requirements found in Sections 5054 and 5055 of the BCC Regulations**

- 4 Standards will also be developed to ensure that cannabis goods which are abandoned on the retail premises are treated as a customer return and subject to the disposal and destruction policy per Step #3 above**

## 5411. Free Cannabis Goods

The following section outlines the requirements and limitations for free cannabis goods offered by the retailer

**1 SOPs will be developed to ensure that free cannabis goods will not be provided by the business to any person, nor will individuals who are not employed by the business to provide free cannabis goods to any person on the licensed premises**

**2 Standards will be developed to ensure that regardless of section 1 above, in order to provide access to medicinal cannabis patients who have difficulty accessing medicinal cannabis goods, a licensee who holds a Type 10-Retailer M-license, a Type 9-Retailer Non-storefront-M license, or a microbusiness M-license which allows for retail sales, may provide free medicinal cannabis goods if all of the following criteria are met:**

1. Free cannabis goods are provided only to a medicinal cannabis patient or primary caregiver for the patient in possession of a valid identification card issued under Section 11362.71 of the Health and Safety Code
2. The cannabis goods comply with all applicable laboratory testing requirements under this division
3. Prior to being provided to the patient or primary caregiver, the cannabis goods have been properly recorded in the track and trace system as belonging to the retailer
4. The cannabis goods shall not leave the licensed premises unless placed in an opaque package as required for purchased cannabis goods under Business and Professions Code section 26070.1
5. The cannabis goods will be applied toward the daily limit purchased by a medicinal cannabis customer according to SOP 5409 of this Manual
6. The transaction will be properly recorded in the retailer's inventory records and the track and trace system

**3**

**Standards developed in accordance with this SOP will also consider that in addition to the provision of free cannabis goods in Step #2 above, a licensee may donate cannabis goods and the use of equipment in compliance with any compassionate use, equality, or other similar program administered by a local jurisdiction**



## **5412. Packaging and Labeling**

The following section specifies detailed requirements of packaging and labeling

- 1 Adherence to this SOP indicates that this retailer does not accept, possess, or sell  cannabis goods that are not packaged as they will be sold at final sale, in compliance with the division of Retail Requirements of the BCC**
  
- 2 Adherence to this SOP indicates that this retailer does not package or label  cannabis goods**

## **5413. Exit Packaging**

The following section specifies detailed requirements of exit packaging

- 1 Adherence to this SOP indicates that this retailer provides and opaque exit package for each customer purchase so that all products may discreetly exit the premises without being visible to the public**



## 5414. Type 9-Non-Storefront Retailer

The following section outlines the parameters of the Type-9-Non-Storefront Retailer license

**1 The following information will be referred to for questions regarding the activities authorized under a Type 9-Non-Storefront Retailer license:**



1. A Type 9-Non-Storefront Retailer licensee is authorized to conduct retail cannabis sales exclusively by delivery as defined in Business and Professions Code section 26001(p)
2. A complete application for a Type 9-Non-Storefront Retailer license includes all the information required in an application for a Type 10-Retailer license
3. A Type 9-Non-Storefront Retailer licensee will comply with all the requirements applicable to Type 10-Retailer licensees, except for those provisions related to public access to the premises
4. The licensed premises of a Type 9-Non-Storefront Retailer licensee will be closed to the public

## 5415. Delivery

The following section outlines the requirements specific to delivery of cannabis goods

- 1 SOPs will be created to ensure that all deliveries of cannabis goods are performed by a delivery employee of the business**
  
- 2 Standards will be created to ensure that each delivery employee hired by the business will be at least 21 years of age**
  
- 3 Standards will be created to ensure that all deliveries of cannabis goods will be made in person. A delivery of cannabis goods will not be made through the use of an unmanned vehicle**
  
- 4 Standards will be developed with adequate tracking procedures to ensure that the process of delivery begins when the delivery employee leaves the retailer's licensed premises with the cannabis goods for delivery, and ends when the delivery employee returns to the retailer's licensed premises after delivering the cannabis goods to the customer(s)**
  
- 5 Standards will be developed to ensure that delivery employees hired by the business will, during deliveries, carry a copy of the retailer's current license, the employee's government-issued identification, and an identification badge provided by the employer according to section 5043 of the BCC regulations**
  
- 6 Standards will be developed to ensure the creation and maintenance of an accurate list of delivery employees hired by the business**

## **5416. Delivery to a Physical Address**

The following section specifies requirements for delivery locations

- 1 SOPs will be developed to ensure that cannabis goods delivered by the business are delivered only to verified physical addresses in California**
  
- 2 Standards will be developed to ensure that delivery employees will not leave the State of California while possessing cannabis goods**
  
- 3 Standards will be developed to ensure that delivery drivers do not deliver goods to any address located on publicly owned land or any address on land or in a building leased by a public agency. This prohibition applies to land held in trust by the United States for a tribe or an individual tribal member unless the delivery is authorized by and consistent with applicable tribal law**

## 5417. Methods of Delivery

The following section specifies permitted methods of delivery

- 1** SOPs will be developed to ensure that delivery employees of the business carrying cannabis goods for delivery, will only travel in an enclosed motor vehicle operated by a delivery employee of the licensee/business
  
- 2** Standards will be created to ensure that while carrying cannabis goods for delivery, a retailer's delivery employee will ensure the cannabis goods are not visible to the public
  
- 3** Standards will be created to ensure that a delivery driver hired by the business will not leave cannabis goods in an unattended motor vehicle unless the motor vehicle is locked and equipped with an active vehicle alarm system
  
- 4** Standards will be developed to ensure that vehicles used for delivery of cannabis goods will be outfitted with a dedicated Global Positioning System (GPS) device for identifying the geographic location of the delivery vehicle. A dedicated GPS device must be owned by the licensee and used for delivery only. The device shall be either permanently or temporarily affixed to the delivery vehicle and shall remain active and inside of the delivery vehicle at all times during delivery. At all times, the retailer shall be able to identify the geographic location of all delivery vehicles that are making deliveries for the retailer and shall provide that information to the Bureau upon request

**5 Standards will be developed to ensure compliance with requests by the bureau**   
**which require the business to provide the Bureau with information regarding any motor vehicles used for the delivery of cannabis goods, including the vehicle's make, model, color, Vehicle Identification Number, license plate number and Department of Motor Vehicle's registration**

**6 Standards will be developed to ensure adequate preparation of delivery drivers**   
**for compliance with the following:**

- Any motor vehicle used by a retailer to deliver cannabis goods is subject to inspection by the Bureau. Vehicles used to deliver cannabis goods may be stopped and inspected by the Bureau at any licensed premises or during delivery

## **5418. Cannabis Goods Carried During Delivery**

The following section defines the limits of cannabis goods carried during delivery

- 1 SOPs pertaining to deliveries will be created to ensure that delivery drivers hired  by the business will not carry cannabis goods worth in excess of \$3,000 at any time. This value will be determined using the current retail price of all cannabis goods carried by the delivery employee**



## **5419. Cannabis Consumption During Delivery**

The following section defines the limits of cannabis consumption during delivery

- 1 SOPs pertaining to deliveries will be created to ensure that delivery drivers hired  by the business will not consume cannabis goods while delivery cannabis goods to consumers**

## 5420. Delivery Request Receipt

The following section specifies what should be on the delivery request receipt

**1 SOPs will be created to ensure that a delivery request receipt is prepared for each delivery of cannabis goods. Each receipt will contain the following:**

1. The name and address of the retailer
2. The first name and employee number of the retailer's delivery employee who delivered the order
3. The first name and employee number of the retailer's employee who prepared the order for delivery
4. The first name of the customer and a retailer assigned customer number for the person who requested the delivery
5. The date and time the delivery request was made
6. The delivery address
7. A detailed description of all cannabis goods requested for delivery. The description will include the weight, volume, or any other accurate measure of the amount of any cannabis goods requested
8. The total amount paid for the delivery, including any taxes, fees, the cost of the cannabis goods, and any other charges related to the delivery
9. Upon delivery, the date and time the delivery was made, and the signature of the customer who received the delivery

**2 Standards will be developed to ensure that at the time of the delivery, the delivery employee will provide the customer, who placed the order a copy of the delivery request receipt. The delivery employee will retain a signed copy of the delivery request receipt for the retailer's records**

## 5421. Delivery Route

The following section defines the parameters of an acceptable delivery route

**1 SOPs will be developed to ensure that delivery drivers follow only approved routes to and from the licensed facility. For the purposes of this SOP, the following apply:**



1. While making deliveries of cannabis goods, a retailer's delivery employee shall only travel from the retailer's licensed premises to the delivery address;
2. From one delivery address to another delivery address; or
3. From a delivery address back to the retailer's licensed premises.
4. A delivery employee of a retailer will not deviate from the delivery path described in this section, except for necessary rest, fuel, or vehicle repair stops, or because road conditions make continued use of the route unsafe, impossible, or impracticable

## 5422. Receiving Shipments of Inventory

The following section specifies regulations applicable to inventory shipments received by the business

**1 SOPs will be developed to ensure that shipments of cannabis goods are received only from a distributor**

**2 Standards will be developed to ensure that shipments of cannabis goods are accepted by the business only between the hours of 6:00 a.m. Pacific Time to 10:00 p.m. Pacific Time**

**3 Standards will be developed to ensure that during business hours, shipments of cannabis goods will not enter the premises through an entrance or exit that is available for use by the public**

## 5423. Inventory Documentation

The following section specifies the requirements for inventory documentation

**1 SOPs will be developed to ensure that accurate record of the business inventory  is created and maintained. This record is subject to inspection by the Bureau and must be provided upon request. The business will keep a record of the following information for all cannabis goods held in the business' inventory:**

1. A description of each item in the retailer's inventory. This description will be such that the cannabis goods can easily be identified
2. An accurate measurement of the quantity of the item
3. The date and time the cannabis goods were received by the retailer
4. The sell-by or expiration date on any cannabis goods, if any
5. The name and license number of the licensee that delivered the cannabis goods to the retailer
6. The name and license number of the distributor that provided the cannabis goods to the retailer
7. The price the retailer paid for the cannabis goods, including taxes, delivery costs, or any other costs

## 5424. Inventory Reconciliation

The following section specifies the requirements for inventory reconciliation

- 1 SOPs will be developed to ensure that reconciliation of retail inventory is performed at least once every 14 days**
  
- 2 Standards will be developed to ensure that inventory records will be verified and matched with a physical inspection of inventory to maintain consistent recording**
  
- 3 Standards will be developed to ensure that results of inventory reconciliation will be retained in the business records and will be made available to the Bureau upon request**
  
- 4 Standards will be developed to ensure that if any evidence of theft, diversion, or loss is identified, the Bureau and law enforcement will be notified according to Section 5036 of the BCC Regulations**
  
- 5 Standards will be developed to ensure that if a significant discrepancy as defined in Section 5034 of the BCC Regulations is discovered between the retailer's physical inventory and inventory records, the retailer shall notify the Bureau and law enforcement in accordance with Section 5036 of the BCC Regulations**



## 5425. Record of Sales

The following section specifies the requirements for recording sales

**1** **SOPs will be developed to ensure that the business maintains an accurate record of sales for every sale made to a customer. A record of medicinal cannabis goods sale will contain the following information:**

- The first name and employee number of the retailer employee who processed the sale
- The first name of the customer and a retailer assigned customer number for the person who made the purchase
- The date and time of the transaction
- A list of all the cannabis goods purchased, including the quantity purchased
- The total amount paid for the sale including the individual prices paid for each cannabis good purchased and any amounts paid for taxes

## **5426. Records**

The following section specifies the appropriate reference for specifics related to record maintenance

- 1 SOPs will be developed to ensure that all retailer-specific records in this Manual  will be maintained in accordance with Section 5037 of the BCC Regulations**



## Armed Robbery Prevention and Procedures

Armed robbery is one of the most serious and potentially dangerous crimes committed in the United States today. A robber commits a hold-up because he or she believes that their profit will be worth the risk. By decreasing the possible profit and increasing the risk of apprehension, potential victims can reduce their chance of becoming a target. Personal safety is always the most important consideration when planning how to react to an armed robbery. This document provides basic information that can and will diminish the chance of becoming a victim

### What to Do Before You Are Robbed

Businesses must face the possibility of robbery on their premises realistically, and they should give security training a high priority. Employees will be trained in the latest methods of robbery prevention, which will improve their chances for safety and their ability to provide information that could help in the apprehension of the criminal. In addition, this preparation can lessen the emotional after effects of being involved in an armed robbery.

- Opening and closing procedures should be established. These could include:

Have several employees present when opening and closing the business.

Inspect the business for forcible entry before entering the business. – One employee searches the premises before admitting others. If all is clear, the employee entering the facility first can signal the companion with some prearranged sign. – At closing make sure no one is hiding in the business. – At closing one employee can enter the parking lot first and can signal the companion with some prearranged sign if it is safe.

- Every business should operate with a cash protection system. Each employee handling cash should be trained in the various possible types of attack, and the employee should follow good cash handling practices. The cash system should work two ways by protecting both lives and money. Periodic checks should be made to be sure all cash protection rules are being followed. By following these cash handling procedures, the business will make it a less attractive “mark” and limit the robber’s profit while reducing the business’ potential losses.

Keep a minimum of easily accessible cash on hand, and in the safe. Use a money safe that requires more than one employee to open. Always lock money safes after the day’s operating funds are obtained. Serious loss can be reduced by having special separately locked inner compartments or lockers where the change funds are maintained. Dual control of safes and two-key inner compartment money safes require at least two people to open the door, thus helping to prevent robberies. Try not to open the cash safe too often.

Make sure employees do not display large amounts of money. This procedure should be accomplished in a designated secured office or other secure area less visible and vulnerable.



Do not allow employees to count large amounts of cash in areas visible either to the public or to other employees. Large amounts of money exposed to view represent a temptation not only to robbers but to employees and customers alike

Disguise the currency bags in plain wrappings or in another container (i.e., brief case, etc.) – Vary the personnel doing the deposit, if possible. – Vary the vehicle used. – Request police or armed guard protection when handling or transporting large amounts of money.

- Physical security measures include:

Maintaining a well-lighted interior visible from the street. Make sure signs, displays, plants, etc. do not obstruct the view from the street of the customer service area. Maintaining visibility into the business establishment at all times is important.

Storage rooms that have a lock that can be opened from the inside. Robbers sometimes lock employees in storage rooms. Hide a key in the room if the lock cannot be opened from the inside.

- Marking the edge of the doorway at varying heights to identify the height of a robber.
- Mechanisms that permit employees to have a complete view of their surroundings such as convex mirrors, an elevated vantage point, and placement of the employee area so that it is clearly visible outside the establishment serve as deterrents.
- Install barriers to keep unauthorized persons out of these restricted areas. – For secure areas, use doors and gates with latches that automatically lock on closing.
- Install a timed delay switch to turn off exterior lights after the employees have gone for the night. – Prominently displayed surveillance camera equipment. Be sure to have the equipment serviced regularly and to only use video tapes the amount of times recommended by the manufacturer.
- Use a dual key, drop or delay-action time-lock safe. – A silent alarm system. This alarm system:
  - Could incorporate a daytime holdup feature that reports to a remote supervised area. Make sure employees know how and when, and when not, to activate the alarm.
  - Could be unobtrusively activated by an employee who is forced to open the safe or vault.
  - Including standby power and transmission method, should be tested periodically. When accidentally set off or when it malfunctions, it should be reported immediately to the police to insure an adequate response.
- Should be taught to new employees and periodically reviewed with those employees who need to know.
- Seldom used rear and side doors, windows, and other accessible openings should be kept locked always. Doors should have viewers. Doors used for deliveries should be locked when not in use.
- Maintain good exterior lighting. Adequate outside lighting of the parking area and approach to the business during nighttime hours of operation enhances employee protection. Surveillance lighting to detect and observe pedestrian and vehicular entrances of the business can also help. Adequate lighting within and outside the establishment makes the facility less appealing to a potential robber by making detection more likely.



- All shrubbery and trees, that a criminal could use to hide, should be cut back and maintained.

In certain high-risk areas or businesses, consideration should be given to the use of additional deterrents. These may include:

- The presence of off-duty police or uniformed guards. The use of an armored car service for delivery and pick-up of cash.
- Maintain a list of emergency contact telephone numbers near the telephone. Have witness description forms available for employees and witnesses to complete after a robbery has occurred.
- Vary lunch hours and coffee breaks so several employees are always on duty.
- Employees should be trained to watch for and report suspicious actions of people inside and immediately outside the premises. Don't hesitate to call the police when worried about a potential risk. Should the person leave before the officer's arrival, write down the description of the suspect and their vehicle for possible police use. A suspicious person that is seen today may turn out to be the robber who returns tomorrow. Examples of suspicious activity could include:
  - Persons monitoring business operations.
  - Persons asking about closing times, volume of business, the amount of money on hand, etc.
  - Persons who appear to just loiter in the area checking the business layout and operations.
  - Persons who may be waiting for a lull in activity and fewer customers.
- Give every customer entering the business a friendly greeting. Look each customer directly in the eyes. A robber does not want to be identified and such human contact may spoil it for some would-be robbers.
- Require employees to ask for the identification of workers, repair people, guards, police officers, etc. before permitting entry into secured areas.
- The counter or work area should be cleaned regularly to remove old fingerprints. This increases the possibilities that a robber may leave a readable print behind. Oil or wax-based cleaners should not be used.
- Try to have at least two employees on duty always. Employing two people is a form of "target hardening" because it may make a robbery more difficult to complete and, therefore, more unsuitable to a potential robber.
- Don't be tempted to use phony signs or equipment. The use of phony surveillance cameras, for example, can destroy the credibility of all other security precautions. Robbers soon learn to ignore them.
- Many police departments have procedures for alarm verification and robbery response. Finding out what they are is advisable so that the employees will know what to expect in case of an armed robbery.

### Procedures During a Robbery

Proper employee training of the procedures to follow during a robbery is vital to surviving the confrontation. Conduct documented training and discussion periods so that every employee knows their part and has an opportunity to ask questions. A few minutes of brief review on a regular basis will help to insure the proper reaction in case of a robbery. The overriding consideration in dealing with a robbery is to reduce the possibility of injury.

- Do not resist the robber. The product or money is not worth risking a life. Take no action that would jeopardize the safety of employees or customers. Cooperate with the robber and do not try to become a hero. In most situations, robbers almost never hurt anyone who cooperates.
- Do not use or encourage the use of weapons against the robber. Introducing another weapon into the situation increases the chances of someone becoming injured during the robbery. No amount of product or money is worth the risk of endangering a person's life.
- Try to inform the robber of any surprises. If someone is expected back soon or if you must reach or move in any way, tell the robber what to expect so they will not be startled. A suspicious move by an employee may trigger a violent reaction endangering the lives of many people.
- Follow the robber's commands, but do not volunteer to help. The longer the robbery takes, the more nervous the robber may become and more apt to become violent.
- If the robber demands a specific amount of product or money, only give them what they demand.
- Try to keep customers and employees calm during the robbery.
- If the robber displays a firearm or claims to have one, consider it loaded and that they would use it.
- Activate the holdup alarm, if possible, only if it can be safely done without being obvious to the robber.
- Try to alert other employees of the situation by using prearranged signals.
- Be observant. Plan to be a good witness. Try to notice as much as possible about the robber. Make mental notes of the following:
  - The number of robbers.
  - The robber's physical characteristics, including: race, sex, age, height, weight, facial characteristics (head shape, color of hair, color of eyes, shape of eyes, nose and mouth, etc.) speech patterns (i.e., accents), scars, marks and/or deformities, right or left-handed.
  - The robber's clothing description
  - Any names used by the robbers
  - Any peculiarities exhibited by the robber (i.e., smelled of alcohol, appeared to be "high" on drugs, etc.).
  - Description of any weapons used. Try to notice barrel length, barrel color, color of grips, whether a pistol is automatic or a revolver.
  - If the robber uses a written note, try to place it out of sight to retain it as evidence.
  - After the robber has the product or money, offer to have employees and customers lie down instead of waiting for the robber to decide what to do, such as knocking you down or tying you up.

### Procedures After the Robbery

If the following procedures are adhered to after a robbery, the employee will be in a better position to provide information to assist law enforcement officers in arresting the perpetrator, and more importantly, in protecting the employee and innocent customers from harm. These are:

- Establish which personnel will take certain actions if a robbery occurs. Decide now which employee will lock the doors, who will call the police, who will care for the injured, who will look



for the getaway car, who will protect the evidence, etc. Don't assume these jobs will be done automatically.

- Do not chase or follow the robber. The robber may shoot at any pursuers or the police may shoot at you, too, thinking you are a robber.
- Secure the doors so the robbers cannot reenter the facility. Stop business operations and place a sign on the door advising employees or customers that the facility is "Temporarily closed due to an emergency." Do not let anyone in, except emergency personnel.
- Call the police immediately. Be sure to tell them if anyone is injured so they may dispatch medical personnel if necessary. Give the police the time of the robber's departure, their description and direction and method of travel. Stay on the telephone until they tell you its okay to hang up. The speed of reporting is critical to the apprehension of the offender.
- Care for any injured people.
- If it can be safely accomplished as the robbers leave, try to note their method of escape along with the direction of travel. If a vehicle is used, try to find out the make, color, type, license number and the state of registration.
- Try to preserve any potential evidence. Protect the scene of the crime and do not touch anything the robber may have touched. Keep people out of the area.
- Write down the description of the robber. Witness description forms can be available to fill descriptive data and other remarks or if not available, use any available paper. Do not "compare notes" with others until a police officer arrives and conducts the necessary interviews.
- Ask witnesses to remain until the police arrive. If they insist on leaving, try to obtain their names and addresses.
- Contact any other individuals who may need to be contacted (i.e. owners, security, etc.). Emergency telephone numbers should be accessible, and the notification policy clearly established.
- Do not discuss the crime with outsiders until police give permission to do so. Refer all questions to the police.
- Do not tell or estimate how much product or money was lost to the robber unless absolutely necessary. The police can list the amount taken as an "undetermined amount of product and/or cash" until the exact amount is determined in an audit. Find out and record anything else that may have been stolen. If an exact amount of product and/or cash taken during the robbery should be released to the media and they report a large loss, other robbers could be attracted to the business or others in the chain. Do not speak to the media.
- Assist the investigating officers in every way possible. Cooperate with the police by being available for interviews, not being reluctant to identify suspects and giving evidence in court when notified to do so.



# Louie's Gouie's

## Injury & Illness Prevention Plan

DRAFT Copy

*Prepared June 19, 2018*



# Table of Contents

Illness Prevention and Safety Commitment..... 3

Injury and Illness Prevention Program ..... 4

Illness Prevention Policies [RESERVED] ..... 5

SAMPLE FORMS ..... 6

IIPP SAFETY REPRESENTATIVE DESIGNATION FORM..... 7

ACKNOWLEDGEMENT OF RECEIPT AND REVIEW OF CODE OF SAFE PRACTICES ..... 8

SAFETY RULE VIOLATION NOTICE ..... 9

WORKPLACE SAFETY SUGGESTIONS FORM..... 10

MANAGERS AND SUPERVISOR SAFETY MEETING REPORT..... 11



## Illness Prevention and Safety Commitment

GTS Management (“the Company”) is firmly committed to a safety policy enabling all work activities to be carried out safely, and with all possible measures taken to remove (or at least reduce) risks to the health, safety and welfare of workers, contractors, authorized visitors, and anyone else who may be affected by our operations.

The following safety policy manual is provided to assist Louie’s Gouie’s and employees in complying with the requirements of the company’s safety policy and CAL OSHA, as well as to provide other helpful information. It is not intended to supersede the requirements of the standards.

This manual demonstrates the commitment of The Company to both management and employee health and safety. Louie’s Gouie’s aims to remove or reduce the risks to the health, safety and welfare of all workers, contractors and visitors, and anyone else who may be affected by our business operations. The goal is to ensure all work activities are done safely.

Management (the supervisor and / or manager) is responsible for providing and maintaining:

- A safe working environment
- Safe systems of work
- Plants and substances in safe condition
- Facilities for the welfare of all workers
- Any information, instruction, training and supervision needed to make sure that all workers are safe from injury and risks to their health

Employees are responsible for:

- Ensuring their own personal health and safety, and that of others in the workplace
- Complying with any reasonable directions (such as safe work procedures, wearing personal protective equipment (PPE) given by management for health and safety

CEO/President \_\_\_\_\_(signature) 3



## Injury and Illness Prevention Program

### Safety Policy Statement

- It is the policy of Louie's Gouie's or ("the Company") that injury and illness prevention will be considered of primary importance in all phases of operation and administration.
- It is the intention of the company's top management to provide safe and healthy working conditions and to establish and insist upon safe practices at all times by all employees.
- The prevention of injury and illness is an objective affecting all levels of the organization and its activities. It is therefore, a basic requirement that each supervisor make the safety of employees an integral part of his or her regular management function. It is equally the duty of each employee to accept and follow established safety regulations and procedures.
- Every effort will be made to provide adequate training to employees. However, if an employee is ever in doubt how to do a job safely, it is their duty to ask a qualified person for assistance.
- Employees are expected to assist management in injury and illness prevention activities. Unsafe conditions must be reported. Fellow employees that need help should be assisted. Everyone is responsible for the housekeeping duties that pertain to their jobs.
- Any injury that occurs on the job, even a slight cut or strain, must be reported to management as soon as possible. In no circumstance, except emergency, should an employee leave a shift without reporting an injury that occurred.
- The company motto regarding injury and illness prevention is: "When you have an injury and illness, everyone loses; you, your family, your fellow workers, and the company. Please work safely. It's good for everyone."



## **Illness Prevention Policies [RESERVED]**

Louie's Gouie's will continue to develop its Illness Prevention Plan as the Company grows and takes on staff and functionality, with a continually reflective and improving system of processes and procedures that address all necessary areas of concern. Upon completion of the Company framework and licensure, Management will be focused on the development of the following policies and related procedures, per State and local requirements:

- ✚ Accountability for Jobsite Safety
- ✚ IIPP Safety Representative Duties and Responsibilities
- ✚ Jobsite Subcontractors and Supplies Safety and Responsibilities
- ✚ Jobsite Employees Safety and Responsibilities
- ✚ Owners, and Other Jobsite Visitors Safety and Responsibilities
- ✚ Employee and Subcontractor Compliance
  - Positive Recognition for Workers Who Follow Safe Jobsite Practices
- ✚ Code of Safe Practices
  - General Office
- ✚ Code of Safe Practices
  - General Jobsite
- ✚ Use of Tools and Equipment
- ✚ Machinery and Vehicles
- ✚ Driver Safety Procedure:
- ✚ Disciplinary Action for Safety Violators
- ✚ Safety Communication Policy





## **SAMPLE FORMS**



## IIPP SAFETY REPRESENTATIVE DESIGNATION FORM

The person with the authority and responsibility for our company Injury and Illness Prevention Program (IIPP) is \_\_\_\_\_. Whenever and wherever appropriate, \_\_\_\_\_, as the IIPP Safety Representative, may delegate safety-related duties to managers, supervisors or lead, or to any jobsite workers.

In addition to the above, the IIPP Safety Representative will see to it that the Company managers and supervisors will assume their respective responsibility for the safety and health of their assigned staff. Those responsibilities will include, but will not be limited to:

- Review safety policies and procedures; become familiar with functions and responsibilities of supervision, and the interrelationships with other departments.
- Develop a sound technical knowledge of all applicable Cal/OSHA Safety Orders and Regulations; in addition to keeping current with requirements made by other government agencies.
- Maintain an occupational training program covering hazards basic to all types of employment and those unique to each worker's job assignment.
- Correct unsafe and unhealthy work practices in a timely manner.
- Schedule and conduct regular safety training meetings with all employees.
- Perform first-aid duties as required, which will include maintaining appropriate first-aid supplies, dissemination of emergency procedures and providing first-aid training.
- Keep records of all employee training, corrections of unsafe conditions, dates and results of workplace inspections. Submit all documentation to Human Resources for company recordkeeping.



## ACKNOWLEDGEMENT OF RECEIPT AND REVIEW OF CODE OF SAFE PRACTICES

To all employees:

Attached is a copy of the code of safe practices. These guidelines are provided for your safety. It is the responsibility of Safety Representative to provide and review this code with each employee. It is the employee's responsibility to read and comply with this code. The attached copy of the code of safety practices are for you to keep. Please sign and date below and return this page to your manager or supervisor.  
I have read and understand the code of safe practices.

\_\_\_\_\_  
Employee Signature

\_\_\_\_\_  
Date



## SAFETY RULE VIOLATION NOTICE

Date of safety violation \_\_\_\_\_  
Worker's involved in the violation \_\_\_\_\_  
Employee's Company \_\_\_\_\_  
Company safety rule(s) violated \_\_\_\_\_  
Corrective action taken by Superintendent \_\_\_\_\_  
This is this employee's (first) (second) (third) (fourth) safety violation.  
Disciplinary action suggested \_\_\_\_\_  
Employee's Signature \_\_\_\_\_ Date \_\_\_\_\_  
Manager's Signature \_\_\_\_\_ Date \_\_\_\_\_  
Copy to employee (yes) (no) Date presented \_\_\_\_\_



## WORKPLACE SAFETY SUGGESTIONS FORM

Use this form to report any hazards you see, or to make any suggestions about improving safety in the facility. You need not sign this form if you do not want to. However, only signed forms are eligible for safety suggestion awards.

Submitted by (Optional) \_\_\_\_\_ Company \_\_\_\_\_

I have noticed the following safety/health hazard(s): \_\_\_\_\_

Location of the problem: \_\_\_\_\_

I have the following suggestion(s) for correcting the above-mentioned hazard(s), or for improving safety in this facility:

Reviewed by \_\_\_\_\_ on (date) \_\_\_\_\_



## MANAGERS AND SUPERVISOR SAFETY MEETING REPORT

Jobsite Name \_\_\_\_\_

Location \_\_\_\_\_

Date \_\_\_\_\_ Meeting Coordinator \_\_\_\_\_

Lessons to be learned from recent accidents and near misses: \_\_\_\_\_

Unresolved issues from the last walk-thru safety inspection: \_\_\_\_\_

New safety suggestions: \_\_\_\_\_

Recommended action taken: \_\_\_\_\_

Employees in attendance:

_____	_____
_____	_____
_____	_____
_____	_____
_____	_____

Guests:

_____	_____
_____	_____

Report reviewed by: \_\_\_\_\_ Date: \_\_\_\_\_



Fire Suppression & Safety Plan - DRAFT

Prepared for

Louie's Gouie's

316 Yolanda Avenue

Santa, Rosa CA

APN #044-072-005





## Table of Contents

- I. Policy Statement
- II. Authority and Scope
- III. Plan Administration
- IV. Plan Review and Update
- V. Definitions
- VI. Major Fire Hazards, Potential Ignition Sources, Controls, and Fire Control Equipment
- VII. Housekeeping
- VIII. Maintenance of Ignition Sources
- IX. Maintenance of Fire Prevention and Suppression Systems and Equipment
- X. Employee Training
- XI. Fire Evacuation Procedures
- XII. Recordkeeping



## Fire Prevention Plan

### I. Policy Statement

**Louie's Gouie's ("the Company")** will provide its employees and other personnel with a clear plan to prevent the loss of life and property by fire. The plan will comply with applicable fire prevention regulations.

### II. Authority and Scope

**Regulation:** 29 CFR 1910.39, Fire Prevention Plans.

**Scope:** This plan covers all work operations at Louie's Gouie's where fire hazards or the potential for fires may be present. This FPP provides all facility personnel with basic information about major fire hazards and fire prevention methods in accordance with federal and state regulations and company policy.

### III. Plan Administration

Table below provides the roles and contact information for the administration of the FPP.

**Table —Plan Contact Information**

Task	Contact Person	Contact Information
FPP Administrator	Operations Manager	Work: Mobile: TBD
Fuel Source Control	Operations Manager	Work: Mobile:TBD
Ignition Source Maintenance	Operations Manager	Work: Mobile:TBD
Fire Control Equipment	Operations Manager	Work: Mobile:TBD
Housekeeping	Operations Manager	Work: Mobile:TBD
Employee Training	Operations Manager	Work: Mobile:TBD
Emergency Services	Operations Manager Licensee	Work: Mobile:TBD

**FPP Administrator.** The FPP administrator is responsible for all elements of the FPP and has the authority to make necessary decisions to ensure its implementation. The administrator will periodically audit the FPP as necessary to ensure its effectiveness.

#### Operations Manager



- Has access to the controls for all fuel sources at the facility and is responsible for disconnecting them during an emergency;
- Maintains ignition source equipment to ensure that such equipment is operating properly;
- Is responsible for the inspection and maintenance of fire control equipment;
- Is responsible for controlling the accumulation of flammable and combustible waste materials;
- Is responsible for training employees to understand and implement the elements of the FPP;
- Is responsible for providing emergency services.

#### **IV. Plan Review and Update**

The FPP will be reviewed annually, and updated when:

- New hazards are identified and or existing hazards change.
- There are changes to the fire protection systems.
- There are changes to fire prevention procedures.

#### **V. Definitions**

*Exit*—the portion of an exit route that is generally separated from other areas to provide a protected way of travel to the exit discharge. An example of an exit is a 2-hour fire resistance-rated enclosed stairway that leads from a designated floor of an office building to the outside of the building.

*Exit route*—a continuous and unobstructed path of exit travel from any point within a workplace to a place of safety (including refuge areas). An exit route consists of three parts: the exit access; the exit; and the exit discharge. (An exit route includes all vertical and horizontal areas along the route.)

*Fire Hazard* - include all types of live flames, causes of sparks, hot objects, and chemicals that are potential for ignition, or that can aggravate a fire to become large and uncontrolled. Fire hazards also include all types of potential threats to fire prevention practices, firefighting, built-in fire safety systems and situations that restrict the escape of people from an affected building or area in the event of a fire.

#### **VI. Major Fire Hazards, Potential Ignition Sources, Controls, and Fire Control Equipment**

Table below contains a list of the major workplace fire hazards and potential ignition sources at the facility, their proper handling/storage and control procedures, and the fire protection equipment or systems used to prevent, control, or extinguish fires.



**Table —Fire Hazards, Sources, and Fire Control**

<b>Fuel Source Hazard</b>	<b>Ignition Source Hazard</b>	<b>Handling/Storage/ Control Procedure</b>	<b>Fire Protection System/Equipment</b>
<i>gases, chemicals, oily rags, office trash, combustible wastes, frayed electrical cords</i>	<i>smoking, electrical equipment, chemicals, gases, hot work (welding, etc.), flame-producing equipment]</i>	<i>no smoking, no hot work, ventilation, closed containers, chemical segregation,</i>	<i>sprinklers, smoke detectors, fire extinguishers (A, B, C), fire alarm and monitoring system</i>
<i>dried plants and leaves</i>	<i>fire sparks</i>	<i>no smoking, no hot work, no frayed electrical cords, no mixing of chemicals without proper safety training</i>	<i>sprinklers, smoke detectors, fire extinguishers (A, B, C), fire alarm and monitoring system</i>
<i>Chemicals and gases</i>	<i>fire sparks, chemical reaction from mixing chemicals</i>	<i>no smoking, no hot work, no frayed electrical cords, no mixing of chemicals without proper safety training</i>	<i>sprinklers, smoke detectors, fire extinguishers (A, B, C), fire alarm and monitoring system</i>
<i>Electrical Outlet Overload</i>	<i>electric sparks and fire</i>	<i>do not overload electrical outlets</i>	<i>sprinklers, smoke detectors, fire extinguishers (A, B, C), fire alarm and monitoring system</i>

### VII. Housekeeping

- Flammable and combustible materials and residues will be controlled so that they do not cause or contribute to a fire emergency. See Table above for a list of fuel source hazards and fire prevention measures. This list is not all inclusive.
- All chemicals must be stored in the proper sealed labeled containers in the assigned storage area. Chemicals are not to be mixed without the appropriate safety training.
- All work areas must be kept clean and orderly with no garbage, papers, waste products, open combustible chemicals, spills must be cleaned according to SDS sheet manual.
- Electrical cords must be in good condition and must not be an electrical or trip and fall hazard.
- Employees may not leave open chemical containers.
- Employees must clean and organize their work areas prior to leaving at the end of the work day.

### VIII. Maintenance of Ignition Sources

Equipment and systems installed on heat- or ignition-producing equipment and processes will be maintained to prevent the accidental ignition of flammable and combustible materials. See Table above for a list of ignition-source hazards and fire prevention measures.

#### **Extension cords.**



Electric extension cords will be inspected before each use and kept in good condition. Employees will not yank cords from electrical outlets. Tools and equipment that require grounding will be of the three-wire grounded-connection type. Never use extension cords to replace permanent wiring. If an extension cord is used for temporary wiring, it must be listed by Underwriters Laboratories or another recognized testing laboratory. Avoid kinking or excessive bending of the cord; broken strands may pierce the insulated covering and become a shock or short-circuit hazard.]

## **IX. Maintenance of Fire Prevention and Suppression Systems and Equipment**

Fire prevention and suppression systems and equipment will be inspected and cleaned **monthly** by a designated contractor under the supervision of the Operations Manager or Master Grower.

## **X. Employee Training**

Training for employees about the FPP will be provided:

- New Hire Orientation and onboarding
- At the time of initial work assignment
- Whenever new fire hazards are introduced into a work area
- Whenever employees are transferred to a new work area

Training topics will include:

- The fire hazards of the materials and processes to which employees are exposed
- Procedures for controlling the accumulations of flammable and combustible materials, including material handling and storage
- Applicable elements of the hazard communication program
- Emergency Evacuation Plan & Meeting Site

## **XI. Fire Evacuation**

Training for fire evacuation will be conducted on a quarterly basis. Employees, visitors, customers and anyone on the company premises will be required to leave the facility in the event of a fire, earthquake or any other emergency situation. They will be required to use the fire exits that are labeled with red exit signs, and to use stairs and not the elevator (if one is in building).

Employees, visitors, customers and anyone on the premises will be required to meet at the designated meeting area outside of the facility. Everyone must leave all purses and personal effects behind and must evacuate as soon as the alarm sounds. Employees are prohibited from leaving the meeting site until they have been accounted for and with the permission of management. Employees are not allowed into the facility without approval from the fire department.





## **XII. Recordkeeping**

A record of FPP training for employees will be maintained at the Louie's Gouie's facility with sign off forms indicating each employee's participation in the program. A Draft Safety Policy and Procedure Manual is attached and will be further developed along with the other administrative tools as we approach the state licensing phase.

**LOUIE'S GOUIE'S  
VEHICLE & DRIVERS SAFETY POLICY**





## Policy

It is the policy of Louie's Gouie's that our vehicles (including vans and light-duty trucks) will be used only for company business and will be operated only by authorized persons who meet the driver criteria in our vehicle safety program.

The purpose of this Policy is to ensure the safety of employees who drive company vehicles. Vehicle accidents are costly to our company, but more importantly, they may result in injury to you or others. It is the driver's responsibility to operate all vehicles in a safe manner and to drive defensively to prevent injuries and property damage. As such the Louie's Gouie's endorses all applicable state motor vehicle regulations relating to driver responsibility. Louie's Gouie's expects each driver to drive in a safe and courteous manner pursuant to the following safety rules. The attitude you take when behind the wheel is the single most important factor in driving safely.

## Driver Eligibility

Every delivery driver shall meet the following requirements:

- a) Drivers must be at least 21 years of age.
- b) Drivers must provide proof of automobile insurance at the time of hire and every six (6) months thereafter.
- c) Drivers must have a satisfactory driving record.
- d) Drivers are required to complete a Delivery Driver Application and receive a Delivery Driver badge (in addition to an Employment Application and completing a background investigation, if one is not already on file.
- e) Been issued an ID Badge by the Chief of Police indicating they are an approved delivery driver.
- f) A delivery driver shall only conduct deliveries on behalf of one registered collective during their shift.
- g) Hold a valid unexpired California Driver's License appropriate for the class of vehicle he or she will be driving.
- h) Have completed a background investigation by the Chief of Police that includes a driver's license review.
- i) Have in their possession during deliveries:
  1. California driver's license.
  2. Police department issued ID Badge indicating that they are an approved delivery driver.
  3. Vehicle's registration and proof of required insurance.
  4. Copy of the collective's Notice of Completed Registration.
  5. Present those documents to any Peace Officer or City official enforcing this code upon request.
  6. The delivery driver shall at all times during deliveries carry an operating cell phone to connect with the collective or emergency services as needed.
- j) Be a member of the registered collective.



## **Driver Policies and Procedures**

- Company vehicles are to be driven by authorized employees ONLY, except in emergencies, or in case of repair testing by a mechanic. Other employees and family members are not authorized to drive the Company vehicle.
- Company vehicles are to be driven for Company Business ONLY. Personal use of company vehicles is prohibited. No unauthorized persons are allowed to ride in company vehicles.
- Any employee who has his or her driver's license revoked or suspended shall immediately notify their Manager or Supervisor and discontinue operation of the company vehicle. Failure to do so may result in disciplinary action up to and including termination of employment.
- All accidents involving Company vehicles, regardless of severity, must be immediately reported to the police and to the driver's Manager and Licensee. Failing to stop after an accident and/or failure to report an accident may result in disciplinary action and up to and including termination of employment.
- The use of a company vehicle while under the influence of alcohol, intoxicants and other drugs is forbidden and is sufficient cause for discipline up to and including termination of employment.
- All drivers and authorized passengers while operating or riding in company vehicles must wear seat belts.
- Report any mechanical difficulties or repair needs immediately to dispatch and the driver's manager or supervisor.
- Drivers are responsible for the security of Company vehicles being used by them. The vehicle engine must be shut off, ignition keys removed, and vehicle doors locked whenever the vehicle is left unattended.

## **Driving Records**

Your personal driving record is a reflection of your overall driving habits, and directly affects our insurance costs. Your personal driving is your responsibility and our concern.

Motor Vehicle Records will be ordered every 6 months or as needed to assess driving records. An unfavorable record will result in the loss of company vehicle driving privileges.

## **Cell phone Usage**

- Under all circumstances, employees shall obey all motor vehicle laws. Violations or fines incurred by employees shall be the full responsibility of the employee and may



affect future driving privileges with Louie's Gouie's.

- California and Louie's Gouie's prohibits the use of a cell phone while driving. Texting is forbidden. Dialing out should be done only from a safely parked position.



- Hands-free cellular phones are subject to the same policy as the hand-held cellular phones. (No dialing out, texting, or interfering with safe operation of the vehicle).





## EMPLOYEE AUTHORIZATION FOR MVR REVIEW

I acknowledge that the information contained in the Louie's Gouie's's Driver Safety Policy has been reviewed with me, and a copy of the policy and driver rules have been furnished to me. As a driver of a company vehicle, I understand that it is my responsibility to operate the vehicle in a safe manner and to drive defensively to prevent injuries and property damage.

I also understand that my employer will periodically review my Motor Vehicle Record to determine continued eligibility to drive a company vehicle. In accordance with the Fair Credit Reporting Act, I have been informed that a Motor Vehicle Record will be periodically obtained on me for continued employment purposes.

I acknowledge the receipt of the above disclosure and authorize my employer or its designated agent to obtain a Motor Vehicle Record report. This authorization is valid as long as I am an employee or employee candidate and may only be rescinded in writing.

EMPLOYEE'S NAME (PRINT) \_\_\_\_\_ DATE \_\_\_\_\_

DRIVER'S LICENSE NUMBER \_\_\_\_\_ EXPIRATION DATE \_\_\_\_\_

EMPLOYEE SIGNATURE \_\_\_\_\_ DATE \_\_\_\_\_

REVIEWER'S SIGNATURE \_\_\_\_\_ DATE \_\_\_\_\_

REVIEWER'S NAME (PRINT) \_\_\_\_\_



# Delivery Driver Requirements

- Must have a valid Driver's License
- Must be at least 21 years of age in accordance with Federal Labor Laws
- Must have at least 2 years of U.S. Driving Experience
- NEW DMW/MVR report every 6 months
- Drivers must maintain insurance at all times on their vehicles
- Each vehicle operated during the course of business must have a completed Nine Point Strategies Vehicle Inspection form. Each completed form is reviewed by the carriers for acceptability. **(Substitution vehicles are not permitted without proper evidence of insurance on the auto and the vehicle inspection form is completed.)**
- Drivers may qualify with up to 2 Minor Violations within the last 36 months
- Drivers may qualify with 1 At-Fault Accident and 1 Minor Violation within the last 36 months
- No Major Violations in the past 5 years. Major Violation include, but not limited to:
  - Driving under the influence of drugs or alcohol
  - Reckless Driving
  - Hit & Run
  - Speed Contest
  - Driving with suspended/revoked license
  - Eluding a police officer
- **CA Only: Distracted Driving (i.e. Cell Phone Use, or texting violations. Any distracted driving violation cited after 10/01/2012 will now be counted as a Major Violation.**



## Prohibited Mobile Device

The drivers are prohibited from using their mobile device while driving in both the drivers requirements and the employment agreement. If they ever violate the rule, they will immediately be fired!

## Steps for checking Medical Marijuana 1st time patient:

1. After receiving a call from a first time patient we require them to send us a copy of both their license and medical prescription by Text, Email, or Verification through our site online.
2. Once we receive the copies for our files, we make sure both forms are identical in name and picture.
3. Then we verify their prescription by phone or online depending Louie's Gouie's. We always try online first since it's faster.

### Online:

1. With 420evaluation.com, I enter the patients # and DOB.
  2. It will say expired or not a current patient, if not verified.
  3. If it is current, it will give you the patients full name and the date of their expiration.
  4. I then make sure the full name is identical.
4. Once they are verified we call them back and are able to take their order. We place their information into our database that will notify use when their prescription expires. Otherwise they are good to order until their expiration date.
5. We check both the California ID and Prescription at the door before completing the transaction. This is done on every transaction to be sure the right person receives their prescription.

## **Steps for checking Medical Marijuana 1st time patient:**



## **Steps for checking Recreation Marijuana 1st time patient:**

1. After receiving a call from a first time patient we require them to send us a copy of their license by Text or Email.
2. Once we receive the copy we make sure they are over 21 and have a valid State ID.
3. We store it in our files and check it at the door before completing the transaction. We check everytime we deliver to make sure the right person is receiving the product.



# EMPLOYEE HANDBOOK

## LOUIE'S GOUIES





## Table of Contents

<u>General Employment Policies</u> .....	6
Introductory Statement.....	7
Harassment Discrimination and Retaliation Prevention .....	8
Confirmation of Harassment Discrimination and Retaliation Prevention Policy .....	12
At-Will Employment Status.....	13
Right to Revise .....	14
<u>Hiring</u> .....	15
Full-Time Employees .....	<b>Error! Bookmark not defined.</b>
Inactive Status.....	17
Job Duties.....	17
New Hires .....	17
Part-Time Employees.....	16
Regular Employees.....	16
Temporary Employees .....	16
<u>Leaves of Absence</u> .....	18
Bereavement Leave .....	19
Domestic Violence, Sexual Assault or Stalking Leave and Accommodation .....	19
Extended Medical Leave.....	20
Jury Duty and Witness Leave .....	20
Military Leave .....	21
Pregnancy Disability Leave Five or More Employees.....	21
School Appearances Involving Suspension .....	23
Sick Leave .....	23
Time Off for Voting .....	24
Vacation.....	25
Victims of Crime Leave .....	25



Volunteer Civil Service Personnel .....26

Benefits .....27

    Benefits Overview .....28

    Holidays.....28

    Lactation Policy .....28

    Paid Family Leave.....29

    Workers' Compensation .....29

Management.....31

    Employee Property.....32

    Employment of Relatives .....32

    Names and Addresses Policy.....32

    Open-Door Policy .....32

    Performance Evaluations .....33

    Personnel Records.....33

    Telecommuting ..... **Error! Bookmark not defined.**

    Workplace Privacy - Audio/Video Recordings.....34

Company Property.....35

    Bulletin Boards .....36

    Electronic and Social Media.....36

    Employer Property.....39

    Prohibiting Personal Use of Company Cell Phone.....40

    Smoking.....40

    Solicitation and Distribution of Literature .....40

Employee Conduct.....41

    Conducting Personal Business .....42

    Confidential Information .....42

    Conflicts of Interest.....42



Customer Relations.....	43
Dress Codes and Other Personal Standards .....	43
Drug and Alcohol Abuse .....	44
News Media Contacts .....	45
Off-Duty Conduct.....	45
Other Employment .....	45
Political Activity.....	45
Prohibited Conduct.....	46
Prohibited Use of Company Cell Phone While Driving.....	47
Punctuality and Attendance .....	47
<u>Wages</u> .....	49
Advances .....	<b>Error! Bookmark not defined.</b>
Deductions for Exempt Employees.....	50
Expense Accounts .....	50
Meal and Rest Periods.....	51
Overtime for Nonexempt Employees.....	53
Payment of Wages .....	53
Recruitment Bonus.....	54
Timekeeping Requirements .....	54
<u>Safety and Health</u> .....	55
Employees Who Are Required to Drive .....	56
Ergonomics.....	56
Fragrance Policy .....	56
Health and Safety.....	56
Recreational Activities and Programs.....	57
Security.....	57
Workplace Violence .....	57
<u>Termination</u> .....	59



Employee References.....60

Involuntary Termination and Progressive Discipline .....60

Reductions in Force .....60

Voluntary Resignation .....60

Confirmation of Receipt .....61

Confirmation of Receipt.....62





## **General Employment Policies**



## Introductory Statement

Welcome! As an employee of Organic Care (the "Company"), you are an important member of a team effort. We hope that you will find your position with the Company rewarding, challenging, and productive.

Because our success depends upon the dedication of our employees, we are highly selective in choosing new members of our team. We look to you and the other employees to contribute to the success of the Company.

This employee handbook is intended to explain the terms and conditions of employment of all full- and part-time employees. Written employment contracts between Organic Care and some individuals may supersede some of the provisions of this handbook.

This handbook summarizes the policies and practices in effect at the time of publication. This handbook supersedes all previously issued handbooks and any policy or benefit statements or memoranda that are inconsistent with the policies described here. Your supervisor or manager will be happy to answer any questions you may have.



## Harassment Discrimination and Retaliation Prevention

Organic Care (“the Company”) is an equal opportunity employer. Organic Care is committed to providing a work environment free of harassment, discrimination, retaliation, and disrespectful or other unprofessional conduct based on sex (including pregnancy, childbirth, breastfeeding or related medical conditions), sex stereotype, race, religion (including religious dress and grooming practices), color, gender (including gender identity, gender expression and transgender), national origin (including language use restrictions and possession of a driver's license issued under Vehicle Code section 12801.9), ancestry, physical or mental disability, medical condition, genetic information, marital status, registered domestic partner status, age, sexual orientation, military and veteran status or any other basis protected by federal, state or local law or ordinance or regulation. It also prohibits discrimination, harassment, disrespectful or unprofessional conduct based on the perception that anyone has any of those characteristics or is associated with a person who has or is perceived as having any of those characteristics.

In addition, the Company prohibits retaliation against individuals who raise complaints of discrimination or harassment or who participate in workplace investigations.

**All such conduct violates Company policy.**

### Harassment Prevention

The Company's policy prohibiting harassment applies to all persons involved in the operation of the Company. The Company prohibits harassment, disrespectful or unprofessional conduct by any employee of the Company, including supervisors, managers and co-workers. The Company's anti-harassment policy also applies to vendors, customers, independent contractors, unpaid interns, volunteers, persons providing services pursuant to a contract and other persons with whom you come into contact while working.

Prohibited harassment, disrespectful or unprofessional conduct includes, but is not limited to, the following behavior:

- Verbal conduct such as epithets, derogatory jokes or comments, slurs or unwanted sexual advances, invitations, comments, posts or messages;
- Visual displays such as derogatory and/or sexually-oriented posters, photography, cartoons, drawings or gestures;
- Physical conduct including assault, unwanted touching, intentionally blocking normal movement or interfering with work because of sex, race or any other protected basis;
- Threats and demands to submit to sexual requests or sexual advances as a condition of continued employment, or to avoid some other loss and offers of employment benefits in return for sexual favors;
- Retaliation for reporting or threatening to report harassment; and
- Communication via electronic media of any type that includes any conduct that is prohibited by state and/or federal law or by company policy.



Sexual harassment does not need to be motivated by sexual desire to be unlawful or to violate this policy. For example, hostile acts toward an employee because of his/her gender can amount to sexual harassment, regardless of whether the treatment is motivated by sexual desire.

Prohibited harassment is not just sexual harassment but harassment based on any protected category.

### **Non-Discrimination**

The Company is committed to compliance with all applicable laws providing equal employment opportunities. This commitment applies to all persons involved in Company operations. The Company prohibits unlawful discrimination against any job applicant, employee or unpaid intern by any employee of the Company, including supervisors and coworkers.

Pay discrimination between employees of the opposite sex or between employees of another race or ethnicity performing substantially similar work, as defined by the California Fair Pay Act and federal law, is prohibited. Pay differentials may be valid in certain situations defined by law. Employees will not be retaliated against for inquiring about or discussing wages. However, Organic Care is not obligated to disclose the wages of other employees.

### **Anti-Retaliation**

The Company will not retaliate against you for filing a complaint or participating in any workplace investigation or complaint process, and will not tolerate or permit retaliation by management, employees or co-workers.

### **Reasonable Accommodation**

Discrimination can also include failing to reasonably accommodate religious practices or qualified individuals with disabilities where the accommodation does not pose an undue hardship.

To comply with applicable laws ensuring equal employment opportunities to qualified individuals with a disability, the Company will make reasonable accommodations for the known physical or mental limitations of an otherwise qualified individual with a disability who is an applicant or an employee unless undue hardship would result.

Any job applicant or employee who requires an accommodation in order to perform the essential functions of the job should contact a Company representative with day-to-day personnel responsibilities and discuss the need for an accommodation. The Company will engage in an interactive process with the employee to identify possible accommodations, if any, that will help the applicant or employee perform the job. An applicant, employee or unpaid intern who requires an accommodation of a religious belief or practice (including religious dress and grooming practices, such as religious clothing or hairstyles) should also contact a Company representative with day-to-day personnel responsibilities and discuss the need for an



accommodation. If the accommodation is reasonable and will not impose an undue hardship, the Company will make the accommodation.



The Company will not retaliate against you for requesting a reasonable accommodation and will not knowingly tolerate or permit retaliation by management, employees or co-workers.

### **Complaint Process**

If you believe that you have been the subject of harassment, discrimination, retaliation or other prohibited conduct, bring your complaint to your supervisor or to:

- Any other Company supervisor or Manager
- The office manager or owner(s) of Organic Care
- The president
- Another designated Company representative

as soon as possible after the incident. You can bring your complaint to any of these individuals. If you need assistance with your complaint, or if you prefer to make a complaint in person, contact one of the individuals listed above. Please provide all known details of the incident or incidents, names of individuals involved and names of any witnesses. It would be best to communicate your complaint in writing, but this is not mandatory.

The Company encourages all individuals to report any incidents of harassment, discrimination, retaliation or other prohibited conduct forbidden by this policy immediately so that complaints can be quickly and fairly resolved.

You also should be aware that the Federal Equal Employment Opportunity Commission and the California Department of Fair Employment and Housing investigate and prosecute complaints of prohibited harassment, discrimination and retaliation in employment. If you think you have been harassed or discriminated against or that you have been retaliated against for resisting, complaining or participating in an investigation, you may file a complaint with the appropriate agency. The nearest office can be found by visiting the agency websites at [www.dfeh.ca.gov](http://www.dfeh.ca.gov) and [www.eeoc.gov](http://www.eeoc.gov).

Supervisors or Managers must refer all complaints involving harassment, discrimination, retaliation or other prohibited conduct to the owner(s) or President of the Company so the Company can try to resolve the complaint.

When the Company receives allegations of misconduct, it will immediately undertake a fair, timely, thorough and objective investigation of the allegations in accordance with all legal requirements. The Company will reach reasonable conclusions based on the evidence collected.

The Company will maintain confidentiality to the extent possible. However, the Company cannot promise complete confidentiality. The employer's duty to investigate and take corrective action may require the disclosure of information to individuals with a need to know.

Complaints will be:

- Responded to in a timely manner





- Kept confidential to the extent possible



- Investigated impartially by qualified personnel in a timely manner
- Documented and tracked for reasonable progress
- Given appropriate options for remedial action and resolution
- Closed in a timely manner

If the Company determines that harassment, discrimination, retaliation or other prohibited conduct has occurred; appropriate and effective corrective and remedial action will be taken in accordance with the circumstances involved. The Company also will take appropriate action to deter future misconduct.

Any employee determined by the Company to be responsible for harassment, discrimination, retaliation or other prohibited conduct will be subject to appropriate disciplinary action, up to, and including termination. Employees should also know that if they engage in unlawful harassment, they can be held personally liable for the misconduct.



## Confirmation of Harassment Discrimination and Retaliation Prevention Policy

I have received my copy of the ORGANIC CARE ("the Company") Harassment, Discrimination and Retaliation Prevention policy. I understand and agree that it is my responsibility to read and familiarize myself with this policy.

I understand that the Company is committed to providing a work environment that is free from harassment, discrimination and retaliation. My signature certifies that I understand that I must conform to and abide by the rules and requirements described in this policy.

Employee's Signature \_\_\_\_\_

Employee's Printed Name \_\_\_\_\_

Date \_\_\_\_\_



## **At-Will Employment Status**

Organic Care personnel are employed on an at-will basis. Employment at-will means that the employment relationship may be terminated, with or without cause and with or without advance notice at any time by the employee or the Company. Nothing in this handbook shall limit the right to terminate at-will employment.

No manager, supervisor, or employee of the Company has any authority to enter into an agreement for employment for any specified period of time or to make an agreement for employment on other than at-will terms. Only the owner(s) or President of Organic Care has the authority to make any such agreement, which is binding only if it is in writing.

Nothing in this at-will statement is intended to interfere with an employee's rights to communicate or work with others toward altering the terms and conditions of his or her employment.



## Right to Revise

This employee handbook contains the employment policies and practices of Organic Care in effect at the time of publication. All previously issued handbooks and any inconsistent policy statements or memoranda are superseded.

Organic Care reserves the right to revise, modify, delete, or add to any and all policies, procedures, work rules, or benefits stated in this handbook or in any other document, except for the policy of at-will employment. However, any such changes must be in writing and must be signed by the owner(s) or the President of ORGANIC CARE.

Any written changes to this handbook will be distributed to all employees so that employees will be aware of the new policies or procedures. No oral statements or representations can in any way alter the provisions of this handbook.

This handbook sets forth the entire agreement between you and Organic Care as to the duration of employment and the circumstances under which employment may be terminated. Nothing in this employee handbook or in any other personnel document, including benefit plan descriptions, creates or is intended to create a promise or representation of continued employment for any employee.

Nothing in this at-will statement is intended to interfere with an employee's rights to communicate or work with others toward altering the terms and conditions of his or her employment.



## **Hiring**





## Regular Employees

Regular employees are those who are hired to work on a regular schedule. Regular employees may be classified as full-time or part-time.

## Part-Time Employees

Part-time employees are those who are scheduled for and do work fewer than 30 hours per week, but not fewer than 20 hours. Part-time employees are eligible for the following Organic Care benefits:

- Sick leave

## Temporary or Seasonal Employees

Temporary or Seasonal employees are those employed for short-term assignments. Short-term assignments generally are periods of three months or fewer; however, such assignments may be extended. Temporary or Seasonal employees are not eligible for employee benefits except those mandated by applicable law.



## Inactive Status

Employees who are on any type of leave of absence, work-related or non-work-related, that exceeds any protected state or federal leave of absence will be placed on inactive status.

### Health Benefits Extension

Unless health benefits extension is covered by state or federal law, benefits will terminate according to our insurance carrier's policy. Contact your supervisor or manager for more information.

## Job Duties

During the introductory period, your supervisor will explain your job responsibilities and the performance standards expected of you. Be aware that your job responsibilities may change at any time during your employment. From time to time, you may be asked to work on special projects, or to assist with other work necessary or important to the operation of your department or Organic Care. Your cooperation and assistance in performing such additional work is expected.

Organic Care reserves the right, at any time, with or without notice, to alter or change job responsibilities, reassign or transfer job positions, or assign additional job responsibilities.

## New Hires

Completion of the introductory period does not entitle you to remain employed by Organic Care for any definite period of time. Your status as an at-will employee does not change. The employment relationship may be terminated with or without cause and with or without advance notice, at any time by you or the Company.

The first 90 days of continuous employment at Organic Care is considered an introductory period. During this time, you will learn your responsibilities, get acquainted with fellow employees and determine whether or not you are happy with your job. Your supervisor will closely monitor your performance.



## **Leaves of Absence**



## **Bereavement Leave**

Organic Care grants leave of absence to employees in the event of the death of the employee's current spouse, registered domestic partner, child, parent, legal guardian, brother, sister, grandparent, or grandchild; or mother-, father-, sister-, brother-, son-, or daughter-in-law. An employee with such a death in the family may take up to 3 days consecutive scheduled workdays off without pay with the approval of the Company. The employee's supervisor may approve additional unpaid time off.

## **Domestic Violence, Sexual Assault or Stalking Leave and Accommodation**

Employees who are victims of domestic violence, sexual assault and stalking are eligible for unpaid leave. Although the leave is generally unpaid, employees can use their paid sick time under California's Healthy Workplaces, Healthy Families Act for the purposes described below.

You may request leave if you are involved in a judicial action, such as obtaining restraining orders, or appearing in court to obtain relief to ensure your health, safety or welfare, or that of your child. Please provide reasonable advance notice of the need for leave unless advance notice is not feasible. Contact your manager or supervisor.

Employees who are victims of domestic violence, sexual assault or stalking and need a reasonable accommodation for their safety at work should contact a manager or Company representative with day-to-day personnel responsibilities and discuss the need for an accommodation. If you are requesting such a reasonable accommodation, you will need to submit a written statement signed by you, or by an individual acting on your behalf, certifying that the accommodation is for the purpose of your safety at work.

For reasonable accommodation requests, the Company will also require certification demonstrating that you are the victim of domestic violence, sexual assault or stalking. Any of the forms of certification described above for leave purposes will suffice. The Company may request recertification every six months from the date of the previous certification. You should notify the company if an approved accommodation is no longer needed.

The Company will engage in an interactive process with the employee to identify possible accommodations, if any, that are effective and will make reasonable accommodations unless an undue hardship will result.

Organic Care will, to the extent allowed by law, maintain the confidentiality of an employee requesting leave or accommodation under these provisions.



## Extended Medical Leave

A medical leave of absence may be granted for non-work-related medical disabilities (other than pregnancy, childbirth, and related medical conditions) with a doctor's written certificate of disability. Extended disability leaves will also be considered on a case-by-case basis, consistent with the Company's obligations under federal and state disability laws.

Employees should request any leave in writing as far in advance as possible. If you are granted a medical leave, Organic Care will pay you sick pay for the period of time equivalent to your accumulated sick pay earned.

A medical leave begins on the first day your doctor certifies that you are unable to work and ends when your doctor certifies that you are able to return to work. Your supervisor or manager will supply you with a form for your doctor to complete, showing the date you were disabled and the estimated date you will be able to return to work. An employee returning from a medical disability leave must present a doctor's certificate declaring fitness to return to work.

If returning from a non-work-related medical leave, you will be offered the same position you held at the time your leave began, if available. If your former position is not available, a comparable position will be offered. If neither the same nor a comparable position is available, your return to work will depend on job openings existing at the time of your scheduled return. Organic Care makes no guarantees of reinstatement, and your return will depend on your qualifications for existing openings.

California workers' compensation laws govern work-related injuries and illnesses. California pregnancy disability laws govern leaves taken because of pregnancy, childbirth, and related medical conditions. An employee that needs reasonable accommodations should contact a company representative with day-to-day personnel responsibilities and discuss the need for an accommodation.

## Jury Duty and Witness Leave

Organic Care encourages employees to serve on jury duty when called. Organic Care does not offer jury duty pay at this time. You should notify your supervisor of the need for time off for jury duty as soon as a notice or summons from the court is received. You may be requested to provide written verification from the court clerk of performance of jury service. If work time remains after any day of jury selection or jury duty, you will be expected to return to work for the remainder of your work schedule.

### Fees Paid by the Court

You may retain any mileage allowance or other fee paid by the court for jury services.

## Military Leave

Employees who wish to serve in the military and take military leave should contact their manager or supervisor for information about their rights before and after such leave. You are entitled to reinstatement upon completion of military service, provided you return or apply for reinstatement within the time allowed by law.

## Pregnancy Disability Leave Five or More Employees

If you are pregnant, have a related medical condition, or are recovering from childbirth, please review this policy. Any employee planning to take pregnancy disability leave should advise the personnel department as early as possible. The individual should make an appointment with their manager or supervisor to discuss the following conditions:

- Duration of pregnancy disability leave will be determined by the advice of the employee's physician, but employees disabled by pregnancy may take up to four months of unpaid leave per pregnancy (the working days you normally would work in one-third of a year or 17 1/3 weeks). Part-time employees are entitled to leave on a pro rata basis. The four months of leave includes any period of time for actual disability caused by the employee's pregnancy, childbirth, or related medical condition. This includes leave for severe morning sickness and for prenatal care, doctor-ordered bed rest, as well as other reasons. Your healthcare provider determines how much time you need for your disability.
- Organic Care will also reasonably accommodate medical needs related to pregnancy, childbirth, or related conditions or temporarily transfer you to a less strenuous or hazardous position (where one is available) or duties if medically needed because of your pregnancy.
- Employees who need to take pregnancy disability must inform Organic Care when a leave is expected to begin and how long it will likely last. If the need for a leave, reasonable accommodation, or transfer is foreseeable (such as the expected birth of a child or a planned medical treatment for yourself), employees must provide at least 30 days advance notice before the pregnancy disability leave or transfer is to begin. Employees must consult with their manager regarding the scheduling of any planned medical treatment or supervision in order to minimize disruption to the operations of the Company. Any such scheduling is subject to the approval of the employee's health care provider;
- For emergencies or events that are unforeseeable, we need you to notify the Company, at least verbally, as soon as practical after you learn of the need for the leave.
- Failure to comply with these notice requirements may result in delay of leave, reasonable accommodation, or transfer;
- Pregnancy leave usually begins when ordered by the employee's physician. The employee must provide Organic Care with a written certification from a health care provider for need of PDL, reasonable accommodation or transfer. The certification must be returned no later than 15 calendar days after it is requested by the Company. Failure to do so may, in some circumstances, delay PDL leave, reasonable accommodation or transfer. Please see the personnel department for a medical certification form to give to your health provider.





- Leave returns will be allowed only when the employee's physician sends a release;



- An employee will be allowed to use accrued sick time (if otherwise eligible to take the time) during a pregnancy disability leave.
- Leave does not need to be taken in one continuous period of time and may be taken intermittently, as needed. Leave may be taken in increments of 4 hours.

If intermittent leave or leave on a reduced work schedule is medically advisable the employee may, in some instances, be required to transfer temporarily to an available alternative position that meets the employee's needs. The alternative position need not consist of equivalent duties, but must have the equivalent rate of pay and benefits. The employee must be qualified for the position. The position must better accommodate the employee's leave requirements than her regular job. Transfer to an alternative position can include altering an existing job to better accommodate the employee's need for intermittent leave or a reduced work schedule.

Upon submission of a medical certification that an employee is able to return to work from a pregnancy disability leave, an employee will be reinstated to her same position held at the time the leave began or, in certain instances, to a comparable position, if available. There are limited exceptions to this policy. An employee returning from a pregnancy disability leave has no greater right to reinstatement than if the employee had been continuously employed.

Employees on pregnancy disability leave will be allowed to continue to participate in group health insurance coverage for up to a maximum of four months of disability leave (if such insurance was provided before the leave was taken) at the level and under the conditions that coverage would have been provided if the employee had continued in employment continuously for the duration of the leave. In some instances, an employer can recover from an employee premiums paid to maintain health coverage if the employee fails to return following pregnancy disability leave. PDL may impact other benefits or a seniority date. Please contact your manager or supervisor for more information.



## School Appearances Involving Suspension

If an employee who is the parent or guardian of a child facing suspension from school is summoned to the school to discuss the matter, the employee should alert his or her supervisor as soon as possible before leaving work. In agreement with California Labor Code Section 230.7, no discriminatory action will be taken against an employee who takes time off for this purpose.

## Sick Leave

California law provides for mandatory paid sick leave under the Healthy Workplaces, Healthy Families Act (the "Act"). This paid sick leave policy is intended to comply with the requirements of the Act.

Employees cannot be discriminated or retaliated against for requesting or using accrued paid sick time.

If you have any questions about paid sick leave, please contact your manager or supervisor .

### Eligible Employees

Beginning July 1, 2015, all employees who have worked in California for the same employer for 30 or more days within a year from the start of their employment will be entitled to paid sick time.

**However, employees are not eligible to take paid sick time until they have worked for the Company for 90 days from their date of hire.**

### Sick Pay Amount

Eligible employees will receive sick leave as follows:

#### Employees hired after July 1, 2015:

Organic Care will provide eligible employees with three days or 24 hours of paid sick time on their first day of employment with Organic Care. You will need to meet the 90 day employment requirement before taking any leave.

*Unused paid sick time will not carry over from year to year.* However, Organic Care will place three days or 24 hours of paid sick time into your leave bank each year on your anniversary date. Employees will be able to access all three days or 24 hours of paid sick time at the beginning of each 12-month period.

The Company does not pay employees for unused paid sick time at the time of termination.



## **Qualifying Reasons for Paid Sick Leave**

Paid sick time can be used for the following reasons:

- Diagnosis, care or treatment of an existing health condition for an employee or covered family member, as defined below.
- Preventive care for an employee or an employee's covered family member.
- For certain, specified purposes when the employee is a victim of domestic violence, sexual assault or stalking.

For purposes of paid sick leave, a covered family member includes:

- A child defined as a biological, foster or adopted child; a stepchild; or a legal ward, regardless of the age or dependency status of the child. A "child" also may be someone for whom you have accepted the duties and responsibilities of raising, even if he or she is not your legal child.
- A "parent" defined as a biological, foster or adoptive parent; a stepparent; or a legal guardian of an employee or the employee's spouse or registered domestic partner. A parent may also be someone who accepted the duties and responsibilities of raising you when you were a minor child, even if he or she is not your legal parent.
- A spouse.
- A registered domestic partner.
- A grandparent.
- A grandchild.
- A sibling.

## **Use of Paid Sick Leave**

If the need for paid sick leave is foreseeable, employees shall provide advance oral or written notification to the supervisor or manager. If the need for paid sick leave is not foreseeable, employees shall provide notice to the supervisor or manager as soon as practicable.

An employee's use of paid sick time may run concurrently with other leaves under local, state or federal law.

Paid sick leave can be used in four (4) hours hour increments.

## **Time Off for Voting**

If an employee does not have sufficient time outside of working hours to vote in an official state-sanctioned election, the employee may take off enough working time to vote. Such time off shall be taken at the beginning or the end of the regular working shift, whichever allows for more free time, and the time taken off shall be combined with the voting time available outside of working hours to a maximum of two hours combined. Under these circumstances, an employee



will be allowed a maximum of two hours of time off during an election day without loss of pay.



When possible, an employee requesting time off to vote shall give his or her supervisor at least a two days notice.

## Vacation

### Vacation Accrual Introductory Period

Regular full-time employees may accrue paid vacations in accordance with the following policy:

Temporary and part-time employees do not accrue paid vacation time. Regular full-time employees do not accrue vacation time during the first six months of employment. No vacation time may be taken until after completion of the first year of employment.

After completion of the initial six months of continuous employment, full-time employees begin to accrue vacation time at the rate of 3.33 per month. An employee who is scheduled to and does work 40 hours per week will normally accrue five working days or 40 hours of vacation in the second six months of continuous employment.

The Company encourages employees to take vacation annually. Vacation time must be taken within the year following accrual. Earned vacation time accrues to a maximum of forty (40) hours..

No additional vacation will be earned until accrued vacation time is used. Employees are responsible for tracking their accrued vacation time.

An employee whose employment terminates will be paid for accrued unused vacation days on a pro rata basis. Vacations shall be scheduled to provide adequate coverage of job responsibilities and staffing requirements. The general manager or manager will make final determinations and must approve your vacation schedule in advance.

## Victims of Crime Leave

An employee who is themselves a victim or who is the family member of a victim of certain serious crimes may take time off from work to attend judicial proceedings related to the crime or to attend proceedings involving rights of the victim.

A family member of a crime victim may be eligible to take this leave if he/she is the crime victim's spouse, parent, child or sibling. Other family members may also be covered depending on the purpose of the leave.

The absence from work must be in order to attend judicial proceedings or proceedings involving rights of the victim. Only certain crimes are covered. You must provide reasonable advance notice of your need for leave, and documentation related to the proceeding may be required. If advance notice is not possible, you must provide appropriate documentation within a reasonable time after the absence.

Any absence from work to attend judicial proceedings or proceedings involving victim rights will be unpaid.





For more information regarding this leave (including whether you are covered, when and what



type of documentation is required, and which type of paid time off can be used), please contact your manager or supervisor with day-to-day personnel responsibilities.

### **Volunteer Civil Service Personnel**

No employee shall be disciplined for taking time off to perform emergency duty as a volunteer firefighter, peace officer, or emergency rescue personnel. Employees who perform emergency duty as a volunteer firefighter, reserve peace officer, or emergency rescue personnel may also take up to a total of fourteen days unpaid leave time per calendar year to engage in required fire, law enforcement or emergency rescue training. Please alert your supervisor that you may have to take time off for emergency duty or emergency duty training. When taking time off for emergency duty, please alert your supervisor before doing so when possible.



## **Benefits**



## Benefits Overview

Organic Care is committed to providing the following benefits for eligible employees. Benefit eligibility may be dependent upon your employee classification (full-time versus part-time, for example) and on length of continuous employment at ORGANIC CARE. Benefit eligibility requirements may also be imposed by the plans themselves.

Upon becoming eligible for certain employee benefit plans, you will receive a Summary Plan Descriptions which describe the benefits in greater detail. For information regarding employee benefits and to answer any questions you may have contact your manager or supervisor.

The Company reserves the right to modify, amend or terminate benefits and to modify or amend benefit eligibility requirements at any time and for any reason, subject to any legal restrictions.

The Company offers the following employee benefits:

- Health Insurance
- Dental Insurance

## Holidays

For the 2018 calendar year, Organic Care observes the following paid holidays:

- January 1 (New Year's Day)
- July 4th (Independence Day)
- Thanksgiving Day and the Friday after
- Christmas Eve
- Christmas Day

When a holiday falls on a Saturday or Sunday, it is usually observed on the preceding Friday or the following Monday. However, Organic Care may grant another day off in lieu of closing. Holiday observance will be announced in advance.

Each non-exempt employee's eligibility for holiday pay begins after completion of his or her introductory period. To be eligible for holiday pay, you must be regularly scheduled to work on the day on which the holiday is observed and must work your regularly scheduled working days immediately preceding and immediately following the holiday, unless an absence on either day is approved in advance by your supervisor or the absence is otherwise protected by law. If you are required to work on a paid scheduled holiday you will receive double time.

## Lactation Policy

Organic Care accommodates lactating employees by providing a reasonable amount of break time to any employee who desires to express breast milk for an infant child. The break time shall, if possible, run concurrently with any break time already provided to the employee. Any



break time provided to express breast milk that does not run concurrently with break time



already provided to the employee shall be unpaid. However, if providing such break time would seriously disrupt the operations of our business, we may deny break time to employees who wish to express breast milk.

We will make reasonable efforts to provide employees who need a lactation accommodation with the use of a room or other private location that is located close to the employee's work area. Employees with private offices will be required to use their offices to express breast milk.

Employees who desire lactation accommodations should contact their supervisor or Human Resources to request accommodations.

Discrimination on the basis of sex includes discrimination based on breastfeeding and related medical conditions and is unlawful.

## Paid Family Leave

Employees may be eligible for Paid Family Leave (PFL) wage replacement benefits, which are funded through payroll deductions and coordinated through the Employment Development Department. PFL provides limited compensation for up to six weeks after an unpaid, seven-day waiting period when an employee needs to take leave from work to care for a parent, parent-in-law, child, spouse, registered domestic partner, grandparent, grandchild, or sibling who is seriously ill, or for a working parent who wants time to bond with his or her newborn, foster child or newly adopted child. The PFL program does not provide employees with a right to a leave of absence; it is limited to a state-mandated wage replacement benefit.

## Workers' Compensation

Organic Care, in accordance with state law, provides insurance coverage for employees in case of work-related injury. The workers' compensation benefits provided to injured employees may include:

- Medical care;
- Cash benefits, tax free, to replace lost wages; and
- Assistance to help qualified injured employees return to suitable employment.

To ensure that you receive any workers' compensation benefits to which you may be entitled, you will need to:

- Immediately report any work-related injury to your supervisor;
- Seek medical treatment and follow-up care if required;
- Complete a written *Employee's Claim for Workers' Compensation Benefits* (DWC Form 1) and return it to your manager or supervisor; and
- Provide the Company with a certification from your health care provider regarding the need for workers' compensation disability leave, as well as your eventual ability to return to work from the leave.





Upon submission of a medical certification that an employee is able to return to work after a workers' compensation leave, the employee under most circumstances will be reinstated to his or her same position held at the time the leave began, or to an equivalent position, if available. An employee returning from a workers' compensation leave has no greater right to reinstatement than if the employee had been continuously employed rather than on leave. For example, if the employee on workers' compensation leave would have been laid off had he or she not gone on leave, or if the employee's position has been eliminated or filled in order to avoid undermining the Company's ability to operate safely and efficiently during the leave, and no equivalent or comparable positions are available, then the employee would not be entitled to reinstatement.

An employee's return depends on his or her qualifications for any existing openings. If, after returning from a workers' compensation disability leave, an employee is unable to perform the essential functions of his or her job because of a physical or mental disability, the Company's obligations to the employee may include reasonable accommodation, as governed by the Americans with Disabilities Act.

The law requires Organic Care to notify the workers' compensation insurance company of any concerns of false or fraudulent claims.

### **Company-Provided Physician**

Organic Care provides medical treatment for work-related injuries through a medical provider network, which the company has chosen to provide medical care to injured employees because of their experience in treating work-related injuries.



## **Management**



## Employee Property

An employee's personal property, including but not limited to lockers, packages, purses, and backpacks, may be inspected upon reasonable suspicion of unauthorized possession of Organic Care property, possession of dangerous weapons or firearms, or abuse of the Company's drug and alcohol policy.

## Employment of Relatives

Relatives of employees may be eligible for employment with Organic Care only if individuals involved do not work in a direct supervisory relationship, or in job positions in which there is a conflict of interest. The Company defines "relatives" as spouses, registered domestic partners, children, siblings, parents, in-laws, and step-relatives. Present employees who marry or become registered domestic partners will be permitted to continue working in the job position held only if they do not work in a direct supervisory relationship with one another or in job positions involving conflict of interest.

## Names and Addresses Policy

Organic Care is required by law to keep current all employees' names and addresses. Employees are responsible for notifying the Company in the event of a name or address change.

## Open-Door Policy

Suggestions for improving Organic Care are always welcome. At some time, you may have a complaint, suggestion, or question about your job, your working conditions, or the treatment you are receiving. Your complaints, questions, and suggestions also are of concern to the Company.

If you have a complaint, suggestion or question, speak with your immediate supervisors as soon as possible. If you are not comfortable speaking to your immediate supervisor, please bring the issue to any other member of management.

Moreover, if you have raised the issue and if the problem persists, you may present it to the owner(s) who will investigate and provide a solution or explanation.

If the problem is not resolved, you may also present the problem to the owner(s) or president of Organic Care, who will attempt to reach a final resolution.

While a written complaint will assist us in investigating your concerns, it is not required that you put your complaint in writing. If you need assistance with your complaint, or you prefer to make a complaint in person, contact a member of management.

This procedure, which we believe is important for both you and the Company, cannot guarantee that every problem will be resolved to your satisfaction. However, Organic Care values your observations and you should feel free to raise issues of concern without the fear of retaliation.



## Performance Evaluations

Each employee will receive periodic performance reviews conducted by his or her supervisor. Your first performance evaluation will take place six months after your date of hire. Subsequent performance evaluations will be conducted anniversary date. The frequency of performance evaluations may vary depending upon length of service, job position, past performance, changes in job duties, or recurring performance problems.

Your performance evaluations may review factors such as the quality and quantity of the work you perform, your knowledge of the job, your initiative, your work attitude, and your attitude toward others. The performance evaluations are intended to make you aware of your progress, areas for improvement, and objectives or goals for future work performance. Favorable performance evaluations do not guarantee increases in salary or promotions. Salary increases and promotions are solely within the discretion of Organic Care and depend upon many factors in addition to performance. After the review, you will be required to sign the evaluation report simply to acknowledge that it has been presented to you, that you have discussed it with your supervisor, and that you are aware of its contents.

## Personnel Records

You have a right to inspect or receive a copy of the personnel records that Organic Care maintains relating to your performance or to any grievance concerning you. Certain documents may be excluded or redacted from your personnel file by law, and there are legal limitations on the number of requests that can be made.

Any request to inspect or copy personnel records must be made in writing to your manager or supervisor. You can obtain a form for making such a written request from your manager or supervisor.

You may designate a representative to conduct the inspection of the records or receive a copy of the records. However, any designated representative must be authorized by you in writing to inspect or receive a copy of the records. Organic Care may take reasonable steps to verify the identity of any representative you have designated in writing to inspect or receive a copy of your personnel records.

The personnel records may be made available to you either at the place where you work or at a mutually agreeable location (with no loss of compensation for going to that location to inspect or copy the records). The records will be made available no later than 30 calendar days from the date Organic Care receives your written request to inspect or copy your personnel records (unless you/your representative and Organic Care mutually agree in writing to a date beyond 30 calendar days but no later than 35 calendar days from receipt of the written request).

If you request a copy of the contents of your file, you will be charged the actual cost of copying.

Disclosure of personnel information to outside sources, other than your designated representative, will be limited. However, Organic Care will cooperate with request from authorized law enforcement or local, state, or federal agencies conducting official investigations and as otherwise legally required.



## Workplace Privacy - Audio/Video Recordings

Due to concerns regarding the potential for invasion of privacy, sexual or other harassment, and protection of proprietary or confidential information, employees may not use any audio or video recording devices while on working time. Employees also may **not** use any audio or video recordings in work areas that Organic Care has identified as confidential, secure or private, unless the employee is engaged in protected activity related to improving the terms and conditions of his/her employment, such as documenting health and safety issues.



## **Company Property**





## Bulletin Boards

Organic Care maintains bulletin boards located offices.

Bulletin boards are used to provide information to employees concerning company related announcements.

Employees may not post items on Company bulletin boards unless the following conditions are met:

- Postings may be made by Company employees only;
- The information to be posted must first be approved by your manager or supervisor.
- Postings are limited to 8.5" x 11" in size;
- Bulletin boards will be updated monthly; and
- Posted items will be dated and will be removed after one month.

## Electronic and Social Media

This policy is intended to protect the Company's computer systems and electronic information.

For purposes of these policies, the following definitions apply: "Computers" are defined as desktop computers, laptops, handheld devices (including but not limited to iPhones, Black berries, smart phones, iPads, and other electronic tablets and cell phones), computer software/hardware and servers, and .

Organic Care also uses various forms of "electronic communication." "Electronic communications" includes e-mail, text messages, telephones, cell phones and other handheld devices (such as cell phones, Blackberries or smart phones or writing tablets or iPads), fax machines, and online services including the Internet.

"Electronic information" is any information created by an employee using computers or any means of electronic communication, including but not limited to, data, messages, multimedia data, and files.

The following general policies apply:

- Computers and all data transmitted through Organic Care servers are Company property owned by the Company for the purpose of conducting Company business. These items must be maintained according to Organic Care rules and regulations. Computers must be kept clean and employees must exercise care to prevent loss and damage. Prior authorization must be obtained before any Company property may be removed from the premises.
- All electronic communications also remain the sole property of Organic Care and are to be used for Company business. For example, email messages are considered Company records.



- Electronic information created by an employee using any computer or any means of



electronic communication is also the property of Organic Care and remains the property of Organic Care.

- Information stored in Organic Care computers and file servers, including without limitation Customer lists, vendor lists, research data, company proprietary information is the property of the Company and may not be distributed outside the Company in any form whatsoever without the written permission of the owner(s) or President.
- Violation of any of the provisions of this policy, whether intentional or not, will subject Organic Care employees to disciplinary action, up to and including termination.

### **Monitoring of Company Property**

Organic Care reserves the right to inspect all Company property to ensure compliance with its rules and regulations, without notice to the employee and at any time, not necessarily in the employee's presence. Organic Care computers and all electronic communications and electronic information are subject to monitoring and no one should expect privacy regarding such use. The Company reserves the right to access, review and monitor electronic files, information, messages, text messages, e-mail, Internet history, browser-based webmail systems and other digital archives and to access, review and monitor the use of computers, software, and electronic communications to ensure that no misuse or violation of Company policy or any law occurs. E-mail may be monitored by the Company and there is no expectation of privacy. Assume that e-mail may be accessed, forwarded, read or heard by someone other than the intended recipient, even if marked as "private."

Employee passwords may be used for purposes of security but the use of a password does not affect the Company's ownership of the electronic information or ability to monitor the information. The Company may override an employee's password for any reason.

Employees are not permitted to access the electronic communications of other employees or third parties unless directed to do so by Organic Care management.

### **Prohibited Use**

All existing Company policies apply to employee use of computers, electronic communications, electronic information, and the Internet. This includes policies that deal with misuse of Company assets or resources. It is a violation of Organic Care policy to use computers, electronic communications, electronic information, or the Internet, in a manner that: is discriminatory harassing or obscene; constitutes copyright or trademark infringement; violates software licensing rules; is illegal; or is against Organic Care policy. It is also a violation of policy to use computers, electronic communications, electronic information, or the Internet to communicate confidential or sensitive information or trade secrets.

The display of any kind of sexually explicit multimedia content, message, or document on any Company computer is a violation of the Company's policy against sexual harassment. This description of prohibited usage is not exhaustive and it is within the discretion of Organic Care to determine if there has been a violation of this policy. Employees that engage in prohibited use will be subject to discipline and/or immediate termination.



This policy is not intended to limit the ability of employees to discuss with other employees the



terms and conditions of their employment, including such topics as wages, job performance, workload, supervisors, or staffing.

### **Computer and Internet Use**

Organic Care provides computers, electronic communications, electronic information, and information technology resources, including the Internet, to its employees to help them do their job. Generally, these Company resources should be used for business related purposes. However, the Company recognizes that occasional personal use of these Company resources and property may occur during working time. The Company allows such occasional personal use as long as the usage does not interfere with the employee's work performance, take away from work time, consume supplies, slow other users, slow the servers or computer systems, or tie up printers or other shared resources, or violate any Company policy, including policies against harassment, discrimination and disclosure of confidential or trade secret information.

This policy is not intended to limit the ability of employees to use Company email systems to communicate with other employees regarding the terms and conditions of their employment, including such topics as wages, job performance, workload, supervisors or staffing.

All policies relating to monitoring usage of Company property apply. Organic Care reserves the right to adjust this policy on a case by case basis as it deems appropriate.

### **Social Media**

Social media is a set of Internet tools that aid in the facilitation of interaction between people online. If you have specific questions about which programs the Company deems to be social media, consult with the owner(s) or President. The Company recognizes that occasional personal use of social media using Company resources may occur during working hours. The Company allows such occasional personal use as long as the usage does not interfere with the employee's work performance, take away from work time, consume supplies, slow other users, slow the servers or computer systems, or tie up printers or other shared resources, or violate any Company policy, including policies against harassment, discrimination and disclosure of confidential or trade secret information. All policies relating to monitoring usage of Company property apply. Organic Care reserves the right to adjust this policy on a case by case basis as it deems appropriate.

Employees can use their own personal devices to engage in social media during breaks and meal periods; however, all other company policies against inappropriate usage, including the Company's no tolerance for discrimination, harassment or retaliation in the workplace, and protection of confidential or trade secret information, apply.

Nothing in the Company's social media policy is designed to interfere with, restrain or prevent employee communications regarding wages, hours or other terms and conditions of employment.

### **Employee-owned Devices**



Organic Care recognizes that occasional use of the employee's own computers (including hand





held devices) and electronic communications may occur during working time. The Company allows such occasional personal use as long as the usage does not interfere with the employee's work performance, take away from work time or violate any Company policy. All other company policies, including the Company's no tolerance for discrimination, harassment or retaliation in the workplace apply. Organic Care reserves the right to adjust this policy on a case by case basis as it deems appropriate.

## Employer Property

Lockers, furniture, desks, computers, cell phones, data processing equipment/software, vehicles, and are Organic Care property and must be maintained according to Company rules and regulations. They must be kept clean and are to be used only for work-related purposes. Organic Care reserves the right to inspect all Company property including computer or phone data or messages to ensure compliance with its rules and regulations, without notice to the employee and at any time, not necessarily in the employee's presence. Prior authorization must be obtained before any Company property may be removed from the premises.

Company voice mail and/or electronic mail (e-mail) including texting, pagers and mobile email are to be used for business purposes. Organic Care reserves the right to monitor voice mail messages, and e-mail messages, and texts to ensure compliance with this rule, without notice to the employee and at any time, not necessarily in the employee's presence.

Organic Care may periodically need to assign and/or change "passwords" and personal codes for

- email
- voice mail
- computers
- cell phones

These communication technologies and related storage media and databases are to be used only for Company business and they remain the property of Organic Care.

Organic Care reserves the right to keep a record of all passwords and codes used and/or may be able to override any such password system. Messages on the company voice-mail and email systems are subject to the same company policies against discrimination and harassment as are any workplace communications. Offensive, harassing or discriminatory content in such messages will not be tolerated.

For security reasons, employees should not leave personal belongings of value in the workplace. Terminated employees should remove any personal items at the time they leave Organic Care. Personal items left in the workplace are subject to disposal if not claimed at the time of an employee's termination.



## Prohibiting Personal Use of Company Cell Phone

Cell phones (including handheld devices and smart phones such as iPhones) may be provided to some employees to assist them in performing their job. Cell phones are company property. Data (including web browsing), messages (including voice mail, mobile email, and text messaging), and other stored electronic information is subject to monitoring and the employee does not have an expectation of privacy in the use of this Company property.

The Company may ask you to assign a password to your Company cell phone to prevent unauthorized access. This password does not affect the Company's ownership of the cell phone or ability to monitor the information.

Company cell phones must not be used in any manner that violates any other Company policy, including safety policies, confidentiality policies, electronic and social media policies, and policies against discrimination and harassment.

Employees who are provided a Company cell phone may use it to send and receive occasional and limited personal communications. Any personal usage of a Company-issued cell phone must not interfere with the employee's work performance, take away from work time, or violate any Company policy, including policies against harassment, discrimination and disclosure of confidential or trade secret information. Employees are responsible for paying for additional time or data usage in excess of any rate plan maintained by the Company and unrelated to performance of job duties or following Company directions.

## Smoking

Smoking is strictly prohibited at this workplace. The smoking prohibition applies to all smoking devices, including, but not limited to, the use of electronic smoking devices, such as electronic cigarettes, pipes, hookahs, and vaping devices. Smoking is only allowed in the designated smoking areas.

## Solicitation and Distribution of Literature

In order to ensure efficient operation of the Company's business and to prevent disruption to employees, we have established control of solicitations and distribution of literature on Company property. Organic Care has enacted rules applicable to all employees governing solicitation, distribution of written material, and entry onto the premises and work areas. All employees are expected to comply strictly with these rules. Any employee who is in doubt concerning the application of these rules should consult with his or her supervisor.

No employee shall solicit or promote support for any cause or organization during his or her working time or during the working time of the employee or employees at whom such activity is directed. No employee shall distribute or circulate any written or printed material in work areas at any time, or during his or her working time or during the working time of the employee or employees at whom such activity is directed.

Under no circumstances will non-employees be permitted to solicit or to distribute written material for any purpose on Company property.



## **Employee Conduct**



## Conducting Personal Business

Employees are to conduct only Organic Care business while at work. Employees may not conduct personal business or business for another employer during their scheduled working hours.

## Confidential Information

**Each employee is responsible for safeguarding the confidential information obtained during employment.**

In the course of your work, you may have access to trade secrets or similarly protected proprietary or confidential information regarding Organic Care's business (such as financial data, research and development, marketing, business plans or strategies, suppliers, business partners or customers). You have a responsibility to prevent revealing or divulging any such information unless it is necessary for you to do so in the performance of your duties or as required by law.

Access to, or disclosure of, confidential information should be on a "need-to-know" basis and must be authorized by your supervisor. Any breach of this policy will not be tolerated and legal action may be taken by the Company.

This policy does not prohibit employees from confidentially disclosing trade secret, proprietary or confidential information to federal, state and local government officials, or to an attorney, when done to report or investigate a suspected violation of the law. Employees may also disclose the information in certain court proceedings if specific procedures to protect the information are followed. Nothing in this policy is intended to conflict with 18 U.S.C. sec. 1833(b) or create liability for disclosures of trade secrets that are expressly allowed by 18 U.S.C. sec. 1833(b).

## Conflicts of Interest

All employees must avoid situations involving actual conflict of interest. Personal or romantic involvement with a competitor, supplier, or subordinate employee of Organic Care, which impairs an employee's ability to exercise good judgment on behalf of the Company, can create an actual conflict of interest. Supervisor-subordinate romantic or personal relationships also can lead to supervisory problems, possible claims of sexual harassment, and morale problems.

An employee involved in any of the types of relationships or situations described in this policy should immediately and fully disclose the relevant circumstances to his or her immediate supervisor, or any other appropriate supervisor, for a determination about whether an actual conflict exists. If an actual conflict is determined, Organic Care may take whatever corrective action appears appropriate according to the circumstances. Failure to disclose facts shall constitute grounds for disciplinary action.



## Customer Relations

Employees are expected to be polite, courteous, prompt, and attentive to every customer. When an employee encounters an uncomfortable situation that he or she does not feel capable of handling, the general manager should be called immediately.

Ours is a service business and all of us must remember that the customer always comes first. Our customers ultimately pay all of our wages. Remember, while the customer is not always right, the customer is never wrong.

Customers are to be treated courteously and given proper attention at all times. Never regard a customer's question or concern as an interruption or an annoyance. You must respond to inquiries from customers, whether in person or by telephone, promptly and professionally.

Never place a telephone caller on hold for an extended period. Direct incoming calls to the appropriate person and make sure the call is received.

Through your conduct, show your desire to assist the customer in obtaining the help he or she needs. If you are unable to help a customer, find someone who can.

All correspondence and documents, whether to customers or others, must be neatly prepared and error-free. Attention to accuracy and detail in all paperwork demonstrates your commitment to those with whom we do business.

Never argue with a customer. If a problem develops or if a customer remains dissatisfied, ask your supervisor or the general manager to intervene.

## Dress Codes and Other Personal Standards

Employees are expected to wear clothing appropriate for the nature of our business and the type of work performed. Clothing should be neat, clean and tasteful. Avoid clothing that can create a safety hazard. Department managers may issue more specific guidelines.

Employees who need a reasonable accommodation because of religious beliefs, observances or practices should contact a company representative with day-to-day personnel responsibility and discuss the need for accommodation.

## Drug and Alcohol Abuse

Organic Care is concerned about the use of alcohol, marijuana, illegal drugs or controlled substances as it affects the workplace. Use of these substances, whether on or off the job can detract from an employee's work performance, efficiency, safety, and health, and seriously impair Company operations. In addition, the use or possession of these substances on the job constitutes a potential danger to the welfare and safety of other employees and exposes the Company to the risks of property loss or damage, or injury to other persons.

The following rules and standards of conduct apply to all employees while on Company property, at work, or working on Company business. The following are strictly prohibited by Company policy:

- Being under the influence of, or impaired by, an illegal or controlled substance, alcohol or marijuana while on the job.
- Using or possessing illegal or controlled substances, alcohol or marijuana while on the job (including the illegal use of prescription drugs and possessing drug paraphernalia)
- Distributing, selling, or purchasing of an illegal or controlled substance, alcohol or marijuana while on the job.

Violation of these rules and standards of conduct will not be tolerated. Organic Care also may bring the matter to the attention of appropriate law enforcement authorities.

In order to enforce this policy, Organic Care reserves the right to conduct searches of Company property or employees and/or their personal property, and to implement other measures necessary to deter and detect abuse of this policy.

An employee's conviction on a charge of illegal sale or possession of any controlled substance while off Company property will not be tolerated because such conduct, even though off duty reflects adversely on Organic Care. In addition, the Company must keep people who sell or possess controlled substances off Company premises in order to keep the controlled substances themselves off the premises.

Organic Care will encourage and reasonably accommodate employees with alcohol, marijuana or drug dependencies to seek treatment and/or rehabilitation. Employees desiring such assistance should request a treatment or rehabilitation leave. The Company is not obligated, however, to continue to employ any person whose performance of essential job duties is impaired because of drug, alcohol or marijuana use. Additionally, employees who are given the opportunity to seek treatment and/or rehabilitation, but fail to successfully overcome their dependency or problem, will not automatically be reemployed or be given a second opportunity to seek treatment and/or rehabilitation. This policy on treatment and rehabilitation is not intended to affect the Company's treatment of employees who violate the regulations described previously. Rather, rehabilitation is an option for an employee who acknowledges a chemical dependency and voluntarily seeks treatment to end that dependency.





## News Media Contacts

Employees may be approached for interviews or comments by the news media. Only contact people designated by the CEO may comment to news reporters on Organic Care policy or events relevant to Organic Care.

This policy does not limit an employee's right to discuss the terms and conditions of his or her employment, or to try and improve these conditions.

## Off-Duty Conduct

While Organic Care does not seek to interfere with the off-duty and personal conduct of its employees, certain types of off-duty conduct may interfere with the Company's legitimate business interests.

Off-duty conduct by an employee that directly conflicts with the Company's essential business interests and disrupts business operations will not be tolerated.

## Other Employment

While employed by Organic Care, employees are expected to devote their energies to their jobs with the Company.

Employment that directly conflicts with the Company's essential business interests and disrupts business operations is strictly prohibited.

Employees who wish to engage in additional employment that may create a real conflict of interest must submit a written request to Organic Care explaining the details of the additional employment. If the additional employment is authorized, Organic Care assumes no responsibility for it. Organic Care shall not provide workers' compensation coverage or any other benefit for injuries occurring from or arising out of additional employment. Authorization to engage in additional employment can be revoked at any time.

## Political Activity

Many employees participate in political activities on their own time. Company time, facilities, property or equipment (including all computers, networks, and electronic equipment) must not be used for an employee's outside political activities. Organic Care will not reimburse any employee for political contributions, and employees should not attempt to receive or facilitate such reimbursements.

Absent a formal statement by Organic Care announcing any political endorsements, employees must not, through their own actions, speech, contributions, or written communication, mislead others to believe that Organic Care officially endorses or opposes any candidates for political office that Organic Care itself has not publicly announced. Company employees are entitled to their own personal position.

The Company will not discriminate against employees based on their lawful political activity engaged in outside of work.

## Prohibited Conduct

Employees are expected to conduct themselves in a manner to further the Company's objectives. The following conduct is prohibited and will not be tolerated by Organic Care. This list of prohibited conduct is illustrative only; other types of conduct that threaten security, personal safety, employee welfare and Company operations also may be prohibited and will result in disciplinary action up to and including termination.

- Falsifying employment records, employment information, or other Company records;
- Inefficient or careless performance of job responsibilities or inability to perform job duties satisfactorily;
- Recording the work time of another employee or allowing any other employee to record your work time, or falsifying any time card, either your own or another employee's;
- Theft and deliberate or careless damage or destruction of any Company property, or the property of any employee or customer;
- Removing or borrowing Company property without prior authorization;
- Unauthorized use or misuse of Company equipment, time, materials, or facilities;
- Provoking a fight or fighting during working hours or on Company property;
- Participating in horseplay or practical jokes on Company time or on Company premises;
- Carrying firearms or any other dangerous weapons on Company premises at any time;
- Engaging in criminal conduct whether or not related to job performance;
- Causing, creating or participating in a disruption of any kind during working hours on Company property;
- Insubordination, including but not limited to failure or refusal to obey the orders or instructions of a supervisor or member of management, or the use of abusive or threatening language toward a supervisor or member of management;
- Using abusive, threatening or intimidating language at any time on Company premises;
- Violation of Company punctuality and attendance policies. Absences protected by state or federal law do not count as violations of this policy. Protected paid sick time under California law does not count as a violation of this policy;
- Failing to obtain permission to leave work for any reason during normal working hours, not including meal periods;
- Failing to observe working schedules, including rest and lunch periods;
- Sleeping or malingering on the job;
- Making or accepting personal telephone calls, including cell phone calls, of more than three minutes in duration during working hours, except in cases of emergency or extreme circumstances;
- Working overtime without authorization or refusing to work assigned overtime;
- Violation of dress standards;
- Violating any safety, health, security or Company policy, rule, procedure or violation of the Company's drug and alcohol policy;
- Committing a fraudulent act or a breach of trust under any circumstances;



- Violating the Company's anti-harassment or equal employment opportunity policies; and
- Failing to promptly report work-related injury or illness.

This statement of prohibited conduct does not alter the Company's policy of at-will employment. Either you or Organic Care remain free to terminate the employment relationship at any time, with or without reason or advance notice.

## **Prohibited Use of Company Cell Phone While Driving**

In the interest of the safety of our employees and other drivers, Organic Care employees are prohibited from using cell phones (including all smart phones) or other wireless communication devices (including laptops) while driving on Company business and/or Company time. This prohibition includes any use of the cell phone or other wireless communications device, such as answering or placing calls, engaging in conversations, texting, Web browsing or using any smart phone application while driving.

If your job requires that you keep your cell phone or other wireless communication device turned on while you are driving, you must use a hands-free, voice-operated device at all times. Under no circumstances should employees place phone calls while operating a motor vehicle while driving on Company business and/or Company time. Violating this policy is a violation of law and a violation of Company rules.

The prohibition would not apply to such a person using a wireless telephone or a mobile service device for emergency purposes. Violating this policy is a violation of law and a violation of Company rules.

Writing, sending, or reading text-based communication - including text messaging, instant messaging, e-mail, web browsing and use of smart phone applications - on a wireless device or cell phone while driving is also prohibited under this policy. Violating this policy is a violation of law and a violation of Company rules.

You must also safely pull off the road before conducting Company business.

## **Punctuality and Attendance**

As an employee of Organic Care, you are expected to be punctual and regular in attendance. Any tardiness or absence causes problems for your fellow employees and your supervisor. When you are absent, your assigned work must be performed by others.

Employees are expected to report to work as scheduled, on time, and prepared to start work. Employees also are expected to remain at work for their entire work schedule, except for meal periods or when required to leave on authorized Company business. Late arrivals, early departures or other unanticipated and unapproved absences from scheduled hours are disruptive and must be avoided.

If you are unable to report for work on any particular day, you must provide reasonable advance notice to your supervisor before the time you are scheduled to begin working for that day. You must inform your supervisor of the expected duration of any absence. If you fail to provide



reasonable advance notice before your scheduled time to begin work and do not arrive in time



for your assigned shift, you will be considered tardy for that day. If the circumstances for your tardiness or absence were unforeseen, inform your supervisor as soon as practicable of the reason for the tardiness or absenteeism.

Excessive absenteeism or tardiness, providing false information or abuse of leave laws will not be tolerated. Generally, if you fail to report for work without any notification to your supervisor and your absence continues for a period of 3 consecutive days, Organic Care will consider that you have voluntarily abandoned or quit your employment.

**Absences protected by local, state and federal law do not count as a violation of the punctuality and attendance policy. Paid sick time protected under California law does not count as a violation of this policy.**



## Wages





## Deductions for Exempt Employees

Employees paid on a "salary basis" regularly receive a predetermined amount of compensation each pay period. Subject to the exceptions listed below, exempt employees will receive full salary for any workweek in which they perform any work, regardless of the number of days or hours worked. Exempt employees may not be paid for any workweek in which they perform no work, subject to Organic Care benefits programs and policies.

No deductions from salary may be made for time when work is not available, provided the exempt employee is ready, willing, and able to work. Deductions from pay are permissible when an exempt employee:

- Is absent from work for one or more full days for personal reasons other than sickness or disability;
- Is absent for one or more full days due to sickness or disability if the deduction is made in accordance with a bona fide plan, policy, or practice of providing full compensation for salary lost due to illness and the employee has exhausted his or her leave under this policy;
- Is absent for jury duty or military duty for a full week and performs no work during the week; or
- Works less than a full week during the initial or final week of employment;

Partial day deductions from available accrued vacation or sick leave balances will also be made by the Company when applicable.

It is Company policy to comply with these salary basis requirements. Therefore, Organic Care prohibits all Company managers from making any improper deductions from the salaries of exempt employees. The Company wants employees to be aware of this policy and know that the Company does not allow deductions that violate federal or state law.

If you believe that an improper deduction from your salary has been made, you should immediately report this information to your direct supervisor, or to \_\_\_\_\_

Reports of improper deductions will be investigated promptly. If it is determined that an improper deduction has occurred, you will be promptly reimbursed for any improper deduction made.

## Expense Accounts

Organic Care reimburses employees for business expenses on the end of the month of each month. Employees who have expense accounts or who have incurred business expenses must submit required receipts and the Manager to Manager no later than the 25th of each month.

If you have any questions about the Company's expense reimbursement policy, contact Manager.



## Meal and Rest Periods

### Rest Breaks

All nonexempt employees are entitled to uninterrupted rest break periods during their workday. If you are a nonexempt employee, you will be paid for all such break periods, and you will not clock out.

### Number of Rest Breaks

You will be authorized and permitted one (1) 10-minute net rest break for every four (4) hours you work (or major fraction thereof, which is defined as any amount of time over two [2] hours). A rest break need not be authorized for employees whose total daily work time is less than three and one half (3.5) hours.

You will be relieved of all duty during your rest break periods. You are free to come and go as you please and are free to leave the premises. You are expected to return to work promptly at the end of any rest break.

If you work a shift from three and one-half (3.5) to six (6) hours in length you will be entitled to one (1) ten-minute rest break. If you work more than six (6) hours and up to 10 hours, you will be entitled to two (2) ten-minute rest breaks. If you work more than 10 hours and up to 14 hours, you will be entitled to three (3) ten-minute rest breaks.

### Timing of Rest Breaks

You are authorized and permitted to take a rest break in the middle of each four hour work period.

Your rest break will be scheduled by Manager

### Meal Period

All nonexempt employees will be provided an uninterrupted unpaid meal period of at least 30 minutes if you work more than five (5) hours in a workday. You must clock out for your meal period. You will be permitted a reasonable opportunity to take this meal period, and you will be relieved of all duty. During your meal period, you are free to come and go as you please and are free to leave the premises. You are expected to return to work promptly at the end of any meal period.

### Timing of Meal Period

Your meal period will be provided no later than the end of your fifth hour of work. For example, if



you begin work at 8:00 a.m., you must start your meal period by 12:59 p.m. (which is before the end of your fifth hour of work).



Your meal period will be scheduled by Manager

#### **Second Meal Period**

If you work more than 10 hours in a day, you will be provided a second, unpaid meal period of at least 30 minutes. Again, you must clock out for your meal period. You will be permitted a reasonable opportunity to take this meal period, and you will be relieved of all duty. There will be no control over your activities during your meal period. During your meal period, you are free to leave the premises and are free to come and go as you please. You are expected to return to work promptly at the end of any meal period.

#### **Timing of Second Meal Period**

This second meal period will be provided no later than the end of your 10th hour of work.

Your second meal period will be scheduled by Manager.

#### **Recording Meal Periods**

You must clock out for any meal period and record the start and end of the meal period.

Employees are not allowed to work "off the clock." All work time must be accurately reported on your time record.

If for any reason you are not provided a meal period in accordance with our policy, or if you are in any way discouraged or impeded from taking your meal period or from taking the full amount of time allotted to you, please immediately notify Manager.

Anytime you miss a meal period that was provided to you (or you work any portion of a provided meal period), you will be required to report to Manager and document the reason for the missed meal period or time worked.

Please also refer to the Organic Care Timekeeping Policy.



## Overtime for Nonexempt Employees

Employees may be required to work overtime as necessary. Only actual hours worked in a given workday or workweek can apply in calculating overtime. Organic Care will attempt to distribute overtime evenly and accommodate individual schedules. All overtime work must be previously authorized by a supervisor. Organic Care provides compensation for all overtime hours worked by non-exempt employees in accordance with state and federal law as follows:

- All hours worked in excess of eight hours in one workday or 40 hours in one workweek will be treated as overtime. A workday begins at 12:01 a.m. and ends at midnight 24 hours later. Workweeks begin each Sunday at 12:01 a.m.;
- Compensation for hours in excess of 40 for the workweek, or in excess of eight and not more than 12 for the workday, and for the first eight hours on the seventh consecutive day of work in one workweek, shall be paid at a rate one and one-half times the employee's regular rate of pay;
- Compensation for hours in excess of 12 in one workday and in excess of eight on the seventh consecutive workday in a workweek shall be paid at double the regular rate of pay; and
- Exempt employees may have to work hours beyond their normal schedules as work demands require. No overtime compensation will be paid to exempt employees.

## Payment of Wages

Paychecks are normally available at the Manager office. If you observe an error on your check, please report it immediately to your supervisor.

All employees of Organic Care are paid every other Friday for work performed during the previous two-week pay period. If a regular payday falls on a holiday, employees will be paid on the workday before the holiday.

Organic Care offers automatic payroll deposit. You may begin and stop automatic payroll deposit at any time. To begin automatic payroll deposit, you must complete a form (available from the payroll department) and return it to payroll at least 10 days before the pay period for which you would like the service to begin. You should carefully monitor your payroll deposit statements for the first two pay periods after the service begins.

To stop automatic payroll deposit, complete the form available from the payroll department and return it to payroll at least 10 days before the pay period for which you would like the service to end. You will receive a regular payroll check on the first pay period after the receipt of the form, provided it is received no later than 10 days before the end of the pay period.



## Recruitment Bonus

Organic Care wants to recruit quality applicants and in order to do so encourages employees to refer qualified candidates to the Company. If your referral is employed by Organic Care, a recruiting bonus of \$500 will be paid to employees under the following terms and schedule:

- Referrals will be paid only if the original employment application completed by the applicant contains the employee's name as the referral source.
- After the applicant has been hired and completed one month of service, the referring employee will be paid \$100.
- After the referral has completed six months of service, the referring employee will be paid \$200.
- After the referral has completed one year of service, the referring employee will be paid \$200.
- If the applicant is referred by more than one employee, the referral bonus will be split equally among the referring employees and paid on the same terms as above.

## Timekeeping Requirements

All nonexempt employees are required to use a software to record time worked for payroll purposes. All time worked must be accurately reported on your time record.

Employees must record their own time at the start and at the end of each work period. Employees must clock out for their meal period and record the start and end of the meal period.

Employees are not allowed to work "off the clock." Working off the clock violates company policy. Any work performed before or after a regularly scheduled shift must be approved in advance by your supervisor. If you perform any off-the-clock work, please report the work to your supervisor.

Employees also must record their time whenever they leave the building for any reason other than Organic Care business.

Employees will be required to certify that their time record is accurate.

Any handwritten marks or changes on the timecard must be initialed by a supervisor. Punching another employee's timecard, allowing another employee to punch your timecard, or altering a timecard is not permissible and is subject to disciplinary action.

Any errors on your timecard should be reported immediately to your supervisor.

Please also refer to Organic Care's Meal and Rest Break Policy.





## **Safety and Health**



## Employees Who Are Required to Drive

Employees whose job duties require them to drive a Company vehicle or their own vehicles for Company business will be required to show proof of current valid driving licenses and proof of insurability under the Company's policy or current effective insurance coverage before the first day of employment.

Organic Care participates in a system that regularly checks state Department of Motor Vehicles (DMV) records of all employees who are required to drive as part of their job.

If an employee is required to drive as part of his or her job, Organic Care retains the right to transfer to an alternative position, suspend, or terminate an employee whose license is suspended or revoked, or who fails to maintain personal automobile insurance coverage or who is uninsurable under the Company's policy.

Employees who drive their own vehicles on Company business will be reimbursed at the current IRS rate per mile.

## Ergonomics

Organic Care is subject to Cal/OSHA ergonomics standards for minimizing workplace repetitive motion injuries. The Company will make necessary adjustments to reduce exposure to ergonomic hazards through modifications to equipment and processes and employee training. The Company encourages safe and proper work procedures and requires all employees to follow safety instructions and guidelines.

Organic Care believes that reduction of ergonomic risk is instrumental in maintaining an environment of personal safety and well-being, and is essential to our business. We intend to provide appropriate resources to create a risk-free environment. If you have any questions about ergonomics, please contact \_\_\_\_\_.

## Fragrance Policy

We strive to maintain a fragrance-free workplace. Employees may not wear any of the following in the workplace or when on the job, regardless of location, if they may come in contact with customers or coworkers: cologne, after shave lotion, perfume, perfumed hand lotion, fragranced hair products, fragranced deodorants and/or similar products.

## Health and Safety

All employees are responsible for their own safety, as well as that of others in the workplace. To help us maintain a safe workplace, everyone must be safety-conscious at all times. Report all work-related injuries or illnesses immediately to your supervisor or to the human resources department. In compliance with California law, and to promote the concept of a safe workplace, Organic Care maintains an Injury and Illness Prevention Program. The Injury and Illness Prevention Program is available for review by employees and/or employee representatives in the general manager's office.



In compliance with Proposition 65, Organic Care will inform employees of any known exposure to a chemical known to cause cancer or reproductive toxicity.



## Recreational Activities and Programs

Organic Care or its insurer will not be liable for payment of workers' compensation benefits for any injury that arises out of an employee's voluntary participation in any off-duty recreational, social, or athletic activity that is not part of the employee's work-related duties.

## Security

Organic Care has developed guidelines to help maintain a secure workplace. Be aware of persons loitering for no apparent reason in parking areas, walkways, entrances and exits, and service areas. Report any suspicious persons or activities to security personnel. Secure your desk or office at the end of the day. When called away from your work area for an extended length of time, do not leave valuable and/or personal articles in or around your workstation that may be accessible. The security of facilities as well as the welfare of our employees depends upon the alertness and sensitivity of every individual to potential security risks. You should immediately notify your supervisor when unknown persons are acting in a suspicious manner in or around the facilities, or when keys, security passes, or identification badges are missing.

## Workplace Violence

Organic Care has adopted the following workplace violence policy to ensure a safe working environment for all employees.

The Company has zero tolerance for acts of violence and threats of violence. Without exception, acts and threats of violence are not permitted. All such acts and threats, even those made in apparent jest, will be taken seriously, and will lead to discipline up to and including termination.

Possession of non-work related weapons on Company premises and at Company-sponsored events shall constitute a threat of violence.

It is every employee's responsibility to assist in establishing and maintaining a violence-free work environment. Therefore, each employee is expected and encouraged to report any incident which may be threatening to you or your co-workers or any event which you reasonably believe is threatening or violent.

You may report an incident to any supervisor or manager.

A threat includes, but is not limited to, any indication of intent to harm a person or damage Company property. Threats may be direct or indirect, and they may be communicated verbally or nonverbally. The following are examples of threats and acts that shall be considered violent - this list is in no way all-inclusive:

Example	Type of Threat
Saying, "Do you want to see your next birthday?"	Indirect
Writing, "Employees who kill their supervisors have the right idea."	Indirect
Saying, "I'm going to punch your lights out."	Direct
Making a hitting motion or obscene gesture	Nonverbal



Displaying weapons	Extreme
--------------------	---------



Stalking or otherwise forcing undue attention on someone, whether romantic or hostile	Extreme
Taking actions likely to cause bodily harm or property damage	Acts of violence

The Company's workplace violence program is described in detail in the Company's Illness and Injury Prevention Program (IIPP).





## Termination



## Employee References

All requests for references must be directed to \_\_\_\_\_ . No other manager, supervisor, or employee is authorized to release references for current or former employees.

By policy, Organic Care discloses only the dates of employment and the title of the last position held of former employees. If you authorize the disclosure in writing, Organic Care also will inform prospective employers of the amount of salary or wage you last earned.

## Involuntary Termination and Progressive Discipline

Violation of Organic Care policies and rules may warrant disciplinary action. The Company has a system of progressive discipline that may include verbal warnings, written warnings, and suspension. The system is not formal, and Organic Care may, in its sole discretion, utilize whatever form of discipline is deemed appropriate under the circumstances, up to, and including, immediate termination of employment. The Company's policy of progressive discipline in no way limits or alters the at-will employment relationship.

## Reductions in Force

Under some circumstances, Organic Care may need to restructure or reduce its workforce. If restructuring our operations or reducing the number of employees becomes necessary, the Company will attempt to provide advance notice, if possible, to help prepare affected individuals. If possible, employees subject to layoff will be informed of the nature of the layoff and the foreseeable duration of the layoff, whether short-term or indefinite.

In determining which employees will be subject to layoff, Organic Care will take into account, among other things, operation and requirements, the skill, productivity, ability, and past performance of those involved, and also, when feasible, the employee's length of service.

## Voluntary Resignation

Voluntary resignation results when an employee voluntarily quits his or her employment at Organic Care, or fails to report to work for three consecutively scheduled workdays without notice to, or approval by, his or her supervisor (unless the absence is protected by law). All Company-owned property, including vehicles, keys, uniforms, identification badges, and credit cards, must be returned immediately upon termination of employment.



## **Confirmation of Receipt**



## Confirmation of Receipt

I have received my copy of the Company's employee handbook. I understand and agree that it is my responsibility to read and familiarize myself with the policies and procedures contained in the handbook.

I understand and agree that nothing in the employee handbook creates or is intended to create a promise or representation of continued employment and that employment at Organic Care is employment at-will; employment may be terminated at the will of either the Company or myself. My signature certifies that I understand that the foregoing agreement on at-will status is the sole and entire agreement between Organic Care and myself concerning the duration of my employment and the circumstances under which my employment may be terminated. It supersedes all prior agreements, understandings, and representations concerning my employment with Organic Care.

I understand that except for employment at-will status, any and all policies or practices can be changed at any time by the Company. Organic Care reserves the right to change my hours, wages, and working conditions at any time. I understand and agree that other than the president of Organic Care, no manager, supervisor, or representative of the Company has authority to enter into any agreement, express or implied, for employment for any specific period of time, or to make any agreement for employment other than at-will; only the owner(s) or president has the authority to make any such agreement and then only in writing, signed by the owner(s) or president.

Employee's Signature \_\_\_\_\_

Employee's Printed Name \_\_\_\_\_

Date \_\_\_\_\_

23

Property Photo Plate



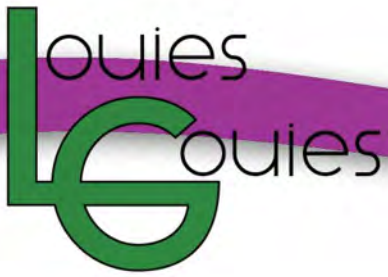

**Exterior Building Photographs for  
316 Yolanda Avenue, Santa Rosa, CA 95404**



## Aerial View of 316 Yolanda Avenue







A. East Front Facade To Be Improved with ADA Ramp and Landscaping



B. West Front Facade To Be Improved





C. Side (East) Facade with Driveway & Access Doors. Will be cleaned and maintained for visitors.



D. Rear Yard Sheds to Be Removed



E. View of Rear Yard Sheds



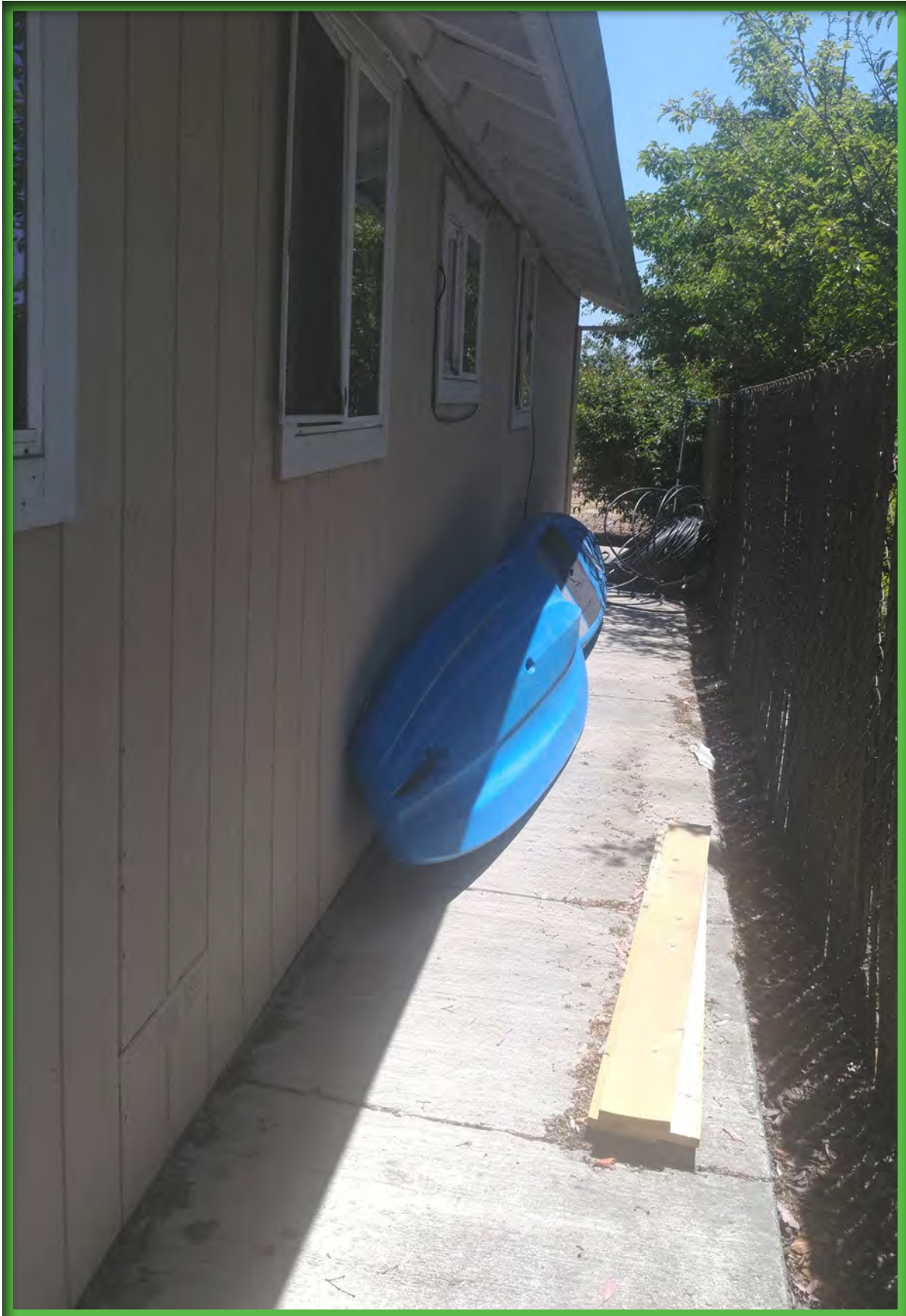

F. West Side Yard of Property With Existing Sidewalk for ADA Accessibility



**G. Front Entry to Be Improved with an Attractive Ramp, Railing, Parking Area, and Landscaping.**



**H. Newly Installed Dual Pane Windows in Good Condition with Minimal Maintenance Issues (Permit for Inserts Not Required)**





I. Dilapidated Rear Gate and Fence to be Removed



J. Rear Property Fence to be Replaced with Landscaped Parking Area





K. Rear Property Gate and Fence to be Replaced with Landscaping and Parking Area.

**23**

**Neighborhood Photo Plate**



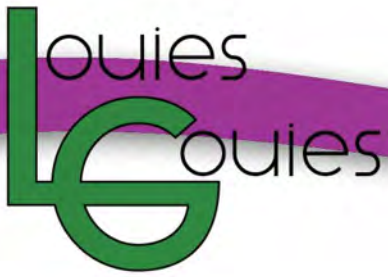

**Exterior Building Photographs for  
316 Yolanda Avenue, Santa Rosa, CA 95404**



## Aerial View of 316 Yolanda Avenue With Surrounding Properties and Businesses





A. Adjacent East Property



B. Adjacent East and South Property





C. Adjacent South Property



C. Adjacent Northwest Property





D. Adjacent North Property



E. Adjacent North Property



F. Adjacent Northeast Property



G. Adjacent West Property - Kenpo 5.0 Martial Arts





G. Left side of adjacent property - Subway.



G. Front of neighboring property - Starbucks



G. Neighboring property to the left - Malm Fireplace Central



G. Neighboring property on Santa Rosa - Batteries & Bulbs





G. Neighboring property on Santa Rosa - Metro PCS



G. Neighboring property - West Coast Auto Gallery



G. Neighboring property - 7 Eleven



G. Neighboring property directly across the street





G. Neighboring property - Magic Motors



G. Neighboring property - McDonald's on Santa Rosa Ave

# Materials Board



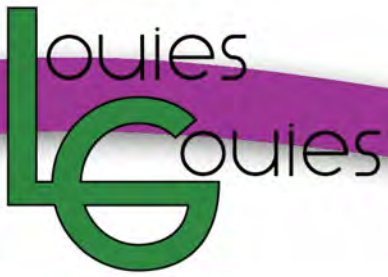

## **Materials Board**

**316 Yolanda Avenue, Santa Rosa, CA 95404**





Security door locking mechanism



Granite retail countertop



Interior security door



Exterior security door



Key card entry for restricted doors





High quality and stylized reception room



Glass retail case used interchangeably with granite countertop





High quality laminate flooring replacement throughout the building































 WEEDMAPS VERIFIED - Verified menu items let you know that you're getting authentic products from your favorite brands.



Indica (7)

Highest Eighth Price ▾

SHOW ALL PRICES









	<b>Edmans Og (Reg) 60</b> INDICA					1/8 <b>40.00</b>	1/4 ---
	<b>Green Crack (Reg) 60</b> INDICA					1/8 <b>29.00</b>	1/4 ---
	<b>Light Dep Sunset Sherbert (Reg) 60</b> INDICA					1/8 <b>20.00</b>	1/4 <b>40.00</b>
	<b>SPECIAL 70 Oz Barry White</b> INDICA					1/8 ---	1/4 ---
	<b>SPECIAL INDICA HIGH ON CEMENT</b> INDICA					1/8 ---	1/4 ---
	<b>Special!! Cookies, Blue Dream</b> INDICA					1/8 ---	1/4 ---
	<b>TMT</b> INDICA					1/8 <b>40.00</b>	1/4 <b>100.00</b>



# Sativa (8)

Highest Eighth Price ▾











[SHOW ALL PRICES](#)











	<b>\$2 grams 30 gram min</b> SATIVA	THC ---%	CBG ---%	CBN ---%	TERPENES -----	1/8 <b>25.00</b>	1/4 <b>40.00</b>
	<b>buy one get one</b> SATIVA	THC ---%	CBG ---%	CBN ---%	TERPENES -----	1/8 ---	1/4 ---
	<b>BUY ONE GET ONE Lemon Bu</b> SATIVA	THC ---%	CBG ---%	CBN ---%	TERPENES -----	1/8 ---	1/4 ---
	<b>Cookie Dough 75/14gram</b> SATIVA	THC ---%	CBG ---%	CBN ---%	TERPENES -----	1/8 ---	1/4 <b>50.00</b>
	<b>Fruity cross buy one get one</b> SATIVA	THC ---%	CBG ---%	CBN ---%	TERPENES -----	1/8 ---	1/4 ---
	<b>SPECIAL 75 Indo (14 gram)</b> SATIVA	THC ---%	CBG ---%	CBN ---%	TERPENES -----	1/8 <b>30.00</b>	1/4 <b>60.00</b>
	<b>SPECIAL Sour Diesel</b> SATIVA	THC ---%	CBG ---%	CBN ---%	TERPENES -----	1/8 ---	1/4 ---
	<b>Super Sour Diesel</b> SATIVA	THC ---%	CBG ---%	CBN ---%	TERPENES -----	1/8 ---	1/4 ---

# Hybrid (24)

Highest Eighth Price ▾

[SHOW ALL PRICES](#)

	<p><b>Guava</b> </p> <p>HYBRID   CONNECTED CANNABIS CO.</p>	THC --- %	CBD --- %	CBG --- %	TERPENES -----	1/8 <b>50.00</b>	1/4 ---
	<p><b>Mochi</b> </p> <p>HYBRID   CONNECTED CANNABIS CO.</p>	THC --- %	CBD --- %	CBG --- %	TERPENES -----	1/8 <b>60.00</b>	1/4 <b>110.00</b>
	<p><b>#FIRESALE DosiDo</b></p> <p>HYBRID</p>	THC --- %	CBD --- %	CBG --- %	TERPENES -----	1/8 <b>40.00</b>	1/4 <b>70.00</b>
	<p><b>#RARE GMO GELATO CAKE</b></p> <p>HYBRID</p>	THC --- %	CBD --- %	CBG --- %	TERPENES -----	1/8 <b>70.00</b>	1/4 <b>140.00</b>
	<p><b>1\$ gram 60 gram min</b></p> <p>HYBRID</p>	THC --- %	CBD --- %	CBG --- %	TERPENES -----	1/8 <b>22.00</b>	1/4 <b>40.00</b>
	<p><b>14grm 75.00 Orange Cookies</b></p> <p>HYBRID</p>	THC --- %	CBD --- %	CBG --- %	TERPENES -----	1/8 <b>30.00</b>	1/4 ---
	<p><b>30% THC Cookies n Cream</b> (re</p> <p>HYBRID</p>	THC --- %	CBD --- %	CBG --- %	TERPENES -----	1/8 <b>45.00</b>	1/4 <b>80.00</b>
	<p><b>420 Special!!! Sun Grown: Che</b></p> <p>HYBRID</p>	THC --- %	CBD --- %	CBG --- %	TERPENES -----	1/8 ---	1/4 ---

	<b>Girl Scout Cookies</b> HYBRID	THC --- %	CBD --- %	CBN --- %	TERPENES -----	1/8 <b>25.00</b>	1/4 <b>45.00</b>
	<b>Girl Scout Cookies indoor (Reg)</b> HYBRID	THC --- %	CBD --- %	CBN --- %	TERPENES -----	1/8 <b>45.00</b>	1/4 ---
	<b>Golden Goat (Reg) 65</b> HYBRID	THC --- %	CBD --- %	CBN --- %	TERPENES -----	1/8 <b>55.00</b>	1/4 ---
	<b>Gorilla Glue (Reg) 60</b> HYBRID	THC --- %	CBD --- %	CBN --- %	TERPENES -----	1/8 <b>50.00</b>	1/4 ---
	<b>Gushers</b> HYBRID	THC --- %	CBD --- %	CBN --- %	TERPENES -----	1/8 <b>65.00</b>	1/4 ---
	<b>Indo Sunset Sherbs (Reg) 60</b> HYBRID	THC --- %	CBD --- %	CBN --- %	TERPENES -----	1/8 <b>40.00</b>	1/4 ---
	<b>Lem Og (Reg 65) 23.96% THC</b> HYBRID	THC --- %	CBD --- %	CBN --- %	TERPENES -----	1/8 <b>45.00</b>	1/4 <b>80.00</b>
	<b>Mimosa # 6 (Reg) 60</b> HYBRID	THC --- %	CBD --- %	CBN --- %	TERPENES -----	1/8 <b>50.00</b>	1/4 ---
	<b>Peanut Butter Breath</b> HYBRID	THC --- %	CBD --- %	CBN --- %	TERPENES -----	1/8 <b>55.00</b>	1/4 ---
	<b>Purple Punch (reg) 65</b> HYBRID	THC --- %	CBD --- %	CBN --- %	TERPENES -----	1/8 <b>45.00</b>	1/4 <b>95.00</b>





### Runtz (reg) 65

HYBRID

THC

---%

CBH

---%

CBN

---%

TERPENES

-----

1/8

**60.00**

1/4

**110.00**



### SALE Connected Products

HYBRID

THC

---%

CBH

---%

CBN

---%

TERPENES

-----

1/8

---

1/4

**110.00**



### Sale Connected Products

HYBRID

THC

---%

CBH

---%

CBN

---%

TERPENES

-----

1/8

---

1/4

**110.00**

# Extract (34)

Highest Half Gram Price ▾

[SHOW ALL PRICES](#)

	<p><b>.7 Cartidges (reg) 65</b> CONCENTRATE</p>	<p>THC ---%</p> <p>CBD ---%</p> <p>CBN ---%</p> <p>TERPENES -----</p>	.5G	1G <b>50.00</b>
	<p><b>3 for 90</b> CONCENTRATE</p>	<p>THC ---%</p> <p>CBD ---%</p> <p>CBN ---%</p> <p>TERPENES -----</p>	.5G	1G ---
	<p><b>Baller Buckets (Reg) 450 Today</b> CONCENTRATE</p>	<p>THC ---%</p> <p>CBD ---%</p> <p>CBN ---%</p> <p>TERPENES -----</p>	.5G	1G <b>60.00</b>
	<p><b>Beezle Extracts (Reg Price \$30)</b> CONCENTRATE</p>	<p>THC ---%</p> <p>CBD ---%</p> <p>CBN ---%</p> <p>TERPENES -----</p>	.5G	1G ---
	<p><b>Beezle Lemon Tree Black Label</b> CONCENTRATE</p>	<p>THC ---%</p> <p>CBD ---%</p> <p>CBN ---%</p> <p>TERPENES -----</p>	.5G	1G <b>90.00</b>
	<p><b>Critical Zkittlez (Reg Price \$55)</b> CONCENTRATE</p>	<p>THC ---%</p> <p>CBD ---%</p> <p>CBN ---%</p> <p>TERPENES -----</p>	.5G	1G <b>80.00</b>
	<p><b>Eel River Dirty Zprite (Reg Price \$85)</b> CONCENTRATE</p>	<p>THC ---%</p> <p>CBD ---%</p> <p>CBN ---%</p> <p>TERPENES -----</p>	.5G	1G <b>85.00</b>
	<p><b>First Class Concentrate (Reg Price \$40)</b> CONCENTRATE</p>	<p>THC ---%</p> <p>CBD ---%</p> <p>CBN ---%</p> <p>TERPENES -----</p>	.5G	1G ---
	<p><b>First Class Concentrate (Reg Price \$40)</b> CONCENTRATE</p>	<p>THC ---%</p> <p>CBD ---%</p> <p>CBN ---%</p> <p>TERPENES -----</p>	.5G	1G ---



### First Class Concentrates (Reg

CONCENTRATE

THC ---% CBD ---% CBN ---% TERPENES -----

.5G 1G  
**40.00 80.00**



### Gold Magic 'Muffins'

CONCENTRATE

THC ---% CBD ---% CBN ---% TERPENES -----

.5G 1G  
**29.00 ---**



### Gold Magic (reg) 40

CONCENTRATE

THC ---% CBD ---% CBN ---% TERPENES -----

.5G 1G  
**29.00 ---**



### Gold Magic Blue Skittles

CONCENTRATE

THC ---% CBD ---% CBN ---% TERPENES -----

.5G 1G  
**29.00 ---**



### Gold Magic Grape Pie

CONCENTRATE

THC ---% CBD ---% CBN ---% TERPENES -----

.5G 1G  
**29.00 ---**



### Gold Magic Purple Punch

CONCENTRATE

THC ---% CBD ---% CBN ---% TERPENES -----

.5G 1G  
**29.00 ---**



### Gold Magic Purple Punch Live

CONCENTRATE

THC ---% CBD ---% CBN ---% TERPENES -----

.5G 1G  
**29.00 ---**



### Grand Daddy Purple (Reg) 120

CONCENTRATE

THC ---% CBD ---% CBN ---% TERPENES -----

.5G 1G  
**38.00 50.00**



### HINDU ZKITTLEZ 3rd Generation

CONCENTRATE

THC ---% CBD ---% CBN ---% TERPENES -----

.5G 1G  
**--- 90.00**











### Humboldt Terp Council (Reg P)

CONCENTRATE

THC ---% CBD ---% CBN ---% TERPENES -----

.5G 1G  
**--- 130.00**



	<b>Humboldt's Finest Citrus Og (I)</b> CONCENTRATE	THC ---	CBD ---	CBN ---	TERPENES -----	.5G ---	1G <b>90.00</b>
	<b>Illuminati Og Gold Magic</b> CONCENTRATE	THC ---	CBD ---	CBN ---	TERPENES -----	.5G <b>29.00</b>	1G ---
	<b>Irish Cream</b> CONCENTRATE	THC ---	CBD ---	CBN ---	TERPENES -----	.5G ---	1G <b>35.00</b>
	<b>MendoFire (Reg Price \$99.00)</b> CONCENTRATE	THC ---	CBD ---	CBN ---	TERPENES -----	.5G <b>85.00</b>	1G ---
	<b>Noble Headspace (Reg Price \$69.00)</b> CONCENTRATE	THC ---	CBD ---	CBN ---	TERPENES -----	.5G ---	1G <b>69.00</b>
	<b>Noble Headspace (Reg Price \$74.00)</b> CONCENTRATE	THC ---	CBD ---	CBN ---	TERPENES -----	.5G ---	1G <b>74.00</b>
	<b>Noble Headspace (Reg Price \$69.00)</b> CONCENTRATE	THC ---	CBD ---	CBN ---	TERPENES -----	.5G ---	1G <b>69.00</b>
	<b>Orange Tree (Reg Price \$50.00)</b> CONCENTRATE	THC ---	CBD ---	CBN ---	TERPENES -----	.5G <b>45.00</b>	1G ---
	<b>SAUCE 3 GR FOR 90 GREASE</b> CONCENTRATE	THC ---	CBD ---	CBN ---	TERPENES -----	.5G ---	1G <b>40.00</b>



### Shatter

CONCENTRATE

THC

CBD

CBN

TERPENES

5G

1G

22.00



### Shatter

CONCENTRATE

THC

CBD

CBN

TERPENES

5G

1G

18.00



### Terp Preservation Society (Reg)

CONCENTRATE

THC

CBD

CBN

TERPENES

5G

1G

85.00



### Wax Butter (Sale) 45 (Reg)

CONCENTRATE

THC

CBD

CBN

TERPENES

5G

1G

35.00



### Wax Dab

CONCENTRATE

THC

CBD

CBN

TERPENES

5G

1G

25.00



### ZKITTLEZ 3rd Generation Fat

CONCENTRATE

THC

CBD

CBN

TERPENES













5G

1G

90.00

# Edible (10)

Highest Price ▾

	<p><b>BROWNIES - 500MG</b> </p> <p>EDIBLE   LOL EDIBLES</p>	THC	CBD	CBN	TERPENES	EACH
		---	---	---	-----	<b>18.00</b>
	<p><b>G-BAR - 250MG</b> </p> <p>EDIBLE   LOL EDIBLES</p>	THC	CBD	CBN	TERPENES	EACH
		---	---	---	-----	<b>18.00</b>
	<p><b>LOOP FRUITS INFUSED CERE</b> </p> <p>EDIBLE   LOL EDIBLES</p>	THC	CBD	CBN	TERPENES	EACH
		---	---	---	-----	<b>18.00</b>
	<p><b>Chocolate Cupcake</b></p> <p>EDIBLE</p>	THC	CBD	CBN	TERPENES	EACH
		---	---	---	-----	<b>10.00</b>
	<p><b>Gummy's</b></p> <p>EDIBLE</p>	THC	CBD	CBN	TERPENES	EACH
		---	---	---	-----	<b>24.00</b>
	<p><b>LOL Edibles Jolly Rocker</b></p> <p>EDIBLE</p>	THC	CBD	CBN	TERPENES	EACH
		---	---	---	-----	<b>6.00</b>
	<p><b>Straws Super Infused</b></p> <p>EDIBLE</p>	THC	CBD	CBN	TERPENES	EACH
		---	---	---	-----	<b>16.00</b>
	<p><b>Super Infused Cookie</b></p> <p>EDIBLE</p>	THC	CBD	CBN	TERPENES	EACH
		---	---	---	-----	<b>20.00</b>
	<p><b>Super Infused Peanut Butter</b></p> <p>EDIBLE</p>	THC	CBD	CBN	TERPENES	EACH
		---	---	---	-----	<b>15.00</b>
	<p><b>Super Infused Straw 420 spec</b></p> <p>EDIBLE</p>	THC	CBD	CBN	TERPENES	EACH
		---	---	---	-----	<b>15.00</b>



# Preroll (1)

Highest Price ▼



## Pre-roll With Live Resin (reg)

PREROLL

THC

— %

CBG

— %

CBN

— %

TERPENES

EACH

**18.00**



## Section P – Product Brochures



ACEPAY

## ACEpay: The Compliant Solution to Cannabis Banking

### Amercanex: A Comprehensive Ecosystem for Cannabis Regulation

Amercanex Corporation, a subsidiary of GreenTree International, is a financial technology company that has created an innovative, comprehensive regulatory ecosystem that addresses the regulatory and business challenges of the cannabis industry. The technology includes a track and trace solution (ACEtrak, powered by Adilas) that follows cannabis products from the seed all the way to the consumer, an electronic wholesale marketplace for licensed participants (ACE Marketplace), and finally, a mobile payment solution with fiscal management services (ACEpay, powered by Vertepay) that connect cannabis businesses with credit unions and banks in a transparent, federally and state-compliant manner, effectively changing the game for the cannabis industry. For the first time ever, regulatory oversight, control mechanisms, and tax verification and collection measures are within reach for government and regulatory authorities. This fact sheet focuses on the ACEpay solution. If interested in any of our other Amercanex products, please reach out to the contacts below.

#### ACEpay: Digitization of Cannabis Payments

ACEpay operates as a closed-loop membership payment system. It is an e-wallet solution that members can use to send and receive payments that is fully compliant with federal and state fiscal laws. All funds are held 100% traceable, verifiably clean, and held at partner credit unions and banks. The end result is that ACEpay members (i.e. cannabis entrepreneurs, regulatory agencies, ancillary businesses, etc.) are able to freely use the cashless, electronic funds from their account for non-cannabis needs: filling up at the gas pump, grocery shopping, paying mortgages, purchasing healthcare benefits and more.

#### How It Works.

ACEpay operates as a non-bank financial institution. Payments are conducted either using a membership account or through smart-safe technology in cases when cash transactions are allowed. Members can either use the e-wallet technology or a pre-paid card for payments. We perform a full "Know Your Client" audit and screening on every member upon opening an ACEpay account, during fund movements, and on a daily basis to ensure that members are suitable for working with our partner credit unions and banks. Our partner credit unions and banks also perform their own audit and screens to satisfy their requirements. What happens next? Every transaction is reported, keeping all parties accountable. All taxes due are verified and collected. Proprietary algorithms are utilized at all times to search for and detect unusual activity. All

suspicious activity is reported as required to the proper agencies.

#### The ACEpay Difference: No Masking, Just Compliance.

Risk minimization is a cornerstone of the ACEpay solution. Our leadership team has decades of experience working in the financial industry and fully understands federal and state banking regulations and compliance. As such, unlike other solutions, we do not act as an intermediary for funds from cannabis businesses. We ensure that our members' funds are held by our partner credit unions and banks in a transparent manner: banks know who our cannabis clients are and what they do. Furthermore, ACEpay goes above and beyond in terms of compliance with federal and state fiscal laws. Our technology is not only compliant with the 2013 Cole Memo and FinCEN Memo, but it also meets the standards of Dodd-Frank and the Bank Secrecy Act. Our policy and procedures manual contains a robust anti-money laundering program that meets or exceeds U.S. and international standards. If any investigations are conducted, we have the records to show our full compliance with federal and state laws.

#### Where We Are.

The ACEpay solution is fully operational in Colorado with beta pilots currently functioning in California, Pennsylvania, Nevada and Puerto Rico. We are also in discussion with Canadian officials as they prepare to roll out full recreational use of cannabis in July 2018.



ACEXCHANGE

#### Contact Information:

Steve Janjic, CEO | [Steve.Janjic@amercanex.com](mailto:Steve.Janjic@amercanex.com) Michael Herron, COO | [Michael.Herron@amercanex.com](mailto:Michael.Herron@amercanex.com)  
(720) 360-1200

# How Does ACE Work?

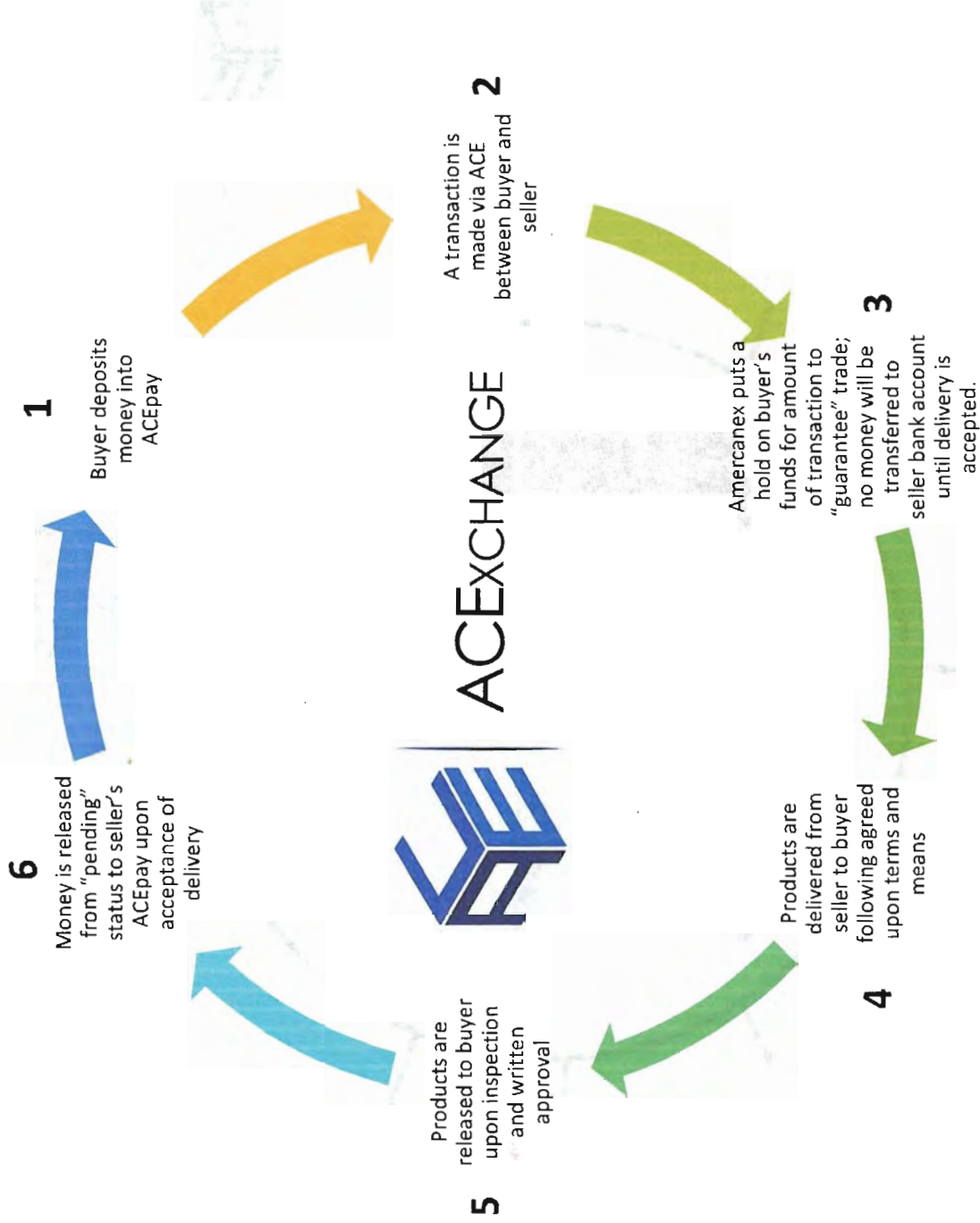



GSS-Doors

TEL

1-406-212-2334

EMAIL

rg@gssdoors.com

WEB

www.gssdoors.com

## FORTRESS SERIES

*Our flagship door, designed for locations at very high risk of attack or forced entry*

The Fortress Series is designed to help create a secure environment for locations with extremely high threat profiles or security challenges. It was tested at NTS Chesapeake in Belcamp, MD to the US State Department (DoS) forced entry standard SD-STD.01.01 Rev. G at the 15 minute level (FE 15). It was also tested at the iFT Rosenheim laboratory in Germany and was awarded a resistance class 4 (RC4) rating according to EN1627.

### TECHNICAL SPECS

- Door and frame constructed from 12 AWG steel
- Armored multi-point locking system with up to 20 locking points  $\frac{3}{4}$ "  $\varnothing$
- Locks encased in drill resistant manganese
- Door thickness: 3.5" (91mm)
- Frame thickness: 4.5" (115mm)
- Handgun or rifle level ballistic resistance - **optional**
- 90 minute UL fire rating - **optional**
- Welded, adjustable ball bearing security hinges
- $\frac{1}{2}$ " (12mm) or  $\frac{3}{4}$ " (18mm) thick decorative panels
- 2" of rock wool for sound and thermal insulation
- Door is pre-hung to the frame
- L-shaped frame profile
- Frame is secured in the wall using 16 bolts protected by 1" steel shims.
- Unlimited design and glass options

12 Active locking bolts



8 Hinge side inactive bolts

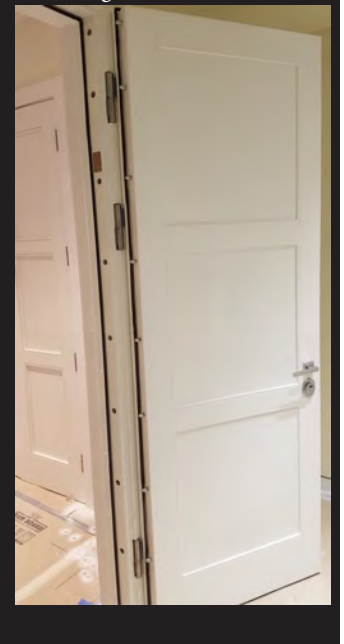

### HARDWARE

- High security bump and pick resistant Mul-T-Lock cylinders
- Drill resistant cylinder defenders
- Available lock options: Mottura 85 series (mechanical) or Fiam X1R (motorized)
- Lockout function - optional with mechanical lock only

### DIMENSIONS

- Height: up to 110" (depending on decorative panels)
- Width: up to 49"
- Inswing or outswing

### FB4 BALLISTIC (EQV.UL752 - LEVEL 3)

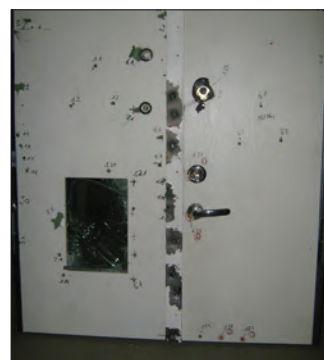

ATTACK SIDE



SECURE SIDE





GSS-Doors  
TEL 1-406-212-2334  
EMAIL rg@gssdoors.com  
WEB www.gssdoors.com

## State Department Forced Entry 15 Testing

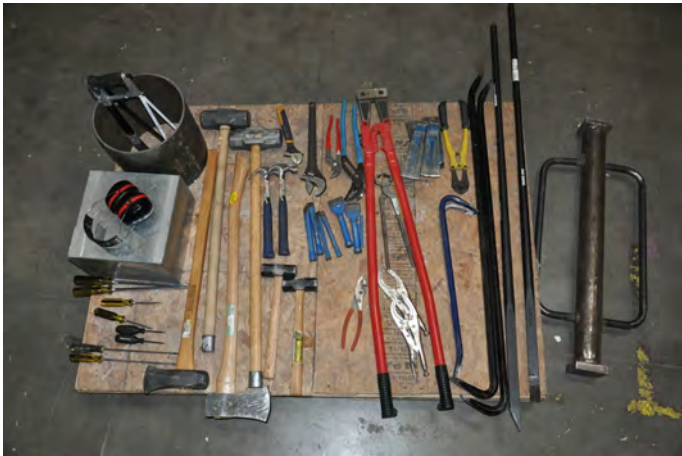

## State Department Bullet Resistant Tested Up To Level 8







GSS-Doors

TEL

1-406-212-2334

EMAIL

rg@gssdoors.com

WEB

www.gssdoors.com

## CROSS SECTIONS

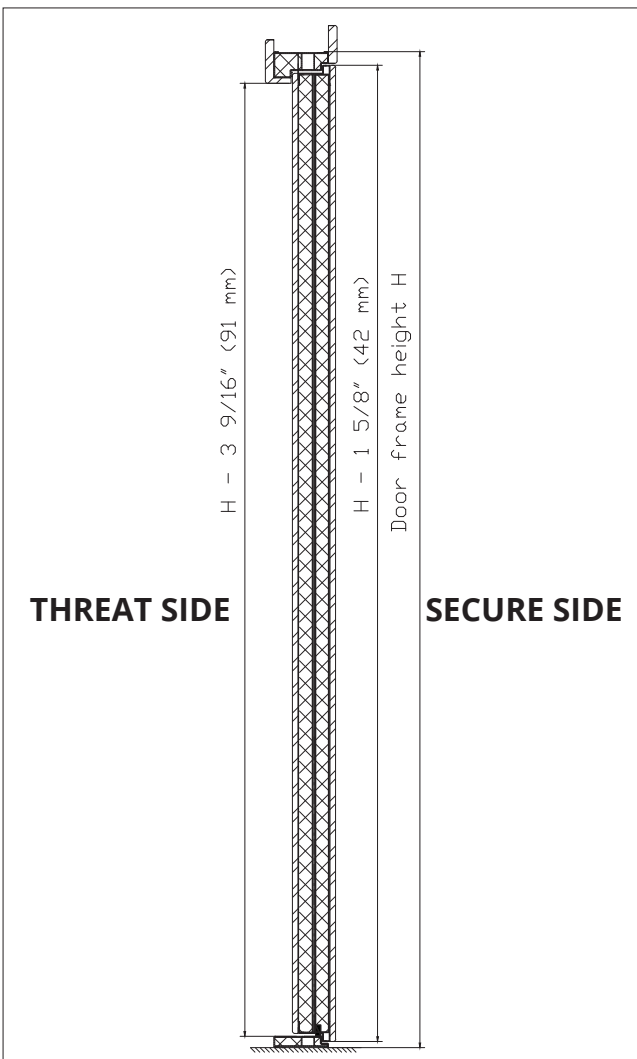
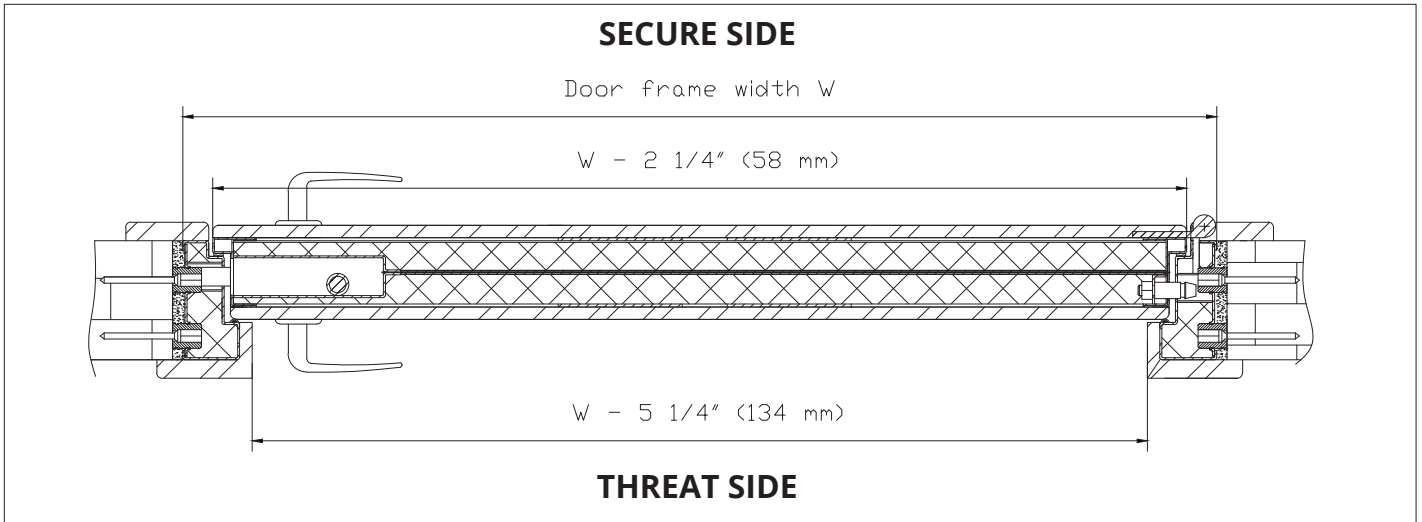

## INSTALLATION FAQ

- The Fortress series comes as a pre-hung door set and includes frame, locks, cylinders, handles, hinges, and hardware.
- It can be installed by any licensed GC or door installer.
- No specialized training or tools required!
- A 1/2" to 3/4" gap is required on all sides between the frame and wall (rough opening).
- The Fortress series frame is designed to adapt to crooked walls and openings.
- For detailed instructions, **download** our installation manual.

## CRL Stock Standard Inset Frame Exchange Window

- With Bullet Resistant Speak-Thru and Shelf With Deal Tray
- Fits Walls at Least 4-7/8" (124 mm) Thick
- Assembled and Ready to Install

This Standard Inset Frame Exchange Window is designed for walls with a thickness of at least 4-7/8" (124 mm). The unit slides into the opening and is secured by installing screws through the perimeter frame and into the sides of the opening. Window is supplied with a 12" (305 mm) deep Stainless Steel Shelf with built-in Non-Ricochet Bullet Resistant Deal Tray. Glazing is 1-1/4" (32 mm) thick bullet resistant acrylic with a Level 1 protection rating. The Cat. No. N666 Level 3 rated Stainless Steel Speak-Thru allows natural voice transmission (see page GG167). An overhang or awning is recommended if used in an exterior application. Two finishes and two sizes are available in stock. Custom units are available go to [crlaurence.com/bullet-resistant](http://crlaurence.com/bullet-resistant).

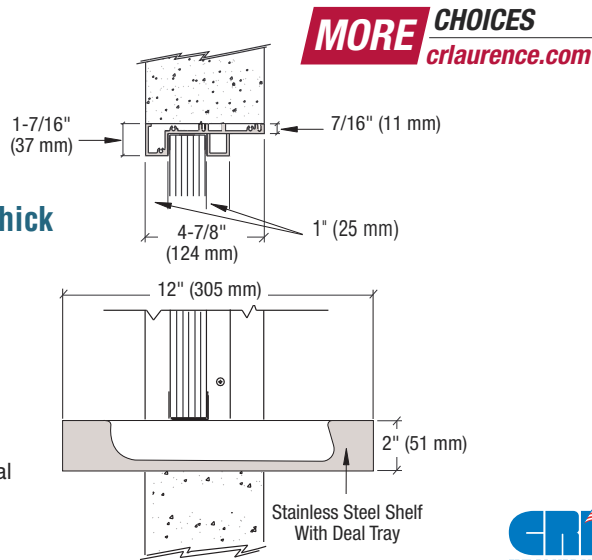

**MORE INFORMATION**  
[crlaurence.com](http://crlaurence.com)

### SPECIFICATIONS:

**Materials:** Frame - .125" (3.2 mm) Thick Extruded 6063-T5 Aluminum Alloy; Glazing - 1-1/4" (32 mm) Level 1 Acrylic; Shelf - Stainless Steel

**Finishes:** Frame - Satin Anodized or Duranodic Bronze; Shelf - Brushed Stainless Steel #4 Finish 16 Gauge

**Speak-Thru:** N666 Level 3 Stainless Steel

**Deal Tray:** Level 1 Protection

**Instructions Included**

CAT. NO.	FINISH	OVERALL SIZE (W X H)	WALL OPENING SIZE (W X H)
S1EW2436A	Satin Anodized	24" x 36" (610 x 914 mm)	24-1/2" x 36-1/4" (622 x 921 mm)
S1EW2436DU	Duranodic Bronze	24" x 36" (610 x 914 mm)	24-1/2" x 36-1/4" (622 x 921 mm)
S1EW3636A	Satin Anodized	36" x 36" (914 x 914 mm)	36-1/2" x 36-1/4" (927 x 921 mm)
S1EW3636DU	Duranodic Bronze	36" x 36" (914 x 914 mm)	36-1/2" x 36-1/4" (927 x 921 mm)

Minimum order: 1 each. F.O.B. All CRL Service Centers.

## CRL Night Service Window

- Glazed With 1-1/4" (32 mm) Bullet Resistant Level 1 Acrylic
- Stainless Steel Shelf With Non-Ricochet Bullet Resistant Tray
- Assembled and Ready to Install

Our Night Service Window is of the kind frequently used for motel registration or 24 hour service station windows. The 16 gauge stainless steel housing is glazed with 1-1/4" (32 mm) bullet resistant acrylic. This is mounted on a 16 gauge stainless steel shelf that measures 14-3/16" (360 mm) wide x 18" (457 mm) deep x 2" (51 mm) thick. The shelf has a Non-Ricochet Bullet Resistant Tray for passing cash, credit cards, keys, etc. The entire unit slides into a wall opening roughly 14-3/4" (375 mm) wide x 20" (508 mm) high. The flange surrounding the wall opening is 2" (51 mm) wide. Custom size units are available to suit your needs. The Standard unit does not have a speak-thru. Voice transmission is via the cash tray. An overhang is recommended for exterior use.

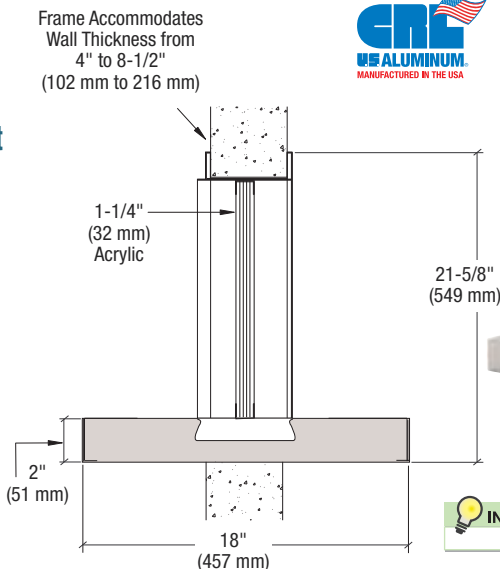

### SPECIFICATIONS:

**Materials:** 16 Gauge Stainless Steel; Clear Acrylic

**Glazing:** 1-1/4" (32 mm) Level 1 Acrylic

**Finish:** Brushed Stainless Steel #4 Finish

**Deal Tray:** Level 1 Protection

**Instructions Included**

CAT. NO.	OVERALL SIZE (W X H)	WALL OPENING SIZE (W X H)
SW101N	18-3/16" x 18" x 21-5/8" (462 x 457 x 549 mm)	14-3/4" x 20" (375 x 508 mm)

Minimum order: 1 each. F.O.B. All CRL Service Centers.

go to [crlaurence.com](http://crlaurence.com) to search for

**bullet-resistant**

Search

or enter the Catalog Number for complete product information

**GG161**

**TOLL Phone:** (800) 421-6144  
**FREE Fax:** (800) 262-3299  
From Anywhere in the U.S. or Canada



🏠 [\\_ \(HTTPS://WWW.GOKEYLESS.COM\)](https://www.gokeyless.com) > [PRODUCTS \(HTTPS://WWW.GOKEYLESS.COM/SHOP/\)](https://www.gokeyless.com/shop/) > [COMMERCIAL \(HTTPS://WWW.GOKEYLESS.COM/SHOP/COMMERCIAL-KEYLESS-LOCKS/\)](https://www.gokeyless.com/shop/commercial-keyless-locks/) > [ELECTRONIC \(HTTPS://WWW.GOKEYLESS.COM/SHOP/COMMERCIAL-KEYLESS-LOCKS/ELECTRONIC-COMMERCIAL-LOCKS/\)](https://www.gokeyless.com/shop/commercial-keyless-locks/electronic-commercial-locks/)



## TRILOGY PDL3000 PROX CARD LOCK WITH AUDIT TRAIL

\$889.61 - \$1,135.31

Finish

Key Override

**ADD TO CART**

(<https://www.gokeyless.com/wp-content/uploads/2015/03/257.jpg>)



(<https://www.gokeyless.com/wp-content/uploads/2015/03/257.jpg>) (<https://www.gokeyless.com/wp-content/uploads/2015/03/257.jpg>) (<https://www.gokeyless.com/wp-content/uploads/2015/03/257.jpg>) (<https://www.gokeyless.com/wp-content/uploads/2015/03/257.jpg>)

**SAFE AND SECURE**  
100% Price & Performance Guarantee

(<https://www.gokeyless.com/30-day-money-back-guarantee/>)

SKU: PDL3000

<a href="#">Features</a>
<a href="#">Description</a>
<a href="#">Specs</a>
<a href="#">Reviews (7)</a>
<a href="#">Customer Q&amp;A (13)</a>
<ul style="list-style-type: none"> <li>• Heavy Duty, Grade 1 electronic dual PIN/Prox cylindrical latch (<a href="https://www.gokeyless.com/images/slb.jpg">https://www.gokeyless.com/images/slb.jpg</a>) lock. Underwriters Laboratory (UL) listed</li> <li>• Compatible with any HID 125KHZ prox cards 26-48bit</li> <li>• Rugged clutch mechanism insures long life &amp; durability</li> <li>• Enrolled users gain access by card only, pin only, or highest security – card plus pin</li> <li>• Program at lock, or via your laptop or desktop using Windows PC based software; requires <a href="https://www.gokeyless.com/product/alarm-lock-al-pci2u-software-kit/">PC interface cables (https://www.gokeyless.com/product/alarm-lock-al-pci2u-software-kit/)</a> in order to transfer your user data to the lock and download and review your audit trail. (software CD included with purchase of cables, or can be downloaded from Alarm Lock website)</li> </ul>

- Desktop PC management requires **DTM-III** (<https://www.gokeyless.com/product/alarm-lock-dtmiii-data-transfer-module/>) to transfer files from your computer to the lock
- **Real-time Clock** lets you scheduled up to 500 timed events, including holiday schedules. Program lock to auto lock at certain times, or auto-unlock. Program times when certain users or groups of users can gain access
- **2000 User Codes/Cards:** Master, manager, supervisor, and basic users
- Program one-time entry codes, quick passage mode, passage mode, emergency and service codes, and lockout codes
- First manager in scheduling – solves the snow day issue for schools (*"First Person In" stops unauthorized persons from gaining access to doors set on timed auto-unlock*)
- Weatherproof performance
- New! **Remote Release Kit** (<https://www.gokeyless.com/product/alarm-lock-rrtrilogykit-remote-release-kit/>) for 'Buzz-In'
- Program allowable entry time from 3-15 seconds – how long user has once they present prox card or pin before door relocks
- Greater security with "Temporary Keypad Lockout" after 3 unsuccessful code-entry attempts
- **Audit Trail;** time/date stamp for a printable record of all electronic activity. Audit trail of key override available in PDL3000K model, custom orders only
- Real-time clock allows logging of events to within 1 second of accuracy
- 4 Time-out functions allow a user to enable other users or unlock the lock for some time period without needing to return to the lock
- Easy to install. Retrofits most **cylindrical** (<https://www.gokeyless.com/images/slb.jpg>) locksets and digital locks
- Choose from multiple **architectural finishes** (<https://www.gokeyless.com/wp-content/uploads/2016/07/trilogyfinishes.gif>)
- Available in standard key override and **interchangeable core** (<https://www.gokeyless.com/IC.htm>) models accepting 6 or 7 pin cores from Arrow, Best, Falcon, or KSP, and removable cores from Schlage, Medeco, Yale, Sargent, Medeco, and Corbin (use your own cores in the lock, or you may order one from us [here](https://www.gokeyless.com/shop/accessories/key-cylinders/) (<https://www.gokeyless.com/shop/accessories/key-cylinders/>)) Best and Schlage IC locks in 26D satin chrome generally ship same day, others may be subject to a lead time
- Backset: 2 3/4" included (2 3/8" available at checkout) [How do I measure?](https://www.gokeyless.com/backset.htm) (<https://www.gokeyless.com/backset.htm>)
- Battery Operation: 5 AA's; appx. 60,000 cycles; low battery alerts
- Red / Black wires – External 7.5 VDC Power Source must be used for operation without batteries
- Audit trail capacity: 40,000 records
- Keypad: All metal, 12 button. All functions programmable through keypad/software. Proximity antenna housing molded of ultra high strength, impact resistant Lexan.
- Warranty: 2 year manufacturer

## AUTHORIZED DEALER

GoKeyless is an authorized dealer for Alarm Lock. It is a highly esteemed role that is not easy to achieve or maintain. It requires great commitment to our customers. This provides many benefits to you including:

- Expert Advice
- Warranty Protection
- Free Basic Training
- Simple Returns



**MONEY BACK  
GUARANTEE**



**FREE GROUND SHIPPING  
ORDERS  
OVER \$97\***



**GREAT CUSTOMER  
SUPPORT**

[SHOP](https://www.gokeyless.com/shop)

([HTTPS://WWW.GOKEYLESS.COM/SHOP](https://www.gokeyless.com/shop))

[MY ACCOUNT](https://www.gokeyless.com/my-account)

([HTTPS://WWW.GOKEYLESS.COM/MY-ACCOUNT](https://www.gokeyless.com/my-account))

[CUSTOMER SERVICE](https://www.gokeyless.com/customer-service)

([HTTPS://WWW.GOKEYLESS.COM/CUSTOMER-SERVICE](https://www.gokeyless.com/customer-service))

[RETURNS](https://www.gokeyless.com/returns)

([HTTPS://WWW.GOKEYLESS.COM/RETURNS](https://www.gokeyless.com/returns))



---

[ABOUT \(HTTPS://WWW.GOKEYLESS.COM/ABOUT/\)](https://www.gokeyless.com/about/), [CONTACT \(HTTPS://WWW.GOKEYLESS.COM/CONTACT/\)](https://www.gokeyless.com/contact/),  
[30 DAY MONEY BACK GUARANTEE \(HTTPS://WWW.GOKEYLESS.COM/30-DAY-MONEY-BACK-GUARANTEE/\)](https://www.gokeyless.com/30-day-money-back-guarantee/),  
[CUSTOMER SERVICE \(HTTPS://WWW.GOKEYLESS.COM/CUSTOMER-SERVICE/\)](https://www.gokeyless.com/customer-service/), [RETURNS \(HTTPS://WWW.GOKEYLESS.COM/RETURNS/\)](https://www.gokeyless.com/returns/),  
[PRIVACY POLICY \(HTTPS://WWW.GOKEYLESS.COM/PRIVACY-POLICY/\)](https://www.gokeyless.com/privacy-policy/), [RAVING FANS \(HTTPS://WWW.GOKEYLESS.COM/RAVING-FANS/\)](https://www.gokeyless.com/raving-fans/),  
[BLOG \(HTTPS://WWW.GOKEYLESS.COM/BLOG/\)](https://www.gokeyless.com/blog/).

© copyright 2018 GoKeyless™



## Q. Labor and Employment

### Q1. Hiring Practices

Louie's Gouie's fully recognizes the value of its human resources, acknowledging that without them, this and our many other business ventures could not have produced their success. This is why the owners and operators of the future Louie's Gouie's dispensary are committed to hiring and employment practices that benefit employees, support their careers and go above and beyond local regulations to ensure the comfort, safety, and enjoyment of our staff, and consequently our customers.

To fill the employment needs of our dispensary operation, Louie's Gouie's intends to acquire employees from the local area and nearby counties before looking elsewhere for expertise not readily available. We will seek those in the area most in need of gainful employment and training, providing an opportunity to learn and contribute to our growth as a company and a community while functioning within the strictest definition of an Equal Opportunity Employer. Candidates will include active military or former military veterans while former felons will not be considered for employment.

We will establish and maintain an Employee register which contains the names, numbers and personal identification information such as, date of birth SSN and Vehicle Operating Licenses for each employee hired by Louie's Gouie's. Employee files will contain criminal background checks, Livescan fingerprinting clearance credentials, Employee Orientation and routine training certifications and any additional information required by State or local regulations and will be kept on file for a minimum of 7 years.

The table below is a summary list of positions for which we will be hiring with additional positions to be added as needed. Each new recruit will be required to pass a criminal background check, which may include cannabis specific clearances from the state or local level over time. In addition, we will require reference checks and standard OSHA compliant drug and alcohol testing.

<b>JOB TITLE</b>	<b>JOB DUTIES SUMMARY</b>
<b>Budtender</b>	Inside sales representative who sells marijuana and marijuana products to customers and etc.
<b>Delivery Driver</b>	Delivers to customers and may transport product or money between growing and retail facilities and etc.
<b>Sales Representative</b>	Sales representative who sells marijuana and marijuana products to customers and etc.
<b>Facilities Maintenance (Non-Contracted)</b>	Facilities maintenance, equipment maintenance, HVAC and etc.
<b>Security</b>	Responsible for facility security monitoring, may accompany sales or delivery employees during sale or delivery services and etc.
<b>Administrative/Dispatch</b>	Responsible for day-to-day operations of the business. May include marketing roles, financial roles, HR roles, retail store management, driver dispatch, etc.

All available Job opportunities will be posted on local job boards, EDD (Employment Development Division), social media, and online to provide a broad range of access for interested applicants. We are well aware of the intense curiosity about the industry and its many employment opportunities like Budtending. To assist in





developing positive interest in these positions, we plan to host special educational events prior to opening as part of a recruiting process and continue as the business grows.

### Q2. Wage Scale

Louie's Gouie's agrees to pay all persons employed by the company to perform services not less than the local minimum wage or Living Wage, as set annually by the Living Wage for Sonoma County. "Living Wage" means 150% of the minimum wage mandated by California or Federal law, whichever is greater.

Role	Anticipated Wage Scale
GM	\$85,000 per year, plus shareholder dividends
Senior Managers	\$75,000 per year plus bonuses
Budtenders/Cashiers/Dispatch/Drivers	\$35,000 plus bonuses
Inventory Control	\$27,000 per year for full time
Security	\$35,000 plus bonuses

### Q3. Employee Training and Development

Louie's Gouie's believes in ongoing employee training and development that enhances the productive capacity of workers, expands the company's knowledge base and fosters employee loyalty. With these principles in mind, Louie's Gouie's intends to make every effort to offer the employees the ability to participate in training programs on and offsite, such programs will be inclusive of, but not limited to:

- **On-site programs:** These include internal training by management, external consultants hired to provide workshops, computer-based training and peer-to-peer training. Some examples of internal training courses to be offered are as follows:
  - Safety in the Workplace
  - Ergonomics
  - Violence Prevention
  - Fire Safety
  - SDS (Safety Data Sheets)
  - Hazard Communication
  - Personal Protection Equipment
- **Off-site programs:** These include seminars, conferences, certificate programs, and online computer courses.
  - Customer Service
  - What to do in the Event of a Robbery
  - Budtending
  - Working with Cannabis Plants
  - Harassment Prevention
  - Preventative training on recurring workplace issues

### Q4. Benefits to be offered:

All full-time employees will be eligible for participation in our company health care policy. Louie's Gouie's will contribute at least \$100 per month per employee toward the cost of health insurance. Full time



employees will be eligible for paid time and all other state mandated leaves of absence off after working one year at the company.

Employees who participate in the company training incentives will receive reimbursement for advanced coursework in industry-related subjects, seminars, conferences and other approved training as determined by our HR manager and the Owners.