



May 1, 2020

Mr. Patrick O'Neill
McBride Lane Apartments LLC
19 Leona Drive
San Rafael, CA 94903

Traffic Study for the 1650 West Steele Lane Project

Dear Mr. O'Neill;

As requested, W-Trans has prepared a focused traffic study for the proposed residential development at 1650 West Steele Lane in the City of Santa Rosa. The purpose of this letter is to address the potential traffic impacts associated with the proposed multifamily residential development.

Project Description

The proposed project would include construction of a three-story 36-unit housing apartment complex including four affordable units on a vacant lot at 1650 West Steele Lane in the City of Santa Rosa. The site would be accessible via a proposed driveway to be constructed on the southern end of the project site off Meadowbrook Court. There would be 36 vehicle parking spaces provided on-site.

Circulation Setting

Vehicular Circulation

The study area consists of West Steele Lane and Meadowbrook Court, which run along the frontages of the project site.

West Steele Lane is generally oriented east-west and is classified as a major collector. Along the project frontage the road has one 12-foot travel lane and a bicycle lane in each direction; the posted speed limit is 35 mph.

Meadowbrook Court is a cul-de-sac in a north-south orientation classified as a residential street. The two-lane street has a posted speed limit of 25 mph.

Pedestrian Facilities

Pedestrian facilities include sidewalks, crosswalks, pedestrian signal phases, curb ramps, curb extensions, and various streetscape amenities such as lighting, benches, etc. Continuous sidewalks are present along the project frontage on West Steele Lane, connected to a curb ramp at the project corner with Meadowbrook Court. There are no sidewalks along the project frontage on Meadowbrook Court to connect to existing sidewalks on West Steele Lane and on Meadowbrook Court south of the project site nor are there sidewalks on the west side of Meadowbrook Court opposite the project site. There is no street lighting on Meadowbrook Court near the project site.

Bicycle Facilities

There are bicycle lanes on West Steele Lane between Marlow Road and Range Avenue, as well as on Range Avenue between Russell Avenue and West Steele Lane. According to the *City of Santa Rosa Bicycle and Pedestrian Master Plan 2018 Update, 2019*, the existing SMART trail is proposed to be extended north between Guerneville Road and north of the City limits. Additionally, existing bicycle lanes on Range Avenue would be extended south to Jennings Avenue. Sharrows are proposed along Hardies Lane between West Steele Lane and Russell Avenue.

Transit Facilities

The closest bus stop from the project is approximately 200 feet to the near Range Avenue. The project site is within the quarter-mile walking distance considered an acceptable walking distance to transit of Santa Rosa CityBus Routes 1, 6 and 10, Mendocino Transit Authority (MTA) Route 95, and Sonoma County Transit (SCT) Routes 20, 30, 44, 48, 54, and 57. These routes provide connectivity from the site throughout the City of Santa Rosa, within the County of Sonoma, and to adjacent Mendocino County. The project site is within one-half mile of both the Santa Rosa North SMART Station and the Copeland Transit Mall. SMART provides access between North Santa Rosa and Larkspur Landing where a connection can be made by ferry to San Francisco. According to the *City of Santa Rosa Bicycle and Pedestrian Master Plan 2018 Update*, existing bicycle lanes on Range Avenue are proposed to be extended south, which would connect the project site between existing bicycle lanes on West Steele Lane and Guerneville Road to the Copeland Mall and the Santa Rosa North SMART Station.

Two bicycles can be carried on most CityBus, SCT, and MTA buses. Bike rack space is a first come first served basis. Additional bicycles are allowed on these buses as the discretion of the driver.

Dial-a-ride, also known as paratransit, or door-to-door service, is available for those who are unable to independently use the transit system due to a physical or mental disability. This service is available through CityBus and SCT. The service is designed to serve the needs of individuals with disabilities within Santa Rosa area and includes area within a three-quarters of a mile from an active CityBus or SCT route.

Trip Generation

The anticipated trip generation for the proposed project was estimated using standard rates published by the Institute of Transportation Engineers (ITE) in *Trip Generation Manual*, 10th Edition, 2017 for a Multifamily Housing (Low-Rise) (Land Use #220). Based on application of these rates, the proposed project is expected to generate an average of 264 trips per day, including 17 a.m. peak hour trips and 20 trips during the p.m. peak hour. These results are summarized in Table 1.

Table 1 – Proposed Trip Generation Summary

Land Use	Units	Daily		AM Peak Hour				PM Peak Hour			
		Rate	Trips	Rate	Trips	In	Out	Rate	Trips	In	Out
Apartments	36 du	7.32	264	0.46	17	4	13	0.56	20	13	7

Note: du = dwelling unit

Because the project is expected to generate fewer than 50 peak hour trips, only a focused study is required under the *City's Guidance for the Preparation of Traffic Operational Analysis*, 2019.

Site Access

As part of the construction of the project, a driveway would be constructed off Meadowbrook Court at the southern side of the project site.

Emergency Vehicle Access

Based on the site plan dimensions, on-site circulation is adequate for emergency vehicle access, such as fire trucks and ambulances. There is a fire hydrant at the corner of West Steele Lane/Meadowbrook Court. Auto-turn exhibits of a fire truck maneuvering on-site is enclosed.

Sight Distance

Sight distances along Meadowbrook Court at the proposed new driveway were evaluated based on sight distance criteria contained in the *Highway Design Manual*, 6th Edition published by Caltrans. The recommended sight distances along the Meadowbrook Court at the private project driveway are based on stopping sight distance.

Based on a design speed of 25 mph, the minimum stopping sight distance needed is 150 feet. During the site visit, there was a vehicle parked where the proposed driveway would be, and sight distance was limited due to vehicles parked on either side of the proposed driveway. To ensure adequate sight lines, it is recommended that the curb be painted red on either side of the driveway for a length of 22 feet, or one standard vehicle length. Additionally, it is recommended that any signage or landscaping planned at the driveway be outside of the driver's vision triangle to maintain adequate sight lines.

Finding – Sight distance based on the posted speed limit at the proposed driveway was limited due to parked vehicles.

Recommendation – Parking should be prohibited through use of red-painted curb for 22 feet, or the length of one standard parking space, on either side of the project driveway to ensure adequate sight distance. Additionally, the project should be designed to keep any project signage or landscaping outside of the driver's vision triangle.

Left-Turn Lane Warrant

The need for a left-turn lane on West Steele Lane at Meadowbrook Court was evaluated based on criteria contained in the *Intersection Channelization Design Guide*, National Cooperative Highway Research Program (NCHRP) Report No. 279, Transportation Research Board, 1985, as well as an update of the methodology developed by the Washington State Department of Transportation and published in the *Method For Prioritizing Intersection Improvements*, January 1997.

Existing peak hour volumes at West Steele Lane/Range Avenue as well as safety criteria were used. The trip generation for the existing single-family and multifamily units that are accessible via Meadowbrook Court were assumed based on City GIS parcel maps, and 62 multifamily units and two single family units were assumed. Based on counts along West Steele Lane, it was assumed 60 percent of trips would travel to and from Meadowbrook Court from the east and 40 percent to and from the west. Under Existing plus Project conditions, which includes traffic associated with the existing residential units that are accessible via Meadowbrook Court and the proposed project, a left-turn lane is **not** warranted on West Steele Lane at Meadowbrook Court during either of the peak periods evaluated. The left-turn lane warrant spreadsheets and counts used are enclosed for reference.

Non-Auto Modes

Pedestrian Facilities

Given the proximity of the Coddington Mall and rapid bus stops within one-half mile surrounding the site, it is anticipated that some project residents will want to walk, bicycle, and/or use transit for trips from and to the project site. The site plan includes plans for construction of sidewalk and landscape buffering on the project frontage on Meadowbrook Court, which will provide a connection between existing sidewalks south of the project site and on West Steele Lane. The inclusion of a landscape buffer results in an indirect connection to the existing sidewalk to the south of the site. Because buffers are typically not required on minor streets it appears that the landscape buffer could be eliminated. If it is to be retained it should be tapered at the south end of the site so that there is a smoother transition to the existing sidewalk.

The existing curb ramp on the project corner of Meadowbrook Court/West Steele Lane would be reconstructed to match the new curbline along Meadowbrook Court after widening the street along the project frontage by four

feet. Additionally, the site plan includes a streetlight just south of West Steele Lane on Meadowbrook Court. Based on City staff comments, it is recommended that an additional streetlight be installed near the project driveway on Meadowbrook Court. To ensure adequate sight distance, the streetlight placement should be designed to not limit visibility of drivers exiting the driveway.

The existing sidewalk on West Steele Lane along the project frontage will be reconstructed and the existing driveway on West Steele Lane on the project frontage would be closed and converted to sidewalk.

Finding – Planned sidewalks and street lighting along Meadowbrook Court, along with existing facilities, are adequate for anticipated demand and will improve connectivity from existing conditions.

Recommendation – Either the sidewalk along the project frontage should be contiguous with the curb and gutter or the transition at the south end should be tapered to provide a more standard and comfortable connection to the existing sidewalk on the southern end of Meadowbrook Court.

Recommendation – In addition to the planned streetlight at the corner of Steele Lane/Meadowbrook Court, a streetlight should also be installed near the project driveway.

Bicycle Facilities

Existing bicycle facilities, including bike lanes on West Steele Lane, together with shared use of minor streets, provide adequate access for bicyclists. The proposed addition of bicycle lanes along some of the streets surrounding the project site as well as extension of the SMART trail north of the Santa Rosa North Station will provide adequate access for bicyclists.

Finding – Bicycle facilities serving the project are adequate and will be improved with the planned completion of additional facilities in the future.

Transit Facilities

Existing transit routes are acceptable to accommodate project-generated transit trips. Existing bus stops are within an acceptable walking distance of the site, and accessible via sidewalks.

Finding – Transit facilities serving the project site are adequate.

Vehicular Parking

The proposed project would provide 36 off-street parking spaces. The City of Santa Rosa's City Code stipulates the City's parking requirements for new developments. According to Zoning Code Section 20-36.050, "Parking requirements for projects located within the Downtown and North Santa Rosa Station Area Specific Plan boundaries may be reduced by the review authority, as a condition of project approval or Minor Conditional Use Permit, when supported by a parking study." Because the project site is within the *North Santa Rosa Station Area Specific Plan* boundary, the parking requirement for the 32 market-rate units of 1.5 spaces per unit is lower than for general multifamily dwelling units. Additionally, the four affordable units would have a required parking rate of one space per unit. Based on the applicable parking requirements, the proposed project would need 52 parking spaces, or 16 spaces more than are proposed. According to the City Code, "The review authority may approve a decrease in parking spaces after first making the following finding: (C)(2)(a) The number of parking spaces approved will be sufficient for its safe, convenient and efficient operation of the use, and will be compatible with the neighboring properties." Since the proposed parking supply is deficient to meet City requirements, the project's potential parking demand was evaluated.

Standard parking demand rates published by ITE in *Parking Generation*, 5th Edition, 2019 were applied to the proposed project. Since the project site is within one-half mile of the SMART station and within walking distance of the Coddington Mall and Transit Center, the land use "Multifamily Residential Housing (Low-Rise) in a Dense Multi-Use Urban Area within One-Half Mile of Rail Transit" (LU 220) was applied. Based on ITE rates, the 36-unit project would generate a peak parking demand of 39 parking spaces, which is three spaces more than the proposed parking supply, but 13 spaces fewer than required based on application of City code.

It is noted that the proposed project includes plans to provide unbundled parking, which could decrease parking demand and provide a cost saving to tenants. This makes parking a separate option in lease agreements and allows residents to choose if they want to lease a parking space or not. Residential parking spaces are typically bundled into the lease amounts, so residents may not realize the high cost of building, operating, and maintaining parking. Further, adding parking as a separate line item will help tenants understand the cost savings associated with reducing their parking needs. This parking demand strategy is estimated to reduce parking demand by 10 to 15 percent based on the Metropolitan Transportation Commission (MTC)'s *Reforming Parking Policies to Support Smart Growth*. To be conservative, applying the lower potential parking demand percentage decrease from unbundled parking (10 percent) the project would generate four fewer spaces than compared to ITE rates, for a total peak parking demand of 35 spaces. Compared to the proposed parking supply, the parking demand would be one less space than proposed with unbundled parking deductions applied.

Finding – Based on City requirements, the proposed parking supply would be deficient by 16 spaces. However, given the site's proximity to rail transit, application of ITE standard parking demand rates together with the project's proposed use of unbundled parking, the anticipated peak parking demand would be one space less than the proposed supply. Under these assumptions, the proposed parking supply would be expected to be adequate to meet the project's demand.

Bicycle Parking

According to the City Code, the project would be required to provide bicycle parking spaces at a rate of one space per four units unless units have a private garage or storage space for a bicycle. Based on the proposed number of units, the project would be required to provide at least nine bicycle parking spaces. As proposed, there would be nine long-term spaces and nine bicycle rack spaces, for a total of 18 bicycle parking spaces on-site; this would be more than adequate to meet City requirements. As the proposed supply of bicycle parking spaces is double the number required based on City requirements, it is anticipated that this would encourage the use of active modes of transportation rather than vehicular ownership, further reducing parking demand associated with the project.

Conclusions and Recommendations

- As proposed, the project would generate 264 trips daily, including 17 trips in the a.m. peak hour and 20 trips during the p.m. peak hour.
- Emergency vehicle access would be adequate.
- Sight lines at the proposed driveway location would be limited by vehicles parked on the project side of Meadowbrook Court. It is recommended that the curb be painted red for 22 feet, or one parking space length, on either side of the project driveway to ensure adequate sight lines. Additionally, any project landscaping and signage at the driveway should be placed outside the driver's vision triangle.
- A left-turn lane would not be warranted on West Steele Lane at Meadowbrook Court, with or without project generated trips.

- With the construction of the proposed project, existing sidewalks on the project frontage on West Steele Lane would be improved, and the existing driveway eliminated. New sidewalk would be constructed on the Meadowbrook Court frontage. It is recommended that this sidewalk be placed contiguous to the curb and gutter to match facilities to the south or else realigned at the southerly end of the site to provide a transition to the connection with existing facilities. In addition to the planned streetlight at Steele Lane/Meadowbrook Court, a streetlight should be placed near the project driveway.
- Existing bicycle and transit facilities serving the site are adequate.
- The proposed supply of vehicle parking spaces is deficient by 16 spaces compared to City requirements; however, it is adequate to meet the peak demand projected by applying standard parking demand rates combined with reductions in demand due to unbundled parking. The number of bicycle parking spaces on-site as proposed is double the number needed to meet City requirements, which would be expected to contribute to lower vehicle ownership.

Thank you for giving W-Trans the opportunity to provide these services. Please call if you have any questions.

Sincerely,

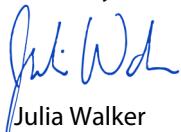

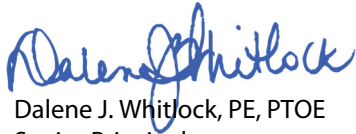
Julia Walker
Assistant Planner

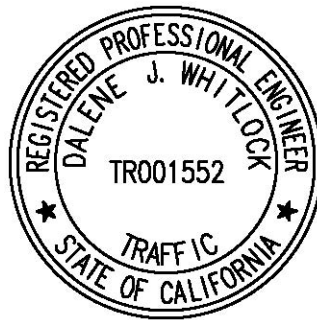
Dalene J. Whitlock, PE, PTOE
Senior Principal

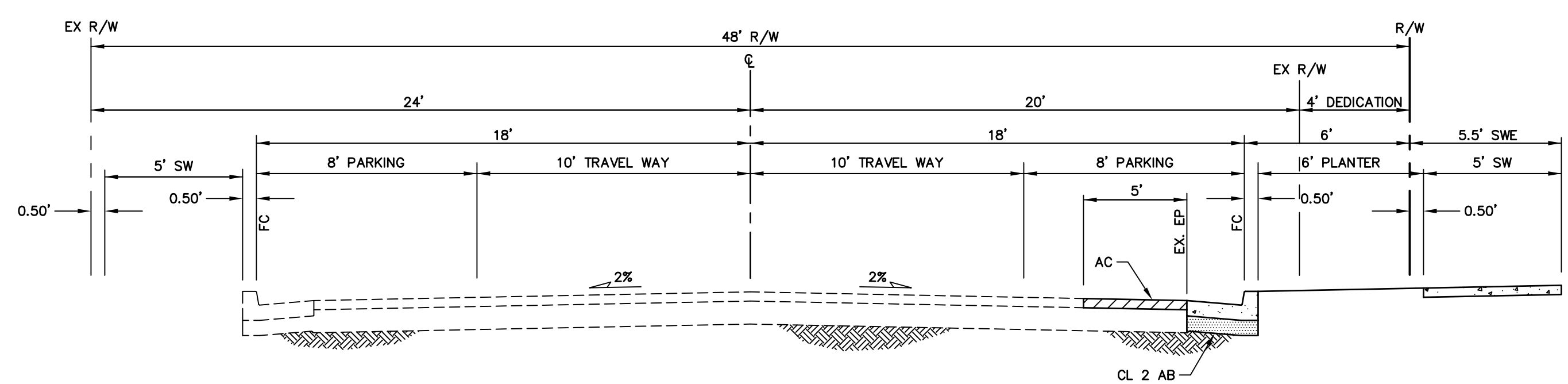
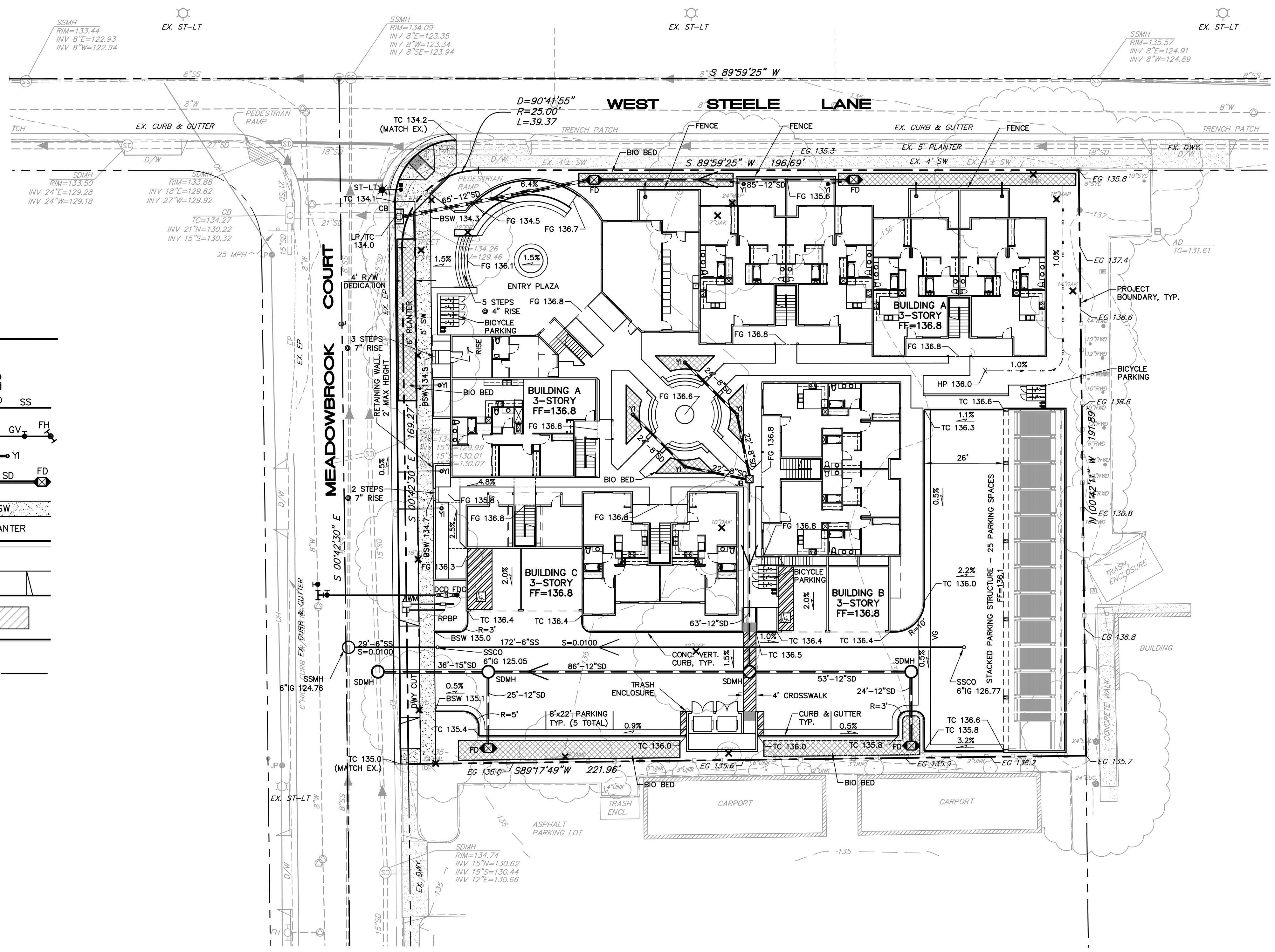
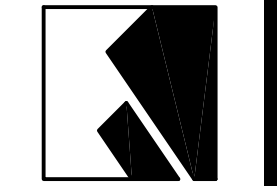

DJW/jaw/SRO547.L1

Enclosures: Site Plan; Auto-Turn Exhibit; Left-Turn Lane Warrant Spreadsheets; Counts



MINOR STREET - PUBLIC
MEADOWBROOK COURT

NO SCALE

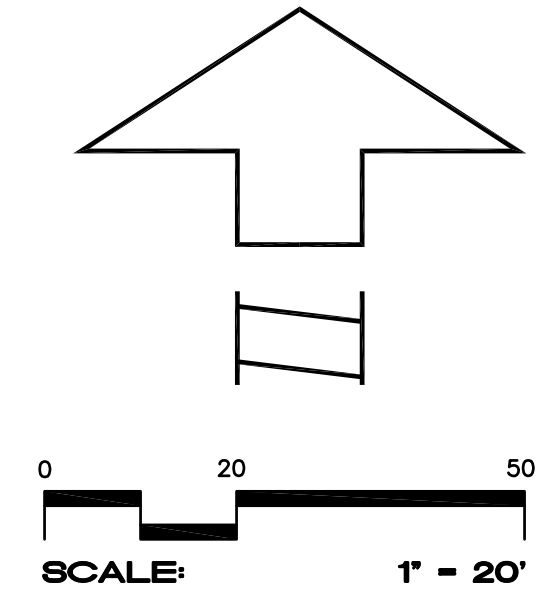

LEGEND

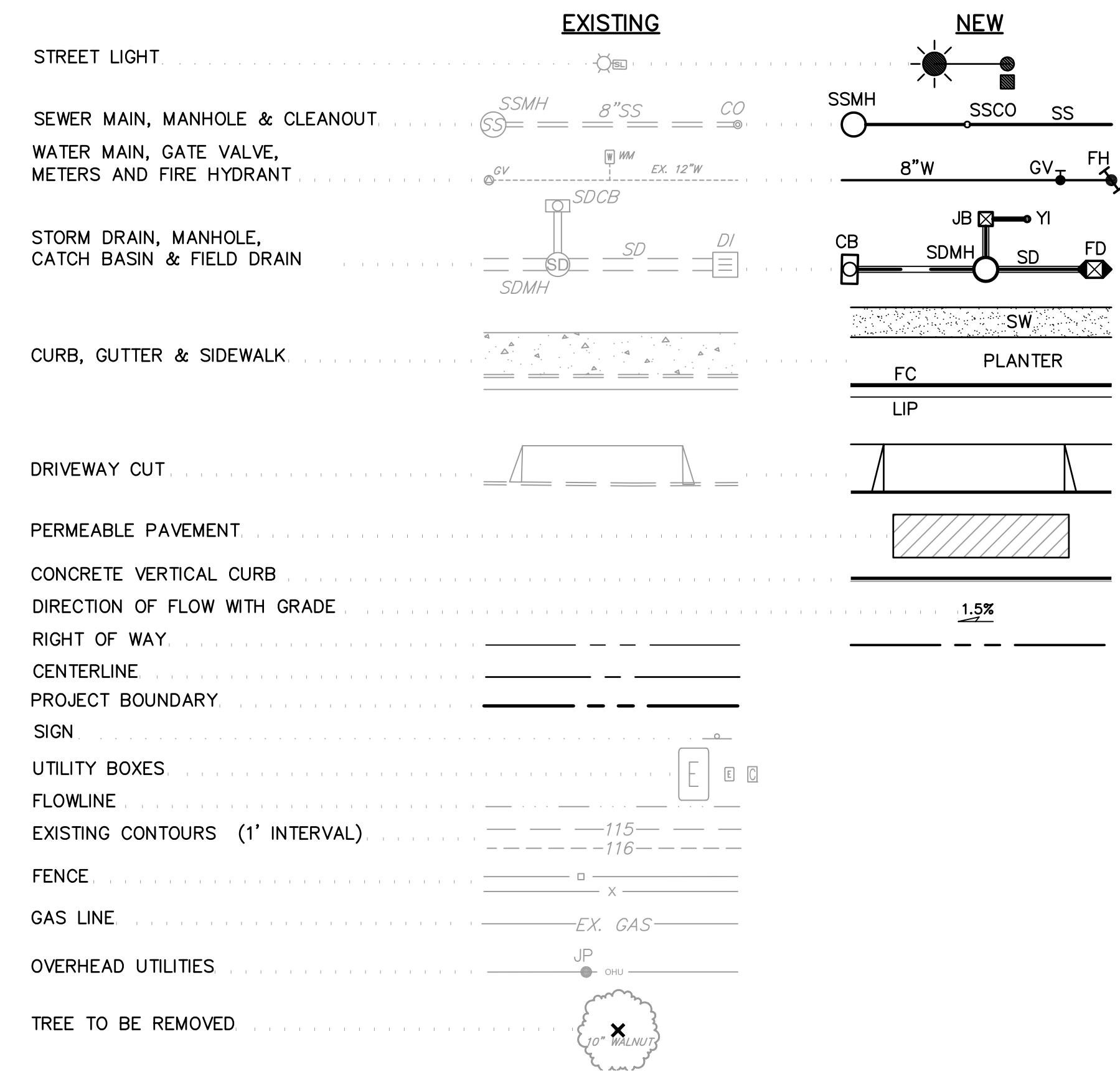

ABBREVIATIONS

ADA	AMERICANS WITH DISABILITIES ACT
APN	ASSESSORS PARCEL NUMBER
BSW	BACK OF SIDEWALK
CB	CATCH BASIN
CONC	CONCRETE
DCD	DOUBLE CHECK DETECTOR
DN	DOCUMENT NUMBER
EG	EXISTING GRADE
EP	EDGE OF PAVEMENT
EX	EXISTING
FD	FIELD DRAIN
FDC	FIRE DEPARTMENT CONNECTION
FF	FINISH FLOOR
FG	FINISH GRADE
FH	FIRE HYDRANT
FL	FLOW LINE
GV	GATE VALVE
HP	HIGH POINT
IG	INVERT GRADE
JB	JUNCTION BOX
LP	LOW POINT
R	RADIUS
R/W	RIGHT OF WAY
RPBP	REDUCED PRESSURE BACKFLOW PREVENTOR
S	SLOPE OR SOUTH
SDMH	STORM DRAIN MANHOLE
SO	SIDE OPENING
SS	SANITARY SEWER
SSCO	SANITARY SEWER CLEAN OUT
SSMH	SANITARY SEWER MANHOLE
ST-LT	STREET LIGHT
SW	SIDEWALK
SWE	SIDEWALK EASEMENT
TC	TOP OF CURB
TYP	TYPICAL
VERT	VERTICAL
VG	VALLEY GUTTER
W	WATER OR WEST
WM	WATER METER
YI	YARD INLET

S:\2019\PROJ\19-107\Drawings\Site\DWG\Site\DWG\SSG\SSG.dwg 11/15/2019 10:56:08 AM

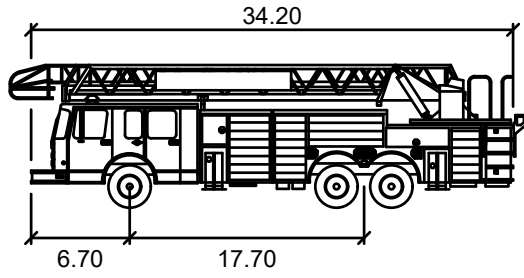

FIRE-LADDER

- Width : 8.20
- Track : 8.20
- Lock to Lock Time : 6.0
- Steering Angle : 36.8

feet

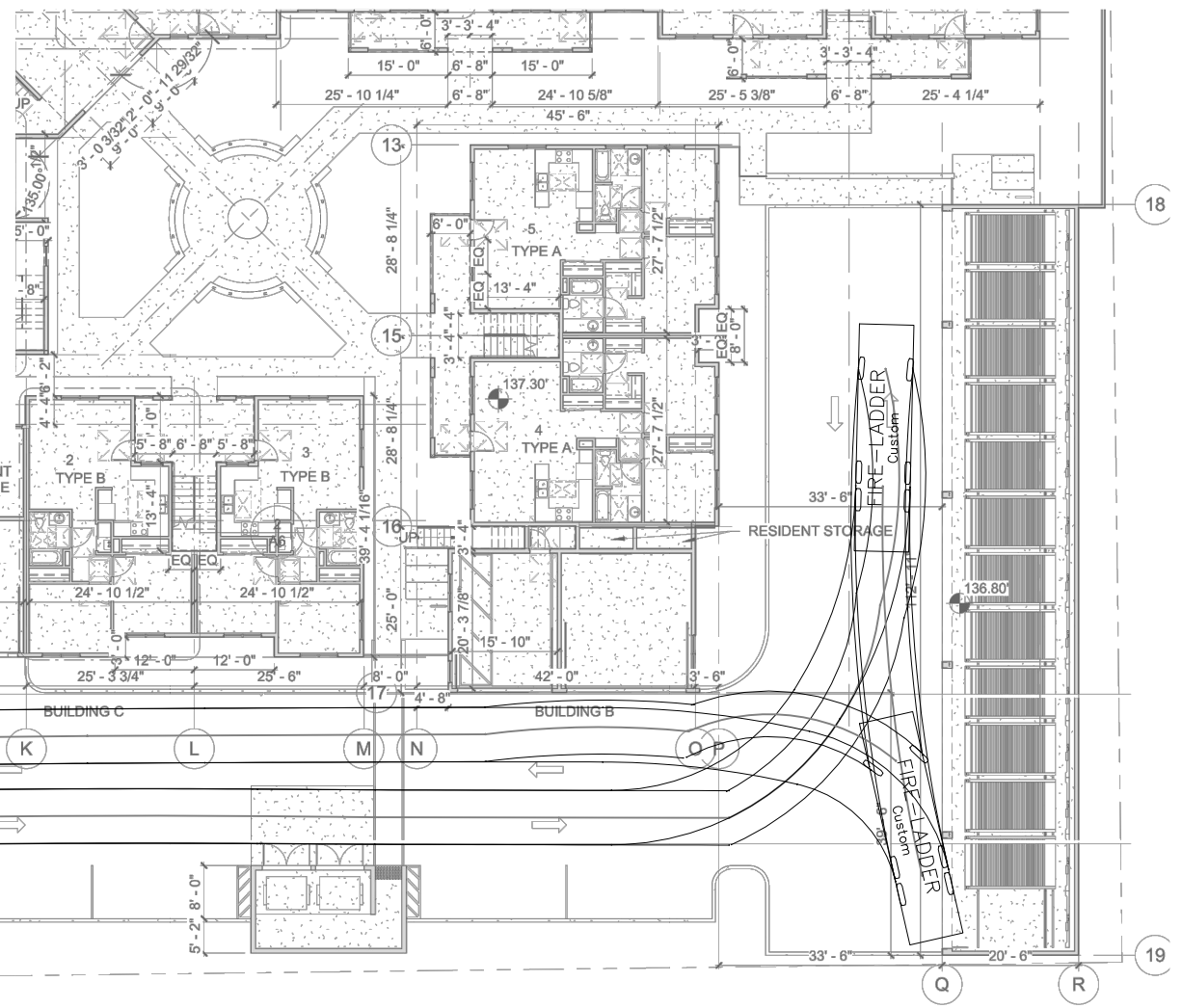

Turn Lane Warrant Analysis - Tee Intersections

Study Intersection: West Steele Lane/Meadowbrook Court
 Study Scenario: AM Existing

Direction of Analysis Street: East/West

Cross Street Intersects: From the South

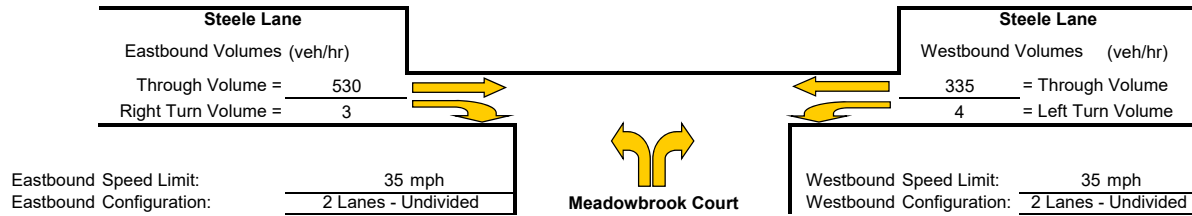

Eastbound Right Turn Lane Warrants

1. Check for right turn volume criteria

Thresholds not met, continue to next step

2. Check advance volume threshold criteria for turn lane

Advancing Volume Threshold	AV =	1027.6
Advancing Volume	Va =	533
If $AV < Va$ then warrant is met		
		No

Right Turn Lane Warranted: NO

Eastbound Right Turn Taper Warrants

(evaluate if right turn lane is unwarranted)

1. Check taper volume criteria

NOT WARRANTED - Less than 20 vehicles

2. Check advance volume threshold criteria for taper

Advancing Volume Threshold	AV =	-
Advancing Volume	Va =	533
If $AV < Va$ then warrant is met		
		-

Right Turn Taper Warranted: NO

Westbound Left Turn Lane Warrants

Percentage Left Turns %lt	1.2 %
Advancing Volume Threshold AV	1025 veh/hr
If $AV < Va$ then warrant is met	

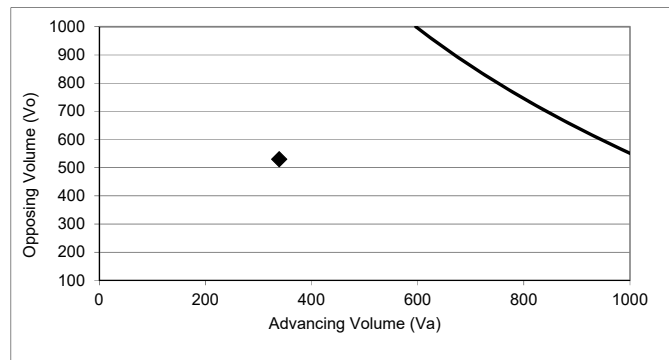

◆ Study Intersection
 Two lane roadway warrant threshold for: 35 mph
 Turn lane warranted if point falls to right of warrant threshold line

Left Turn Lane Warranted: NO

Methodology based on Washington State Transportation Center Research Report *Method For Prioritizing Intersection Improvements*, January 1997.
 The right turn lane and taper analysis is based on work conducted by Cottrell in 1981.
 The left turn lane analysis is based on work conducted by M.D. Harmelink in 1967, and modified by Kikuchi and Chakroborty in 1991.

Turn Lane Warrant Analysis - Tee Intersections

Study Intersection: West Steele Lane/Meadowbrook Court

Study Scenario: AM Existing plus Project

Direction of Analysis Street: East/West

Cross Street Intersects: From the South

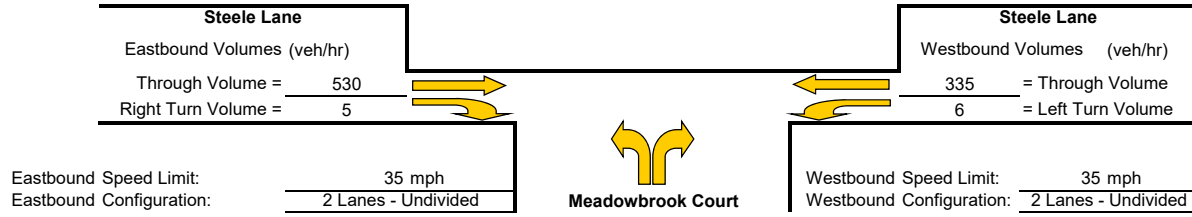

Eastbound Right Turn Lane Warrants

1. Check for right turn volume criteria

Thresholds not met, continue to next step

2. Check advance volume threshold criteria for turn lane

Advancing Volume Threshold	AV =	1012.6
Advancing Volume	Va =	535
If $AV < Va$ then warrant is met		
		No

Right Turn Lane Warranted: NO

Eastbound Right Turn Taper Warrants

(evaluate if right turn lane is unwarranted)

1. Check taper volume criteria

NOT WARRANTED - Less than 20 vehicles

2. Check advance volume threshold criteria for taper

Advancing Volume Threshold	AV =	-
Advancing Volume	Va =	535
If $AV < Va$ then warrant is met		
		-

Right Turn Taper Warranted: NO

Westbound Left Turn Lane Warrants

Percentage Left Turns %lt	1.8 %
Advancing Volume Threshold AV	942 veh/hr
If $AV < Va$ then warrant is met	

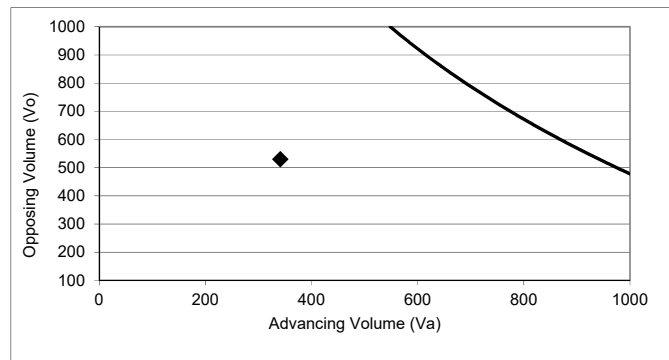

◆ Study Intersection

Two lane roadway warrant threshold for: 35 mph

Turn lane warranted if point falls to right of warrant threshold line

Left Turn Lane Warranted: NO

Methodology based on Washington State Transportation Center Research Report *Method For Prioritizing Intersection Improvements*, January 1997.

The right turn lane and taper analysis is based on work conducted by Cottrell in 1981.

The left turn lane analysis is based on work conducted by M.D. Harmelink in 1967, and modified by Kikuchi and Chakroborty in 1991.

Turn Lane Warrant Analysis - Tee Intersections

Study Intersection: West Steele Lane/Meadowbrook Court
 Study Scenario: PM Existing

Direction of Analysis Street: East/West

Cross Street Intersects: From the South

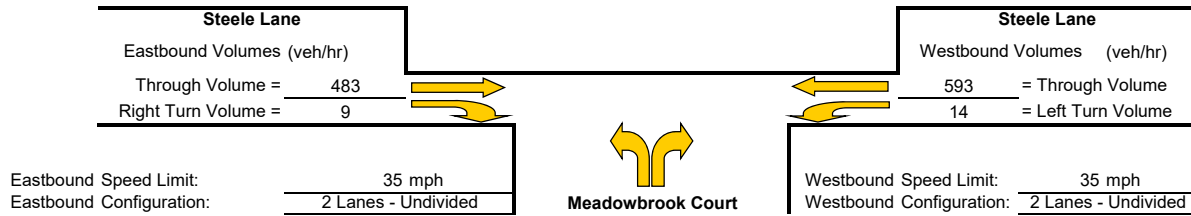

Eastbound Right Turn Lane Warrants

1. Check for right turn volume criteria

Thresholds not met, continue to next step

2. Check advance volume threshold criteria for turn lane

Advancing Volume Threshold AV = 982.6
 Advancing Volume Va = 492
 If $AV < Va$ then warrant is met No

Right Turn Lane Warranted: NO

Eastbound Right Turn Taper Warrants

(evaluate if right turn lane is unwarranted)

1. Check taper volume criteria

NOT WARRANTED - Less than 20 vehicles

2. Check advance volume threshold criteria for taper

Advancing Volume Threshold AV = -
 Advancing Volume Va = 492
 If $AV < Va$ then warrant is met -

Right Turn Taper Warranted: NO

Westbound Left Turn Lane Warrants

Percentage Left Turns %lt 2.3 %
 Advancing Volume Threshold AV 923 veh/hr
 If $AV < Va$ then warrant is met

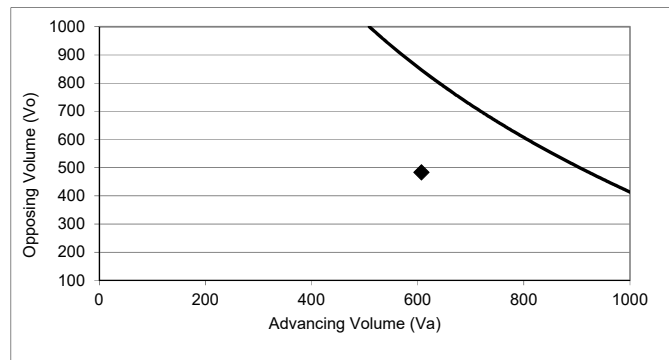

◆ Study Intersection
 Two lane roadway warrant threshold for: 35 mph
 Turn lane warranted if point falls to right of warrant threshold line

Left Turn Lane Warranted: NO

Methodology based on Washington State Transportation Center Research Report *Method For Prioritizing Intersection Improvements*, January 1997.
 The right turn lane and taper analysis is based on work conducted by Cottrell in 1981.
 The left turn lane analysis is based on work conducted by M.D. Harmelink in 1967, and modified by Kikuchi and Chakroborty in 1991.

Turn Lane Warrant Analysis - Tee Intersections

Study Intersection: West Steele Lane/Meadowbrook Court

Study Scenario: PM Existing plus Project

Direction of Analysis Street: East/West

Cross Street Intersects: From the South

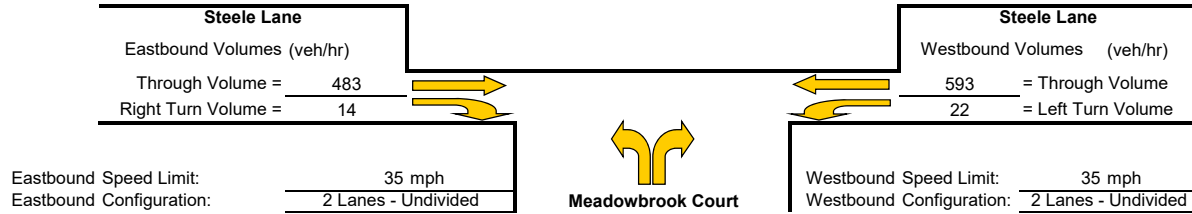

Eastbound Right Turn Lane Warrants

1. Check for right turn volume criteria

Thresholds not met, continue to next step

2. Check advance volume threshold criteria for turn lane

Advancing Volume Threshold AV = 945.1
Advancing Volume Va = 497
If $AV < Va$ then warrant is met No

Right Turn Lane Warranted: NO

Eastbound Right Turn Taper Warrants

(evaluate if right turn lane is unwarranted)

1. Check taper volume criteria

NOT WARRANTED - Less than 20 vehicles

2. Check advance volume threshold criteria for taper

Advancing Volume Threshold AV = -
Advancing Volume Va = 497
If $AV < Va$ then warrant is met -

Right Turn Taper Warranted: NO

Westbound Left Turn Lane Warrants

Percentage Left Turns %lt 3.6 %

Advancing Volume Threshold AV 790 veh/hr

If $AV < Va$ then warrant is met

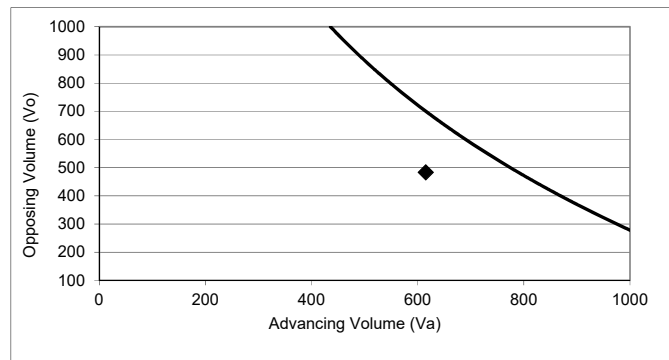

◆ Study Intersection

Two lane roadway warrant threshold for: 35 mph

Turn lane warranted if point falls to right of warrant threshold line

Left Turn Lane Warranted: NO

Methodology based on Washington State Transportation Center Research Report *Method For Prioritizing Intersection Improvements*, January 1997.

The right turn lane and taper analysis is based on work conducted by Cottrell in 1981.

The left turn lane analysis is based on work conducted by M.D. Harmelink in 1967, and modified by Kikuchi and Chakroborty in 1991.

INTERSECTION TURNING MOVEMENT COUNTS

PREPARED BY: AimTD LLC. tel: 714 253 7888 cs@aimtd.com

DATE: Tue, Feb 19, 19	LOCATION: NORTH & SOUTH: EAST & WEST:	Santa Rosa Range W Steele	PROJECT #: SC LOCATION #: 66 CONTROL: SIGNAL
--------------------------	---	---------------------------------	--

NOTES: AM
PM
MD
OTHER
OTHER

PM SB queue

← W

▲ N
▼ S

E →

Add U-Turns to Left Turns

LANES:	NORTHBOUND			SOUTHBOUND			EASTBOUND			WESTBOUND			TOTAL
	Range			Range			W Steele			W Steele			
	NL 1	NT 2	NR 0	SL 1	ST 2	SR 0	EL 1	ET 1	ER 0	WL 1	WT 1	WR 0	

U-TURNS				
NB	SB	EB	WB	TTL
0	0	0	0	0

	NORTHBOUND			SOUTHBOUND			EASTBOUND			WESTBOUND			TOTAL	
	NL	NT	NR	SL	ST	SR	EL	ET	ER	WL	WT	WR		
AM	7:00 AM	7	27	9	5	8	1	9	74	7	6	43	2	198
	7:15 AM	4	25	2	2	14	3	6	100	5	6	51	7	225
	7:30 AM	11	43	8	9	23	8	6	101	10	5	75	5	304
	7:45 AM	13	57	7	5	40	4	12	118	7	13	57	5	338
	8:00 AM	15	58	7	11	37	8	16	95	19	9	93	11	379
	8:15 AM	15	59	3	5	56	5	16	119	12	2	52	12	356
	8:30 AM	12	51	7	10	36	6	7	98	14	5	59	10	315
	8:45 AM	15	56	11	11	34	6	12	96	12	4	58	9	324
	VOLUMES	92	376	54	58	248	41	84	801	86	50	488	61	2,439
	APPROACH %	18%	72%	10%	17%	71%	12%	9%	82%	9%	8%	81%	10%	
APP/DEPART	522	/	521	347	/	384	971	/	913	599	/	621	0	
BEGIN PEAK HR	7:45 AM													
VOLUMES	55	225	24	31	169	23	51	430	52	29	261	38	1,388	
APPROACH %	18%	74%	8%	14%	76%	10%	10%	81%	10%	9%	80%	12%		
PEAK HR FACTOR	0.950			0.845			0.906			0.726			0.916	
APP/DEPART	304	/	314	223	/	250	533	/	485	328	/	339	0	
MIDDAY	11:30 AM	18	39	13	22	69	5	9	76	14	17	59	13	354
	11:45 AM	11	50	13	15	57	8	8	62	13	12	78	12	339
	12:00 PM	26	40	8	14	74	10	9	75	14	19	85	19	393
	12:15 PM	29	58	11	13	74	7	11	83	13	14	74	22	409
	12:30 PM	25	41	8	7	70	8	12	64	10	15	66	17	343
	12:45 PM	19	59	10	12	66	6	12	77	12	13	77	13	376
	1:00 PM	22	69	5	3	66	5	14	68	10	11	69	16	358
	1:15 PM	23	53	6	11	67	6	15	72	4	13	68	17	355
	VOLUMES	173	409	74	97	543	55	90	577	90	114	576	129	2,927
	APPROACH %	26%	62%	11%	14%	78%	8%	12%	76%	12%	14%	70%	16%	
APP/DEPART	656	/	628	695	/	747	757	/	748	819	/	804	0	
BEGIN PEAK HR	12:00 PM													
VOLUMES	99	198	37	46	284	31	44	299	49	61	302	71	1,521	
APPROACH %	30%	59%	11%	13%	79%	9%	11%	76%	13%	14%	70%	16%		
PEAK HR FACTOR	0.852			0.921			0.916			0.882			0.930	
APP/DEPART	334	/	313	361	/	394	392	/	382	434	/	432	0	
PM	4:00 PM	26	51	6	21	96	15	12	89	21	21	99	11	468
	4:15 PM	31	42	16	21	81	9	10	82	14	18	102	16	442
	4:30 PM	29	39	10	18	95	10	10	85	14	16	109	12	447
	4:45 PM	22	48	10	26	112	20	11	99	28	17	121	14	528
	5:00 PM	20	48	9	17	128	22	13	82	13	19	107	12	490
	5:15 PM	29	50	13	19	106	17	4	94	12	19	107	15	485
	5:30 PM	25	44	14	16	106	7	14	100	22	19	110	15	492
	5:45 PM	15	33	16	5	92	18	6	84	17	25	108	14	433
	VOLUMES	197	355	94	143	816	118	80	715	141	154	863	109	3,785
	APPROACH %	30%	55%	15%	13%	76%	11%	9%	76%	15%	14%	77%	10%	
APP/DEPART	646	/	544	1,077	/	1,111	936	/	952	1,126	/	1,178	0	
BEGIN PEAK HR	4:45 PM													
VOLUMES	96	190	46	78	452	66	42	375	75	74	445	56	1,995	
APPROACH %	29%	57%	14%	13%	76%	11%	9%	76%	15%	13%	77%	10%		
PEAK HR FACTOR	0.902			0.892			0.891			0.946			0.945	
APP/DEPART	332	/	288	596	/	601	492	/	499	575	/	607	0	

NB	SB	EB	WB	TTL
0	0	0	0	0
0	0	0	0	0
0	0	0	0	0
0	0	0	0	0
0	0	0	0	0
0	0	0	0	0
0	0	0	0	0
0	0	0	0	0
0	0	0	0	0
0	0	0	0	0

NB	SB	EB	WB	TTL
0	0	0	0	0
0	0	0	0	0
0	0	0	0	0
0	0	0	0	0
0	0	0	0	0
0	0	0	0	0
0	0	0	0	0
0	0	0	0	0
0	0	0	0	0
0	0	0	0	0

