

1650 West Steele Lane Apartments Santa Rosa, CA

Addendum to the April 2012 North Santa Rosa Station Area
Specific Plan Draft EIR and the June 2012 Final EIR



**J. Kapolchok
+ Associates**

Land Use Planning
Urban Design

1500 Manzanita Avenue
Santa Rosa, CA 95404
TEL: 707.526.8939
FAX: 707.526.8985

eMAIL: jkapolchok@sbcglobal.net

eMAIL: jkapolchok@sonomacountylanduse.com

March
2022
Revised
June
2022

CHAPTER 1: OVERVIEW

1.1 Applications/Entitlement Processing

Hedgpeth Architects has filed a Minor Design Review and a Minor Use Permit application for the 1650 West Steele Lane Apartments project (the Project). The applications were filed on behalf of the property owner, McBride Lane Apartments LLC, Patrick O’Neil, managing partner. The Project is located at 1650 West Steele Lane in the Northwest quadrant of the city of Santa Rosa. The site is within the boundaries of the North Santa Rosa Station Area Specific Plan (NSRSASP). The area encompassed by the NSRSASP has been designated a Housing Opportunity Area by the City of Santa Rosa under the City’s Resilient City Development Measure. As depicted in Figure 1 below, the project site is less than ¼-mile northeast of the Sonoma-Marin Area Rail Transit (SMART) Guerneville Road rail stop in North Santa Rosa.

The Project proposes 36 apartment units, four of which will be affordable through deed restrictions, and a two-level automated parking structure. The Project includes a 35% State Density Bonus and a 65% City of Santa Rosa Density Bonus. Per the City’s Resilient City Development Measures (Zoning Code Chapter 20-16) and the City’s Density Bonus Ordinance (Ordinance No. ORD-2019-002: Zoning Code Chapter 20-31) processing entitlements consist of:

- Pre-application neighborhood meeting. Meeting held January 15, 2020
- Concept Design Review. Meeting held March 5, 2020
- Minor Design Review before the Zoning Administrator (multi-family development), and
- Minor Conditional Use Permit (Density Bonus application) before the Zoning Administrator.

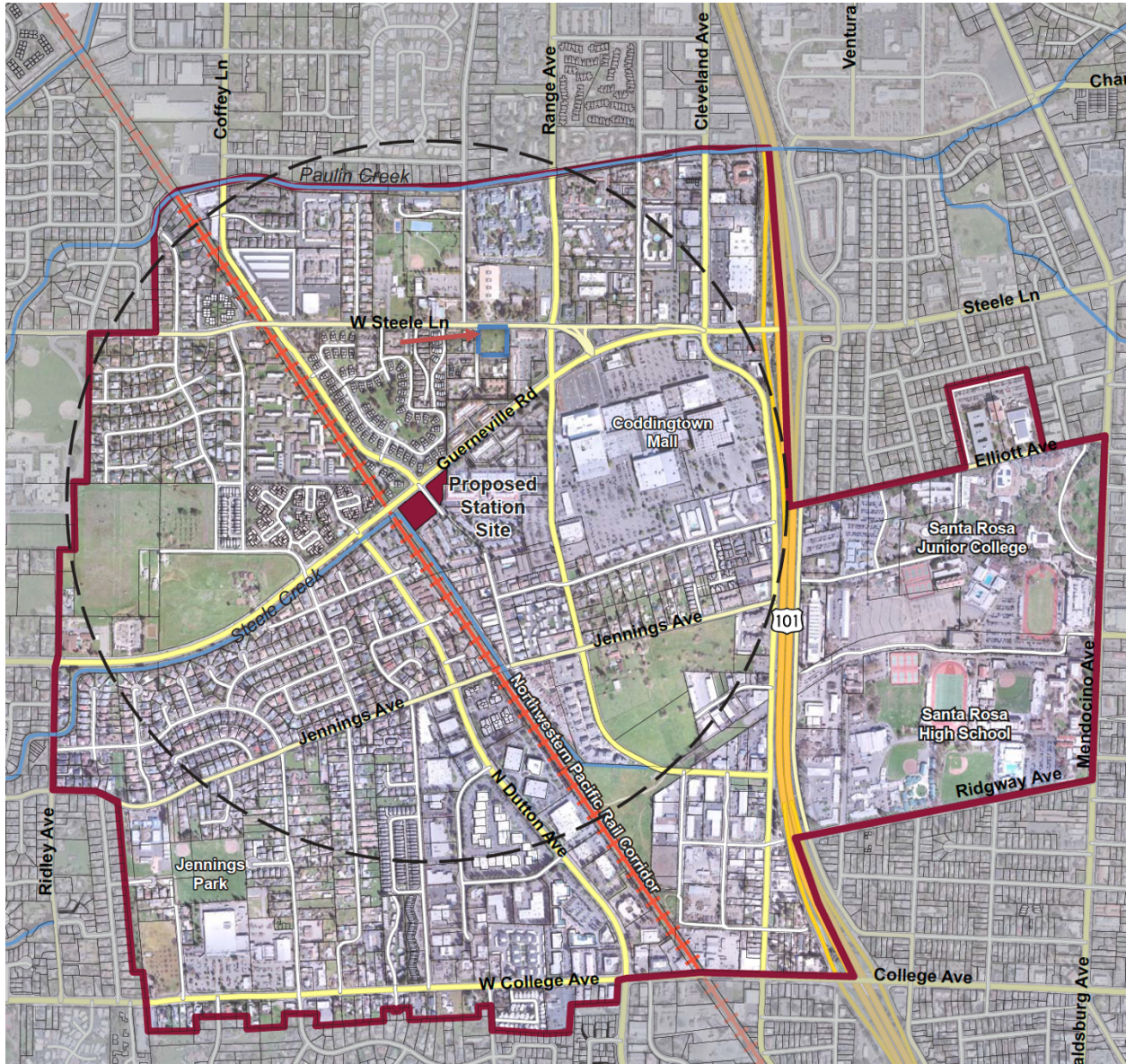

Figure 1: North Santa Rosa Station Area Specific Plan Area Map

1.2 Project Policy/Ordinance Context

Sonoma-Marín Area Rail Transit (SMART) has established commuter rail service in Sonoma and Marin counties; the Guerneville Road rail stop (North Station) is located southwest of the intersection of Guerneville Road and Herbert Lane, which lies approximately 560 ft east of North Dutton Avenue. A primary objective of the NSRSASP is to support future rail transit by increasing the number of residents and employees within walking distance to the North Station rail stop. The 1650 West Steele Lane Apartments project is designed to maximize the residential density of the site thereby increasing, to the extent possible, the residential population within a quarter of a mile of the North Station.

The Santa Rosa City Council adopted the NSRSASP on September 18, 2012. The Plan's Figure 2.8: Opportunities Diagram designates the site as a Development Opportunity Site. The NSRSASP Land Use Map (Specific Plan Figure 4.1) designates the Project site as Medium Density Residential 8 – 18 units per acre.

The Council of the City of Santa Rosa adopted the Resilient City Development Measures, which subsequently amended Zoning Code Chapter 20-16. Said measures established development opportunity areas, which in turn became subject to a streamlined entitlement process. The City Council of the City of Santa Rosa also adopted Ordinance No. ORD-2019-002 on January 15, 2019. Said ordinance allowed, among other things, supplemental density bonus of up to 100% within the boundaries of the Downtown Station Area Plan and the North Santa Rosa Station Area Specific Plan. A Negative Declaration was certified by Resolution RES-2019-002 of the City Council for Ordinance No. ORD-2019-002.

The Project use, multi-family housing, is a permitted use under the R-3-15-SA zoning district. The density of the Project is allowed per the housing opportunity and density bonus measures adopted by the City Council. The Project design needs to be consistent with all applicable design/development standards established in the NSRSASP. Likewise, the full Project needs to be found consistent with the General Plan and the NSRSASP.

The site's R-3-15-SA zoning district was established upon the adoption of the NSRSASP. The EIR for the North Santa Rosa Station Area Specific Plan was used as the underlying environmental document. The mitigated Negative Declaration (MND) adopted for the supplemental density bonus found the density increase provision consistent with the Downtown Station Area Specific Plan, the North Santa Rosa Station Area Specific Plan and the General Plan.

1.3 CEQA Standard

This Addendum has been prepared pursuant to CEQA and the CEQA Guidelines¹. Specifically, CEQA Guidelines Section 15164, subdivision (a), which provides: *“The lead agency or responsible agency shall prepare an addendum to a previously certified EIR if some changes or additions are necessary but none of the conditions described in Section 15162 calling for the preparation of a subsequent EIR have occurred.*

CEQA Guidelines Sections 15164 further states that: An Addendum need not be circulated for public review or comment, but must be considered by the agency before making its decision on the project. (CEQA Guidelines, §15164, subdivisions. (c) and (d).)

CEQA Guidelines Section 15162: Section 15162 subdivision (a), provides that:

When an EIR has been certified or a negative declaration adopted for a project, no subsequent EIR shall be prepared for that project unless the lead agency determines, on the basis of substantial evidence in the light of the whole record, one or more of the following exist:

¹ California Code of Regulations, Title 14, §15000 et seq.

- (1) Substantial changes are proposed in the project which will require major revisions of the previous EIR or negative declaration due to the involvement of new significant environmental effects or a substantial increase in the severity of previously identified significant effects;
- (2) Substantial changes occur with respect to the circumstances under which the project is undertaken which will require major revisions of the previous EIR or Negative Declaration due to the involvement of new significant environmental effects or a substantial increase in the severity of previously identified significant effects; or
- (3) New information of substantial importance, which was not known and could not have been known with the exercise of reasonable diligence at the time the previous EIR was certified as complete or the Negative Declaration was adopted, shows any of the following:
 - (A) The project will have one or more effects that are significant effects not discussed in the previous EIR or negative declaration;
 - (B) Significant effects previously examined will be substantially more severe than shown in the previous EIR;
 - (C) Mitigation measures or alternatives previously found not to be feasible would in fact be feasible, and would substantially reduce one or more significant effects of the project, but the project proponents decline to adopt the mitigation measure or alternative; or
 - (D) Mitigation measures or alternatives which are considerably different from those analyzed in the previous EIR would substantially reduce one or more significant effects on the environment, but the project proponents decline to adopt the mitigation measure or alternative.

CHAPTER 2: PROJECT DESCRIPTION

2.1 Background

The Project is within the boundaries of the North Santa Rosa Station Area Specific Plan and Specific Plan EIR. Said plan has been incorporated into the General Plan and is considered consistent forthwith. The Project is within the City of Santa Rosa designated Opportunity Area, which is part of the City of Santa Rosa Resilient City Development Measures. Being within a designated Opportunity Area allows the application of density bonus measures and streamlines the entitlement process. Accordingly, the Project has accessed a City density bonus of 65% and a State density bonus of 35%. The city and the State density bonus measures have been found consistent with the General Plan.

A Neighborhood Meeting for the Project was held on January 15, 2020.

The Project underwent Concept Design Review on March 5, 2020.

2.2 Project Setting

2.2.1: Location:

The project site is located at 1650 West Steele Lane in the Northwest quadrant of Santa Rosa. The site is situated at the southeast corner of West Steele Lane and Meadowbrook Court. The site is within 1/2-mile of the Sonoma-Marín Area Rail Transit (SMART) Guerneville Road rail stop and a major regional shopping center (Coddington Mall). The site is accessible from both West Steele Lane and Meadowbrook Court. The site is identified as Assessor Parcel No. (APN) 041-042-012.

2.2.2: Topography and Natural Features:

The site is generally level, sloping down from the southeast corner to the northwest corner at $\pm 1/8''$ per foot. Vegetation consist of annual grasses, clusters of mature trees and herbaceous plant material.

2.2.3: Surrounding Land and Land Uses

Surrounding land uses consist of Snoopy Ice Arena, the Schulz Museum and the Children's Museum to the north and urban density residential to the east, south and west.

2.3 Existing Physical Conditions

As depicted below, the site is undeveloped. A property line fence exists along the east and south property lines, a 6" concrete curb runs the length of the west property line and street improvements consisting of sidewalk, curb, gutter, pedestrian ramp and a concrete driveway cut forms the north property line.



Figure 1: Project Site – Existing Conditions

2.4 Project Description – Detail

The subject parcel is a ±0.98-acre urban in-fill property, designated in the Santa Rosa North Station Area Specific Plan and General Plan as Medium Density Residential. According to the standards set forth in Section 20-22.020 C. of the city's Zoning Code, the purpose of the R-2 (Medium Density Multi-Family Residential) is to provide home rental and ownership opportunities, and to provide a full range of choices in housing types to improve access to affordable housing.

The Project proposes 36 apartment units within three buildings, and a two-level automated parking structure, four units will be affordable through deed restrictions. The Project includes a 35% State Density Bonus and a 65% City of Santa Rosa Density Bonus. Multi-family residential development is permitted by right in the Medium Density Residential District. Per the City's Resilient City Development Measures and the City's Density Bonus Ordinance the Project is required to obtain Minor Design Review for the residential units and a Minor Conditional Use Permit for the Supplemental Density Bonus application. Each hearing will be held before the Zoning Administrator.

2.4.1: Residential Apartments

The project proposes 36 apartment units spread amongst three, three-story buildings. Thirty-two (32) of the units are market-rate. Of these units, two (2) are one-bedroom; 27 are two-bedroom and three (3) are three-bedroom. There are four (4) Affordable Units. Of these four units are two (2) are one-bedroom units and two (2) are two-bedroom units. All of the Affordable Units are reserved for Very-Low Income Households. The buildings are arranged along the lengths of the parcel and punctuated by an open plaza at the intersection of Meadowbrook Court and West Steele Lane, which leads to an internal plaza with a fountain. Access is from Meadowbrook Court along a 26 ft. wide private drive. 36 vehicle parking spaces and 18 bicycle spaces are provided. Of the 36 parking spaces, 25 spaces are provided by a covered stacked parking structure along the eastern property line, 6 are within garages and 5 are open spaces along the southern property line. The buildings have a maximum height of 37 ft. 9 inches. The parking structure is approximately 13 ft. in height. The exterior finish of the buildings will be stucco in a sea pearl with synthetic slate roofs in a Federal gray. The buildings will be accented with vertical tile and metal balconies.

2.4.2: Community Amenities Area

Community Amenities Area is reserved for use by residents only. The area includes an entry plaza with a seat wall and arbor, lobby, laundry room, office and internal open space plaza with a fountain.

2.4.3: Landscaping

A series of trees and low planting line the property boundaries. Vines cover the vertical trellis along the length of the parking structure. The entry plaza includes a feature tree in the center of the plaza as well as a seat wall with and arbor. The central plaza is lined with trees and shrubbery. The project landscape design will comply with the latest Water Efficient Landscape Ordinance (WELO) (A.B. 1881) by utilizing a high-efficiency, low flow-type, sub-surface irrigation system with smart controller, flow, and rain sensing equipment.

2.4.5: Special Features Incorporated into the Project

Energy Efficiency: The buildings have been designed to be all electric per the City's Reach Code and is fully compliant with the city of Santa Rosa Climate Action Plan (see Section 2.5 below).

Noise Attenuation: A Noise Impact Analysis Report was prepared for the project by First Carbon Solutions, dated July 2, 2020. The report found that with the implementation of current building code construction standards regarding walls, windows and doors and the inclusion of air conditioning for the units, will result in a noise impact that is considered Less Than Significant.

2.5. Green Technologies and Santa Rosa Climate Action Plan Compliance (SRCAP)

2.5.1 Green Technologies

The green technologies and design components to be integrated into the Project are summarized below.

- Durability- Building cladding is stucco, a material which adds value to project, and is more durable than siding. Stucco is also fire proof and adds building mass for increased energy efficiency / better R value.
- Reparability – Stucco is impact resistant and relatively simple to repair.
- Low toxicity – Interiors will be formaldehyde free and low VOC. No vinyl components are proposed for flooring, windows or doors. Plastics, when used, are recycled and do not contain phthalates.
- Recycled content – Recycled asphalt, cement, and concrete are specified for hardscape paving, masonry walls, and foundation backfill.
- Regionally sourced – Landscape materials, including plants, mulches, soils, and ornamental features will be locally sourced
- Ability to be recycled or reused – The primary building components are concrete foundation, wood framing, asphalt driveway, gypsum interior fireproofing, concrete masonry site and parking structure walls, steel framing, steel railings, porcelain tile and fixtures, which are all made from materials that can be recycled without contributing to the landfill or releasing toxic chemicals into the environment as they break down or if they are burned in a fire
- Ease of maintenance – Stucco building cladding, anodized bronze railings, concrete masonry and cement site walls, engineered wood joists and trusses, recycled concrete hardscape and parking structure walls, fiberglass windows and doors, porcelain and ceramic tiles, and high albedo composition roof shingles are all lifetime structural components and finish materials, projected to last over 50 years. Adhesives, sealants, appliances, fixtures, heating / cooling equipment, plumbing, and electrical components specified for energy and water efficiency as well as for low maintenance and lifespans of at least 8 to 10 years, as well as conformance with mandatory items in the State of California’s Residential CALGreen Tier 1 Checklist.
- Sustainable materials – Synthetic Roof Underlayment
The underlayment on roofs is typically asphalt-based, which breaks down relatively quickly. Synthetic roof underlayment offers an alternative that weighs less and holds

up to the wear and tear of an exterior environment. This material uses polymer that comes from recycled scrap materials. It also eliminates VOCs from the underlayment.

- Fully automated parking – Autonomous shuttles can fit cars into the right-sized spot, optimizing what would otherwise be wasted space. The elimination of ramps and pedestrian walkways further reduces the volume. Reducing parking volume by 30% to 50% frees up space for housing. Users of an automated parking system drop their car in a bay and leave. A mobile app enables users to call their car and control the entire parking process.
- Courtyard Archetype – The courtyard acts as an extension of the surrounding urban public space and an extension of the semi-private open spaces at individual unit patios and terraces. It extends the space of unit interiors, giving a sequence of open space (courtyard) and enclosed space (rooms). The courtyard helps to reduce circulation space and maximize living space within the house.
- Conforms with Santa Rosa All Electric Reach Code – Eliminates combustion of natural gas in livable areas, improves indoor air quality and improves overall safety associated with fires and gas leaks. Use of electric heating, electric heat pump appliances (such as water heaters, air conditioning and heaters) and on-site solar generation, required in the 2019 Building Code.

The Project will also incorporate Low Impact Development (LID) measures as called for in the City of Santa Rosa's Standard Urban Stormwater Management Plan (SUSMP). The City's SUSMP prioritizes the use of LID and the capture of small storm volume for infiltration on-site.

2.5.2 Climate Action Plan

The Project incorporates the following policy measures contained the Santa Rosa Climate Action Plan. Required measures are indicated by an “*”:

*Policy 1.1.1 - Comply with CAL Green Tier 1 Standards: The Project is designed to comply with State Energy requirements for Title 24, City of Santa Rosa's Cal Green requirements and any mandatory CAL Green Tier 1 Standards in effect at time of permit submission. To the extent required, such standards have been incorporated into building placement, site development, building design and landscaping.

*Policy 1.1.3 – After 2020, all new development will utilize zero net electricity: The Project is all electric per the City's Reach Code but is not net zero.

*Policy 1.3.1 – Real time Energy Monitors: The Project will include energy monitors to track energy use for all common areas as well as smart meters for individual units.

*Policy 1.4.2 - Comply with the City's Tree Preservation Program: The project will mitigate for the removal of all protected trees in accordance with the city's Tree Ordinance. The landscape plan calls for the planting of fourteen (14) trees as well as numerous shrubs and vines throughout the site.

*Policy 1.4.3 – Provide public and private trees in compliance with the Zoning Code: New trees and plantings associated with development are shown on the Landscape Plan prepared by Mac Nair, landscape architect and will be installed in accordance with the requirements of the Santa Rosa Zoning Code and the Santa Rosa Design Review Landscape Standards for planting private and public trees.

Policy 1.5 – Install new sidewalks and paving with high solar reflectivity materials: All proposed new sidewalks, driveways and parking areas will be paved with materials that contain either color or other enhancements to provide enhanced reflectivity.

Policy 2.1.3 – Pre-wire and pre-plumb for solar thermal or PV systems: The Project is in compliance with said policy.

Policy 3.1.2 - Supports implementation of station plans and corridor plans: The Project is consistent with the North Santa Rosa Station Area Specific Plan (Specific Plan), by proposing the construction of higher densities development within walking distance of SMART service.

Policy 3.2.1 – Provide on-site services such as ATMs or dry cleaning to site users: On-site laundry facilities will be provided. ATMs and dry-cleaning facilities are not applicable.

Policy 3.2.2 – Improve non-vehicular network to promote walking and biking: The Project will include sidewalks on West Steele Lane and Meadowbrook Court street frontages and Class II bike lanes on West Steele Lane. Bicycle parking is provided adjacent to the entry plaza.

Policy 3.2.3 - Support mixed use, higher density development near services: The Project is consistent with North Santa Rosa Station Area Specific Plan (Specific Plan), developed to require higher densities within walking distance of SMART service.

Policy 3.3.1 - Provide affordable housing near transit: The Project will provide affordable housing within 1/2 mile of the SMART North Santa Rosa Station and is located in close proximity to a bus stop on West Steele Lane serviced by Santa Rosa CityBus.

Policy 3.5.1 – Unbundle parking from property cost: The parking is unbundles from the units.

Policy 4.1.1 - Implement the Bicycle & Pedestrian Master Plan: Class II bike lanes exist on West Steele Lane.

*Policy 4.1.2 – Install bicycle parking consistent with regulations: The Project will provide nine secure, on-site covered bicycle storage spaces and nine bicycle parking spaces.

*Policy 6.1.3 – Increase diversion of construction waste: The contractor will divert all possible construction waste and prepare a Construction Waste Management Plan for recycling and disposal of construction wastes.

*Policy 7.1.1 – Reduce potable water for outdoor landscaping: As shown on the plan, Project landscaping will utilize low water use native plants. Landscape irrigation complies with the City’s Water Efficient Landscape Ordinance (WELo).

*Policy 7.1.3 – Install Real time water meters: City standards only allows one public water meter per development for developments of less than 100 units. The single City meter will not track real time water use; however, the project will install sub-meters on all units and spaces utilizing domestic water.

*Policy 7.3.2 – Meet on-site meter separation requirements in locations with current or future recycled water capabilities: There are no currently available City urban reuse water mains in the project vicinity.

Policy 9.1.2 – Provide outdoor electrical outlets for charging lawn equipment: Electrical outlets have been so provided.

*Policy 9.1.3 – Install low water use landscapes: Low water use plants will be used to landscape the site. Plant materials and locations are shown on the Project landscape plans.

*Policy 9.2.1 – Minimize construction equipment idling time to 5 minutes or less: The developer will condition contractor agreements to limit construction equipment idling time to 5 minutes or less, consistent with the City’s Standard Measures for Air Quality.

*Policy 9.2.2 – Maintain construction equipment per manufacturer’s specifications: The developer will condition contractor agreements to require all equipment used at the site to be maintained in accordance with the manufacturer’s instructions.

*Policy 9.2.3 – Limit Green House Gas (GHG) construction equipment by using electrified equipment or alternate fuel: The developer will include provisions in contractor agreements encouraging the use of electrified equipment or equipment using alternative fuels.

2.6 Project Duration

Construction

Construction would take approximately 18 months, including on-site grading. Construction would be anticipated to begin in Spring/Summer of 2023 and completed during Fall/Winter of 2024. Site development would be limited to the hours of 7:00 AM to 7:00 PM, Monday-Friday and 8:00 AM to 6:00 PM on Saturdays or as allowed by the City’s Municipal Code Section 17-16.030.

2.7 Other Required Agency Approvals

The Project requires Minor Design Review approval from the Zoning Administrator of the City of Santa Rosa and approval of a Supplemental Density Bonus via a Minor Conditional Use Permit. Parking and setback concessions are being requested as part of the density bonus. No Regional, State or Federal Agency approvals are required.

CHAPTER 3: ANALYSIS

This Addendum analyzes those sections of the previously adopted Environmental Impact Report that could potentially be affected by the development of an additional 18 apartment units, four of which will be affordable, and the associated parking. This represents the delta between the project anticipated by the NSRSASP EIR and the proposed project. The density of the proposed project is 100% above that which is identified in the NSRSASP. This density was achieved through the exercising of a 35% State Density Bonus and a 65% City of Santa Rosa Density Bonus. The Addendum specifically evaluates whether the addition of the 18 units and action by the City to approve the Minor Conditional Use Permit and Density Bonus applications would trigger the need for the preparation of a subsequent Negative Declaration under CEQA Guidelines sections 15164, subdivision (b) and 15162, subdivision (a).

This Addendum relies on the Final EIR adopted for the North Santa Rosa Station Area Specific Plan. The North Santa Rosa Station Area Specific Plan Environmental Impact Report (Specific Plan EIR, State Clearinghouse Number 2011122034) was certified by the City Council on September 18, 2012.

Both the Specific Plan and EIR are available at:
City of Santa Rosa Department of Planning and Economic Development
City Hall 100 Santa Rosa Avenue, Room 3
Santa Rosa, CA or on the City's web page: srcity.org.

3.1 Addendum Criteria: Substantial change in the project, circumstances or new information

According to CEQA Guidelines Section 15164, if none of the conditions described in CEQA Section 15162 calling for the preparation of a subsequent EIR or negative declaration have occurred, then an addendum to an adopted EIR or Negative Declaration can be prepared (CEQA Section 15164 (b)). As identified in the above referenced section entitled "CEQA Standard", CEQA Section 15162 sets forth three conditions, any one of which would cause the preparation of a subsequent EIR or subsequent Negative Declaration.

They are:

1. Substantial changes in the project which would result in new significant effects or an increase in the severity of previously identified significant effect.
2. Substantial changes in circumstances under which the project is undertaken that would result in new significant effects or an increase in the severity of previously identified significant effect.
3. New information of substantial importance, which was not known or could be known, that shows:
 - a) The project will have one of more significant effect not discussed in the previous Negative Declaration.

- b) Significant effects, previously examined, will be more severe than shown.
- c) Mitigation measures previously considered not to be feasible are feasible and would reduce one or more significant effects of the project, but the project proponents decline to adopt the mitigation measures or alternatives.
- d) Mitigation measures or alternatives that are considerably different than those analyzed in the previous EIR that would substantially reduce one or more significant effects on the environment, but the project proponent declined to adopt the mitigation measure or alternative.

3.2 Assessment of Degree of Change or New Information

The analysis will begin by assessing the degree of possible change to each category as a result of the proposed Project. (Categories are listed in the order they appear in a standard Environmental Checklist: Appendix G)).

TABLE 1: Impact Analysis – Proposed Project compared to North Santa Rosa Station Area Specific Plan Final EIR (NSRSASP EIR)		
Impact Category	Additional Analysis Required	Discussion
1. AESTHETICS	Yes	The addition of 18 additional units and associated parking is a change that may cause a substantial aesthetic effect or result in inconsistency with the NSRSASP. Further analysis is warranted.
2. AGRICULTURAL RESOURCES	No	The project site is within the city limits of the city of Santa Rosa, has not been identified as farmland of statewide importance, is not under Williamson Act contract and is less than one acre,

		which would not be suitable for farming.
3. AIR QUALITY	Yes	The addition of 18 additional units and associated parking is a change that may cause a substantial air quality effect. The project will be analyzed in relation to the applicable Thresholds of Significance established in the BAAQMD May 2017 CEQA Guidelines.
4. BIOLOGICAL RESOURCES	Yes	Site coverage resulting from the addition of 18 additional units and associated parking is a change that may cause a substantial biological effect through the removal of or impact on existing vegetation. Further analysis is warranted.
5. CULTURAL RESOURCES	No	The change in the project through the addition of 18 units would not alter the adopted determinations and mitigations under the Cultural Resources section of the NSRSASP EIR. Said adopted determinations and mitigations are considered accurate, applicable and sufficient

		as regards to the proposed Project. A Cultural Resources Study was prepared by Tom Origer & Associates. July 2020. No significant resources were found and no mitigations were required. The study is included in Appendix A. No further analysis is necessary.
6. GEOLOGY AND SOILS	Yes	Site coverage resulting from the addition of 18 additional units and associated parking is a change that may cause a substantial geological effect. Further analysis is warranted.
7. GREENHOUSE GAS EMISSIONS	Yes	The addition of 18 additional units and associated parking is a change that may cause a substantial GHG impact. Further analysis relative to the city of Santa Rosa adopted Climate Action Plan is warranted.
8. HAZARDOUS AND HAZARDOUS MATERIALS	No	The adopted determinations and mitigations under the Hazards and Hazardous Materials section of the NSRSASP EIR are accurate, applicable and sufficient as regards to the proposed Project.

		<p>Further analysis is not required. The addition of 18 additional units would not cause a change to a potential Hazardous and hazardous materials impact.</p>
<p>9. HYDROLOGY AND WATER QUALITY</p>	<p>Yes</p>	<p>The addition of 18 additional units and associated parking is a change that may cause a substantial hydrological/water quality impact. Further analysis is warranted.</p>
<p>10. LAND USE AND PLANNING</p>	<p>No</p>	<p>36 units represents the addition of 18 units over the maximum density considered in the land use designation of the NSRSASP. The density increase is supported by adopted policies in the City of Santa Rosa General Plan and State and local Density Bonus regulations, as well as the City of Santa Rosa adopted Resiliency Measures. Furthermore, the 18 additional units are integrated into a single, well-designed project thereby negating the possibility of physically dividing an establish community; a habitat conservation plan does not exist for the</p>

		area; and, the additional units are within the incorporated city and will have no impact on the City’s Urban Growth Boundaries. No further analysis is warranted.
11. MINERAL RESOURCES	No	The adopted determinations and mitigations under the Mineral Resources section of the NSRSASP EIR are accurate, applicable and sufficient as regards the proposed Project. No further analysis is necessary.
12. NOISE	Yes	The addition of 18 units represents a change in the project and could result in a significant noise impact. Further analysis is warranted.
13. POPULATION AND HOUSING	No	Although the addition of 18 units is above the maximum density allowed by the land use designation in the NSRSASP, the additional units are supported by adopted General Plan policies, City of Santa Rosa Density Bonus policies and State Density Bonus policies. No further analysis is required as

		regards Population and Housing.
14. PUBLIC SERVICES	No	18 additional units represents a 0.11% increase in the total number of theoretical units anticipated by the NSRSASP at full buildout. 18 additional units integrated into a single well-designed project, which represents a 0.025% population increase, will not cause a potential significant impact to the SRFD who provides fire protection and medical emergency service to an existing population of 176,759 persons or the SRPD who provides law enforcement service to the same population. The application of MM 3.12.1 of the NSRSASP EIR to the entire project (additional 18 units) would reduce the potential impact of the unit increase to Less Than Significant. No further analysis is required.
15. RECREATION	No	Although the Project includes the addition of 18 units above the maximum density allowed by the land use

		<p>designation in the NSRSASP, the additional units are supported by adopted General Plan policies, City of Santa Rosa Density Bonus policies and State Density Bonus policies. The payment of Park Impact Fees related to the number of proposed units is a standard COA and will off-set the potential impact to Recreation. No further analysis is required.</p>
<p>16. TRANSPORTATION/ TRAFFIC</p>	<p>Yes</p>	<p>In July 2020, legislation requiring potential traffic impacts to be analyzed on the basis of vehicle miles traveled (VMT) instead of level of service (LOS) was implemented by Cal-Trans. This represents New Information and the potential impact will require further analysis.</p>
<p>17. TRIBAL CULTURAL RESOURCES</p>	<p>No</p>	<p>Early consultation with tribal communities is required per AB 52. Although this represents new information the consultation will be performed by the City of Santa Rosa. Any recommended measures, if required, would be the</p>

		<p>same regardless of the additional 18 units. Said measures would be incorporated into standard COA. No further analysis is required.</p>
<p>18. UTILITIES AND SERVICE SYSTEMS</p>	<p>No</p>	<p>As discussed above, the addition of 18 additional units over and above that which the NSRSASP EIR analyzed represents a 0.11% increase in number of total units analyzed. Furthermore, these additional units are supported by housing policies in the General Plan. The additional units are supported by and made possible through the implementation of the adopted City of Santa Rosa Density Bonus Ordinance. The MND for said ordinance found a Less Than Significant Impact as regards Utilities and Service System. Other than in the area of Public Safety Services (discussed above) all potential impact areas related to Utilities and Service Systems were found to be Less Than Significant in the NSRSASP EIR.</p>

		No further analysis is warranted.
19. MANDATORY FINDINGS OF SIGNIFICANCE	No	No, only if analysis determines no significant impacts.

3.3. Level of Significance

The impact categories identified in the above analysis, which require additional review to determine their potential level of significance are discussed below in the order they appear in Table 3, above. (Numbering relates to the specific impact category.)

1. AESTHETICS: The Project has been analyzed against the Design Goals and Guidelines of the NSRSASP as shown in Table 2 and 3, below:

Table 2: NSRSASP Design Goals	
Design Goals	Project Consistency
To create an active, vibrant, and distinct place where people want to live, work, and visit.	The open plaza which includes a seat wall and an arbor is open to both West Steele Lane and Meadowbrook Court. This feature with its center canopy tree as well as the window and balcony detail help create an active, vibrant street presence.
To ensure that building designs, site layout, and building uses support a transit-friendly environment.	The higher density multi-family residential use places a greater number of persons in close proximity to the North Santa Rosa SMART station.
To beautify the existing streetscapes and maximize the visual and physical connections within the area.	The buildings are articulated to provide street interest. The landscape design provides walled patios, a raised entry plaza and covered passage into a private courtyard. Street trees, shrubbery and ground cover are introduced along West Steele Lane and Meadowbrook Court.
To encourage buildings with active and open facades that interest those walking and biking in the area, and to create an active pedestrian-oriented streetscape.	The raised entry plaza with center landscaping and seat wall as well as the well- articulated buildings with tiled treatment and balconies provide an active pedestrian-oriented streetscape.
To incorporate sustainable building principles into all new development.	Buildings are designed to provide cross-thru ventilation and maximize access to natural light for all units. Storm water runoff is detained and retained by

	maximizing the use of pervious surfaces, and vegetated bio-swales.
To create and define welcoming, safe open space for all to enjoy.	The project has a series of community and private open space features through the provision of the seat-wall, court yard and private patios and balconies.
To create multi-story buildings that provide a human scale.	The project is three-story and well-articulated.
To encourage superior design with well-crafted and detailed building facades, particularly at the street level.	The project has detailed facades. Not less than 60% of the building façade is oriented parallel to the streets.
To create a comfortable environment for pedestrians, bicyclists, and vehicles alike.	The shaded seat-wall allows for gathering. This community patio has been designed to include bicycle racks.
To design sites so that the vehicle is not the dominant feature.	All parking is to the rear portion of the site and the majority is located within a parking structure or garage.

Table 3 Design Guidelines		
NSRSASP Design Guidelines		Project Consistency
Building Placement	<ul style="list-style-type: none"> • Encourage buildings to be built to the minimum setback assigned for the district. • No less than 60% of the building façade should be oriented parallel to the street on which it fronts. • Arrange buildings to define, connect, and activate sidewalks and public spaces. 	<p>The buildings are designed to be built at minimum setback.</p> <p>Not less than 60% of the building façade is oriented toward the streets fronting the project site.</p> <p>The project has been so arranged.</p>
Landscaping	<ul style="list-style-type: none"> • Landscaping should be native and drought-tolerant species to the greatest extent possible. • Landscaping should be properly maintained and trimmed to maximize visibility. 	<p>Drought tolerant plants have been used.</p> <p>The landscaping will be maintained by the management company.</p>

	<ul style="list-style-type: none"> • Development shall provide up to 10–30% of the total project area for landscaping and open space amenities such as patios, courtyards, or rooftop gardens. 	<p>45% of the site at ground level is landscaped or dedicated to pedestrian and common or semi-private open space.</p>
<p>Parking</p>	<ul style="list-style-type: none"> • Private alleys are encouraged to provide access for service and parking. • All parking areas should be well lit with clearly identified exits and connections to streets and sidewalks. • Parking areas should be screened from public streets to minimize visibility from the public right-of-way. 	<p>The site size and configuration does not lend itself to the use of alleys. However, the parking is located to the rear of the property. The lighting plan will provide adequate security lighting without impacting the neighboring residential uses.</p> <p>The parking is screened from West Steele Lane and Meadowbrook Court to the extent feasible.</p>
<p>Sustainable Site Design</p>	<ul style="list-style-type: none"> • Buildings should be oriented to maximize passive solar heating during cool seasons, avoid solar heat gain during hot periods, and maximize natural ventilation. • Stormwater runoff should be detained and retained by maximizing the use of pervious surfaces, vegetated bio-swales, and vegetative ground cover to the 	<p>Buildings are designed to provide cross-thru ventilation and maximize access to natural light for all units.</p> <p>The project’s storm water retention plan has detained and retained water on-site through the use of vegetated bio-swales and ground cover.</p>

	<p>greatest extent practicable.</p> <ul style="list-style-type: none"> • The use of recycled water for landscaping is encouraged. 	<p>This is not proposed.</p>
<p>Sustainable Site Materials</p>	<ul style="list-style-type: none"> • Site materials should be selected based on the following characteristics, to the greatest extent practicable: <ul style="list-style-type: none"> • Durability • Reparability • Low toxicity • Recycled content • Regionally sourced • Ability to be recycled or reused • Ease of maintenance 	<p><u>Durability:</u> The building cladding is stucco, which is durable, fire proof and adds building mass for increased energy efficiency.</p> <p><u>Reparability:</u> Stucco is impact resistant and relatively simple to repair. The synthetic slate roofing shingles are relatively inexpensive to repair.</p> <p><u>Low Toxicity:</u> Interior materials will be formaldehyde free and low VOC. No vinyl components are proposed for the flooring, windows or doors.</p> <p><u>Recycled Content:</u> Recycled asphalt, cement, and concrete are specified for hardscape paving, masonry walls, and foundation backfill. Recycled synthetic slate shingle roofing is specified for roofing.</p> <p><u>Regionally Sourced:</u> Landscape materials, including plants, mulches, soils, and ornamental features will be locally sourced.</p>

		<p><u>Ability to be Recycled or Reused:</u> The primary building components are concrete foundation, wood framing, asphalt driveway, gypsum interior fireproofing, concrete masonry site and parking structure walls, steel framing, steel railings, porcelain tile and fixtures. These components are all made from materials that can be recycled without contributing to the landfill or releasing toxic chemicals into the environment as they break down or if they are burned in a fire.</p> <p><u>Ease of Maintenance:</u> Stucco building cladding, anodized bronze railings, concrete masonry and cement site walls, engineered wood joists and trusses, recycled concrete hardscape and parking structure walls, fiberglass windows and doors, porcelain and ceramic tiles, and high albedo synthetic slate roof are all lifetime structural components and finish materials, projected to last over 50 years. Adhesives, sealants, appliances, fixtures, heating / cooling equipment, plumbing, and electrical components specified for energy and water efficiency as well as for low maintenance and lifespans of at least 8 to 10</p>
--	--	-----------------------------------------------------------------------------------------------------------------------------------------------------------------------------------------------------------------------------------------------------------------------------------------------------------------------------------------------------------------------------------------------------------------------------------------------------------------------------------------------------------------------------------------------------------------------------------------------------------------------------------------------------------------------------------------------------------------------------------------------------------------------------------------------------------------------------------------------------------------------------------------------------------------------------------------------------------------------------------------------------------------------------------------------------------------------------------------------------------------------------------------------------

		<p>years, as well as conformance with mandatory items in the State of California’s Residential CALGreen Tier 1 Checklist.</p>
<p>Compatible Design</p>	<ul style="list-style-type: none"> • Development on either side of streets (facing each other) should be designed at a compatible scale and massing to encourage a comfortable pedestrian environment and maintain a sense of visual cohesion along the street. 	<p>Snoopy Ice Area is across West Steele Lane from the project. The ice arena is set back a considerable distance from West Steele Lane and parking is provided to the east of the building. Although designated as Medium Density Residential, one small parcel across Meadowbrook Court from the site’s western property line is developed with a single-story, single-family residence. The project would be setback approximately 53.5 ft. from the adjoining property line. Street trees, ground cover and shrubbery will be planted along the project’s Meadowbrook Court property line. Given the design of the project and the distance from the surrounding uses, the project is considered compatible.</p>
<p>Articulation</p>	<ul style="list-style-type: none"> • Architectural scaling elements should be used to break down the appearance of large building facades into architectural patterns and component building forms. 	<p>This is reflected in the building design. Buildings are articulated and rooflines of single buildings are broken up into multiple planes.</p>

	<ul style="list-style-type: none"> • The use of color and a variety of materials, projections, awnings, and canopies should be used to achieve variation and articulation in the building facade. • Blank walls should be avoided, and largescale HVAC ventilation ducts facing sidewalks or primary streets are discouraged. • Facades greater than 100 feet in length should incorporate recesses and projections a minimum of 3 feet in depth and a minimum of 20 contiguous feet within each 100 feet of facade length. Windows, awnings, balconies, entry areas, and arcades should total at least 60% of the facade length facing a public street. 	<p>Window placement, balconies, use of exterior tile and building articulation address this issue.</p> <p>There are no large blank walls and the HVAC ventilation ducts do not face the sidewalks or street.</p> <p>The building design reflects these recommendations.</p>
<p>Multi-Building Complex</p>	<ul style="list-style-type: none"> • All buildings within a multi-building complex should achieve a unity of design through the use of similar architectural elements, such as roof form, exterior building materials, colors, and window pattern. 	<p>All buildings are of the same architectural design with the same roof forms, window patterns, color, materials and balconies.</p>

	<p>Individual buildings should incorporate similar design elements, such as surface materials, color, roof treatment, windows, and doors, on all sides of the building to achieve a unity of design.</p>	
Building Frontage	<ul style="list-style-type: none"> The following frontage types are encouraged in residential areas: Forecourt, Light Court, Dooryard/Terrace Porch, Stoop. 	<p>The entry to the building is through a community patio, which leads to a central plaza. This forms a courtyard from which access to the buildings are taken.</p>
Roof Forms	<ul style="list-style-type: none"> A variety of roof forms is encouraged. Roof types that are larger, simpler, visually quiet, and formally cohesive are preferred. Roof forms such as parapets, gable end, mansard, dormers, shed, hip, and barrel vaults are encouraged. Preferred roof materials are ballasted flat roofs, metal standing seam, concrete or terra cotta tile, and composite shingles. 	<p>The roof form is a simple shed roof which is broken up through the articulation of the building.</p> <p>The roof material is a synthetic slate.</p>
Materials	<ul style="list-style-type: none"> All building materials should be selected with the objectives of quality and durability as well as to produce a positive 	<p>This has been done. See discussion on Sustainable Site Materials. Furthermore, the open plaza which includes a concrete seat wall and an</p>

	<p>effect on the pedestrian environment through scale, color, and texture.</p> <ul style="list-style-type: none"> Architectural metals, cast-in-place concrete, brick, concrete masonry units, tile, glass, and glass block systems, among others, are acceptable materials when properly finished and detailed. 	<p>arbor is open to both West Steele Lane and Meadowbrook Court. This feature with its center canopy tree as well as the window, tile and balcony detail help create an active, vibrant street presence.</p>
<p>Green Building Materials</p>	<ul style="list-style-type: none"> Building materials should be evaluated and selected based on the following characteristics: <ul style="list-style-type: none"> Durability Reparability Low toxicity Recycled content Locally sourced Ability to be recycled or reused Ease of maintenance 	<p>See response under Sustainable Site Materials</p>
<p>Green Building Design</p>	<p>The following guidelines should be considered to help implement the Cal-Green tier one Building Code:</p> <ul style="list-style-type: none"> Project designs that incorporate renewable energy sources, such as integrated solar panels, are encouraged. 	<p>The project does not include solar. However, the buildings are designed to provide cross-thru ventilation and maximize access to natural light for all units. Additionally, the stucco exterior adds building mass for</p>

	<ul style="list-style-type: none"> • Light-colored materials, high-albedo roofs, green roofs, windows, external shading, and larger eaves are encouraged to naturally control heat gain and heat loss in buildings. 	<p>increased energy efficiency.</p>
<p>Walls and Fences</p>	<ul style="list-style-type: none"> • Fences and walls should be made of durable materials. Preferred materials for walls are brick, concrete masonry units, pour-in-place concrete, tile, or stucco. Preferred materials for fencing are steel mesh, wrought iron, or treated wood. • Walls and fences that face onto a street, park, or public area should be designed to have a 4-foot-wide landscape planting area. 	<p>Project fencing is metal concrete masonry and cement walls.</p> <p>The concrete masonry patio walls are setback greater than 4ft. behind the tree-lined planter strip.</p>
<p>Screening of Mechanical Equipment and Service Areas</p>	<ul style="list-style-type: none"> • All rooftop building systems should be incorporated into the building form in a manner integral to the building architecture. All rooftop-mounted mechanical, electrical, and telecommunication systems shall be screened from view of 	<p>Said systems are screened from view.</p>

	<p>surrounding streets and structures.</p> <ul style="list-style-type: none"> • Refuse storage and pickup areas should be combined with other service and loading areas and screened from view from public streets whenever possible. 	<p>The trash enclosure is located at the rear of the property and would not be visible from the street.</p>
--	------------------------------------------------------------------------------------------------------------------------------------------------------------------------------------------------------------------------------------------------------	-------------------------------------------------------------------------------------------------------------

As shown from the above analysis, the Project, which includes the additional 18 units is consistent with all of the Design Goals and Guidelines of the NSRSASP. However, because of the additional 18 units, criterion #1 of CEQA Guideline Section 15162, that is, substantial change to the project might have caused to new significant effects or more significant effects as regards AESTHETICS. Given the consistency with the NSRSASP Design Goals and Guidelines there was no new or more significant AESTHETIC effect. This being the case, a subsequent or new Negative Declaration or mitigated Negative Declaration is not required. The proposed Project qualifies for an Addendum.

3. AIR QUALITY

An Air Quality Assessment using the BAAQMD 2017 CEQA Air Quality Guidelines, was prepared for the project by Illingworth & Rodkin. June 4, 2020. The project is considered a Low- Rise Apartment approximately 48,005 sq. ft. in size with 880 sq. ft. of surface parking and 5,225 sq. ft. of enclosed parking. As shown below, the report found the project to be significantly below the daily emissions thresholds for both construction and operations.

Table 3. Construction Period Emissions

Scenario	ROG	NOx	PM ₁₀ Exhaust	PM _{2.5} Exhaust
Annual Total Construction Emissions (tons)	1.0	2.2	0.12	0.11
Average Daily Emissions (pounds/day)¹	7.7	16.7	0.9	0.8
<i>BAAQMD Thresholds (pounds per day)</i>	<i>54 lbs./day</i>	<i>54 lbs./day</i>	<i>82 lbs./day</i>	<i>54 lbs./day</i>
Exceed Threshold?	<i>No</i>	<i>No</i>	<i>No</i>	<i>No</i>

¹Assumes 269 workdays.

Table 4. Operational Period Emissions

Scenario	ROG	NOx	PM ₁₀	PM _{2.5}
2023 Project Operational Emissions (<i>tons/year</i>)	0.45 tons	0.31 tons	0.29 tons	0.08 tons
<i>BAAQMD Thresholds (tons /year)</i>	<i>10 tons</i>	<i>10 tons</i>	<i>15 tons</i>	<i>10 tons</i>
<i>Exceed Threshold?</i>	<i>No</i>	<i>No</i>	<i>No</i>	<i>No</i>
2023 Project Operational Emissions (<i>pounds/day</i>) ¹	2.5 lbs.	1.7 lbs.	1.6 lbs.	0.5 lbs.
<i>BAAQMD Thresholds (pounds/day)</i>	<i>54 lbs.</i>	<i>54 lbs.</i>	<i>82 lbs.</i>	<i>54 lbs.</i>
<i>Exceed Threshold?</i>	<i>No</i>	<i>No</i>	<i>No</i>	<i>No</i>

Note: ¹ Assumes 365-day operation.

The report did recommend a Mitigation Measure to control dust and exhaust during construction. This mitigation measure is consistent with that found in the EIR for the NSRSASP, represents Best Management Practices and can be implemented through a standard condition of approval (COA).

Because the project includes 18 units over and above the maximum number of units identified in the land use element of the NSRSASP, criterion #1 of CEQA Guideline Section 15162, that is, substantial change to the project might have caused to new significant effects or more significant effects could have been engendered as regards AIR QUALITY. The Air Quality Assessment showed the Project to be below BAAQMD 2017 CEQA Air Quality Guidelines levels of significance. The recommended mitigation is standard Best Management Practices and can be implemented through a standard COA. This being the case, a subsequent or new Negative Declaration or mitigated Negative Declaration is not required. The proposed Project qualifies for an Addendum.

6. GEOLOGY AND SOILS

The NSRSASP EIR found build-out of the Specific Plan area to have a Less Than Significant and Less Than Cumulatively Considerable Geologic/Soils impact. This determination was based on the understanding that all applicable regulatory requirements such as, but not limited to, adherence to the State and Local Building Code and preparation of a soils report at time of building permit would be adhered to. The 1650 West Steele Lane Apartments project prepared a Geotechnical Investigation (Bauer & Associates. January 3, 2019). The report found the site suitable for the proposed development as long as all of the recommendations were incorporated into the Project's building design, site preparation and foundation design. Said recommendation shall be made a part of the Project's standard conditions of approval (COA). This being a standard practice, a subsequent or new Negative Declaration or mitigated Negative Declaration is not required. The proposed Project qualifies for an Addendum.

7. GREENHOUSE GAS EMISSIONS

The NSRSASP EIR found the potential impact of the build-out of the Specific Plan area for Greenhouse Gas Emissions to be Less Than Cumulatively Considerable After Mitigation. The mitigations are:

- a. Prior to issuance of grading or building permits, all future development projects, to the extent applicable and practical, shall specify on the project plans implementation of BAAQMD-recommended construction related measures to reduce GHG emissions during construction activities. These measures include, as feasible:
 1. Use of alternative-fueled (i.e., biodiesel, electric) construction vehicles and equipment to the maximum extent possible;
 2. Use of local construction materials (within 100 miles) to the maximum extent possible; and
 3. Recycle construction waste and demolition materials to the maximum extent possible.

These mitigation measures, which are applied at time of construction, can be applied as standard COA and appended to the Building permit. They are also measures that mirror the City’s Climate Action Plan, which the Project is consistent with.

A Greenhouse Gas Assessment was prepared for the Project by Illingworth & Rodkin. June 4, 2020.

Below is a Table from the report that shows the level of GHG Emissions engendered by the Project.

Table 5. Annual Project GHG Emissions (CO₂e) in Metric Tons

Source Category	Proposed Project in 2023	Proposed Project in 2030	Proposed Project in 2035
Area	26.1	26.1	26.1
Energy Consumption	37.7	37.7	37.7
Mobile	277.2	226.5	207.5
Solid Waste Generation	8.3	8.3	8.3
Water Usage	3.2	3.2	3.2
Total (MT CO ₂ e/year)	352.5	301.8	282.8
Service Population Emissions (MT CO ₂ e/year/service population)	3.8	3.2	3.0

The report found compliance with all applicable sections of the City’s Climate Action Plan will reduce the Project’s potential GHG emission to less than significant. This mitigation is the same found in the NSRSASP. Furthermore, the Project will be constructed in accordance with the City’s recently adopted All Electric Code.

The Project’s GHG Emission did not require to be mitigated beyond that which has been adopted in the NSRSASP EIR. Hence, a subsequent or new Negative Declaration or mitigated Negative Declaration is not required. The proposed Project qualifies for an Addendum.

9. HYDROLOGY AND WATER QUALITY

Would the addition of 18 units, which is the number of units to be constructed that was not assessed by the NSRSASP EIR, increase the likelihood of the following, such that mitigations over and above that which are included in the NSRSASP EIR would be required:

Would the Project:

1. Violate water quality standards or waste discharge standards;
2. Substantially deplete ground water supplies;
3. Substantially alter existing drainage patterns by modifying a stream or a river
4. Would substantially alter drainage patterns in the area;
5. Create or contribute to run-off which would exceed the capacity of the existing drainage system;
6. Otherwise, substantially degrade water quality;
7. Place housing within the 100-year flood hazard area;
8. Place within a 100-year flood hazards area structures which would impede or redirect flood waters;
9. Expose people or structures to a significant loss, injury or death involving flooding;
10. Expose people or structures to inundation by seiche, tsunami, or mudflow?

As discussed in the NSRSASP EIR, which found all potential impacts related to Hydrology and Water Quality to be Less Than Significant, the Project is subject to the Storm Water Low Impact Development Technical Design Manual and the implementation of project-specific SWPPP. The SWPPS include erosion control/soil stabilization techniques, BMPs for prevention of discharge of construction related pollutants, drainage facility inspections, monitoring and maintenance programs. The implementation of these measures would result in potential impacts to water quality to be Less Than Significant. An Initial Storm Water Low Impact Development Submittal has been prepared for the Project by Civil Design Consultants, Inc. October 2021.

The NSRSASP EIR determined that the groundwater supply would be adequate to support the projected amount of groundwater anticipated to be pumped as a share of the potable water supply needed to support future growth in Santa Rosa. The EIR analysis assumed full build-out, which due to site specific constraints, parcel configuration, need for public or private improvements, owner preference, and such, is likely not to be realized. The additional 18 units, which is supported by State and local housing policies, represents a 0.11% increase in the number of total units projected for the Specific Plan area. This minimal increase would not substantially deplete groundwater supplies (estimated to be 2,300 acre-feet per year). Therefore, the potential impact is considered Less Than Significant.

A project specific Preliminary Drainage Study was prepared for the 1650 West Steele Lane Apartments project by Civil Design Consultants, Inc. October 14, 2021. The report found that the storm drain system that drains to Meadowbrook Court has the capacity to accept runoff

from the proposed Project. Hence, the project would not alter drainage in the area or exceed the capacity of the existing drainage system.

The project would not modify a stream or a river and the project site is not located within the 100-year flood hazard area as mapped by FEMA. Given the Project's location, there is no possibility of the project site being inundated by seiche, tsunami or mudflow.

Based on the above, the impact of the 18 additional units to hydrological and/or water quality is considered to be Less Than Significant. Mitigation measures over and above that which are required by the NSRSASP EIR are not required. A subsequent or new Negative Declaration or mitigated Negative Declaration is not necessary. The proposed Project qualifies for an Addendum.

12. NOISE

A Noise Impact Analysis was prepared for the 1650 West Steele Lane Multi-family Residential Project by First Carbon Solutions, July 2, 2020. The Project analyzed included the additional 18 units. The report determined that a significant noise impact would occur if the use (apartment project) would be exposed to transportation noise above the City's adopted land use compatibility standards of 65 dBA for ambient noise and 45 dBA for interior noise. The report found a "worst case" ambient noise level of between 62 dBA and 64 dBA. Thereby being within the City's adopted standards. The report also found that without mechanical ventilation the interior noise level would be 49 dBA, which exceeds the City's standard. However, all units will be air conditioned. By closing the windows and using the air conditioning the noise level is reduced to 39 dBA. Therefore, the Project would not result in a conflict with applicable land use noise compatibility guidelines and traffic noise impacts. Mechanical ventilation (HVAC) is part of the Project, as proposed. Therefore, it is not required as a mitigation.

The report also addressed Construction Noise Impacts, which are considered short-term noise impacts. The report recommended the following Best Management Noise Reduction Practices. The recommendation of these noise BMPs would have been required with or without additional 18 units. These noise BMPs are considered standard BMPs and can be incorporated into the Project as standard COA. Most of the BMPs are part of the City's Climate Action Plan.

Best Management Noise Reduction Practices:

- The construction contractor shall ensure that all equipment driven by internal combustion engines shall be equipped with mufflers, which are in good condition and appropriate to the equipment.
- The construction contractor shall ensure that unnecessary idling of internal combustion engines (i.e., idling in excess of 5 minutes) is prohibited.
- The construction contractor shall utilize "quiet" models of air compressors and other stationary noise sources where technology exists.

- At all times during project grading and construction, the construction contractor shall ensure that stationary noise-generating equipment shall be located as far as practicable from sensitive receptors and place so that emitted noise is directed away from adjacent residences.
- The construction contractor shall ensure that the construction staging areas shall be located to create the greatest feasible distance between the staging area and noise-sensitive receptors nearest the project site.

The report analyzed project traffic generating noise, parking lot activities, operation of the parking structure and operation of the mechanical equipment. All activities fell within acceptable noise thresholds. In addition, short-term construction vibration impacts and operational vibration impacts were analyzed. All activities were found to be significantly below the FTA's Construction Vibration Damage Criteria. No mitigation measures were required.

A project-specific noise and vibration analysis was prepared. No mitigation measures were deemed necessary. A subsequent or new Negative Declaration or mitigated Negative Declaration is not necessary. The proposed Project qualifies for an Addendum.

TRANSPORTATION/TRAFFIC

A project specific traffic study was prepared for the 1650 Steele Lane Project. The project analyzed included the 18 additional units. The report was prepared by W-Trans, March 30, 2020. The report determined that the Project would generate an average of 264 trips per day, including 17 a.m. peak hour trips and 20 p.m. peak hour trips. Site access was determined to be sufficient, as did emergency vehicle access. The project did not meet the warrants for the installation of a left-turn lane. It was recommended that parking should be prohibited through use of red-painted curb for 22 feet on either side of the Project driveway to ensure adequate sight distance. This has been incorporated in the Project design by the narrowing of the throat of the driveway.

Adequacy of on-site vehicular parking was also analyzed. The report found that although the proposed parking supply is deficient by 16 spaces, given the site's proximity to rail transit, application of ITE standard parking demand rates together with the project's proposed use of unbundled parking, the anticipated peak parking demand would be one space less than the proposed supply. Other than what has been incorporated in the project's design, no mitigation measures were recommended.

VMT

The project is within 0.25-miles of a SMART rail station. The project places higher density residential development in close proximity to rail and includes an affordable housing component. The project is exempt from preparing a VMT analysis. Additionally, the project site is shown on the City of Santa Rosa VMT screening map as exempted (<https://srcity.org/3313/Vehicle-Miles-Traveled>).

Based on the above, a subsequent or new Negative Declaration or mitigated Negative Declaration is not necessary. The proposed Project qualifies for an Addendum.

4. CONCLUSION

The proposed Project has been evaluated for any related environmental consequences in this Addendum and in the technical reports referenced herein. All such reports are available for public inspection at the City of Santa Rosa Department of Planning and Economic Development or at the City's Web page @srcity.org.

On the basis of the analysis in this Addendum and the technical reports, the proposed Project does not cause new significant environmental effects or substantial increases in the severity of a significant environmental effect identified in the NSRSASP EIR prepared for the project area. There are no substantial changes in circumstances affecting the 1650 West Steele Lane Apartments project, which would cause increased environmental impacts. Although there is new information, which was not known and could not have been known at the time of the NSRSASP EIR, analysis of that new information or regulations applied to the proposed Project shows no new or more severe environmental effects. Furthermore, no infeasibility of adopted mitigation measures, no new feasible mitigation measures which the applicant declines to adopt, or no alternatives different from those in the NSRSASP EIR, which would substantially reduce effects on the environment were discovered.

Approval of the proposed Project would not meet any of the requirements in Public Resources Code Section 21166 or in CEQA Guidelines Section 15162 for preparation of a subsequent Negative Declaration or a supplement to the Negative Declaration.

Source Documents Used to Prepare the Addendum

1. Project Applications and Design Narrative: Hedgpeth Architects. Ingrid Anderson. January 20, 2021.
2. Project Plans: West Steele Lane Apartments. Minor Design Review Submittal Set. January 20, 2021.
Architect: Hedgpeth Architects
Civil Engineer: Civil Design Consultants, Inc.
Landscape Architect: McNair Landscape Architects
3. 2020 CEQA Statute & Guidelines. Association of Environmental Professionals. 2020
4. City of Santa Rosa General Plan 2035.
5. City of Santa Rosa Zoning Code
6. City of Santa Rosa Climate Action Plan
7. North Santa Rosa Station Area Specific Plan (NSRSASP). PMC; W-Trans; Strategic Economics; Coastland Engineers. September 18, 2012.
8. North Santa Rosa Station Area Specific Plan EIR. PMC. April 2012.
9. North Santa Rosa Station Area Specific Plan Mitigation Monitoring and Reporting Program. City of Santa Rosa. June 2012.
10. City Council of the City of Santa Rosa also adopted Ordinance No. ORD-2019-002 on January 15, 2019
11. Resolution No. RES-2019-002. City Council City of Santa Rosa. Adopting a Negative Declaration for Density Bonus within DSASP and the NSRSASP Boundaries.
12. West Steele Lane Apartments Air Quality and Greenhouse Gas Emission Assessment. Illingworth & Rodkin, Inc. June 4, 2020.
13. Noise Impact Analysis Report 1650 West Steele Lane Multi-family Residential Project. First Carbon Solutions. July 2, 2021
14. Geotechnical Investigation 1650 West Steele Lane Apartments. Bauer Associates, Inc. January 3, 2019.
15. Biological Evaluation 1650 West Steele Lane, Santa Rosa, CA. Wiemeyer Ecological Sciences. December 1, 2020.
16. Traffic Study for the 1650 Steele Lane Project. W-Trans. March 30, 2020.
17. Cultural Resources Study of the Property at 1650 West Steele Lane Santa Rosa, Sonoma county, California. Tom Origer & Associates. July 20, 2020.
18. Preliminary Drainage Study for Steele Lane Apartments. Civil Design Consultants, Inc. October 14, 2021.
19. Initial Storm Water Low Impact Development Submittal for Steele Lane Apartments. Civil Design Consultants, Inc. October 2021.

Wiemeyer Ecological Sciences
4000 Montgomery Drive, Suite L-5
Santa Rosa, CA 95405
(707) 573-1770

December 1, 2020

Patrick O'Neil
19 Leona Drive
San Rafael, CA 94903

SUBJECT: BIOLOGICAL EVALUATION – 1650 WEST STEELE LANE, SANTA ROSA, CA

Dear Mr. O'Neil,

Wiemeyer Ecological Sciences (WES) has prepared this Biological Evaluation for the site located at 1650 West Steele Lane in Santa Rosa, CA. The intent of the Biological Evaluation is to provide information on the habitats at the site, including any sensitive habitats, and a discussion of habitat suitability for any for special-status plant and animal species that have the potential to occur at the site.

A site visit was performed at the site by Darren Wiemeyer on July 17, 2020. The site is completely surrounded by residential and commercial developments. Past land uses are unknown, but may have previously been a rural residence. There are no structures on the site. Photos of the site are included in Photo Plate A (attached).

The site consists entirely of non-native annual grassland habitat (Figure 1). The non-native annual grassland habitat is dominated by non-native grasses and forbs with several areas of ruderal (disturbed) areas. There are several trees on the site, including four valley oak trees, which would be considered heritage trees according to the City of Santa Rosa Tree Preservation Ordinance. The other trees species on the site include California walnut, sycamore, silver poplar and silver wattle, which are not considered heritage trees.

The non-native annual grassland habitat and degraded areas at the site would not support any special-status plant species as the non-native species will out-compete native and/or special-status plant species. The site would provide suitable nesting habitat for native birds, including birds of prey. The larger trees at the site could provide potentially suitable habitat for roosting bats as these trees exhibited cavities and exfoliating bark.

The proposed project is an apartment complex (Site Plan attached). The majority of the site is proposed to be developed resulting in the loss of non-native annual grassland habitat as well as several trees, including four valley oak trees.

Site developments have the potential to impact native nesting birds and roosting bats. The following avoidance and mitigation measures will mitigate for the loss of four valley oak heritage trees and to avoid significant impacts to nesting birds and roosting bats.

Valley Oak Heritage Trees

To mitigate for the loss of four valley oak trees at the Project Site, a Tree Removal Permit will be obtained and tree replacement will be performed in accordance with the City of Santa Rosa Tree Preservation Ordinance.

Nesting Birds

To ensure that nesting birds are not disturbed as a result of tree trimming, tree removal and construction activities, it is recommended that pre-construction surveys for nesting birds be performed prior to the initiation of tree trimming, tree cutting, grubbing and construction activities.

Mitigation Measures

A qualified biologist shall perform a pre-construction survey for nesting birds within 48 hours prior to tree removal and/or ground breaking at the site if construction activities will take place between February 1 and August 31. If nesting birds are found, the qualified biologist shall establish suitable buffers prior to tree removal and/or ground breaking activities. To prevent encroachment, the established buffer(s) shall be clearly marked by highly visibility material. The established buffer(s) shall remain in effect until the young have fledged or the nest has been abandoned as confirmed by the qualified biologist. To more effectively identify active nests and to facilitate project scheduling, it is recommended that initial nesting surveys begin as early as February when the foliage on the trees are at a minimum and the nest building activity is high.

Roosting Bats

To ensure that actively roosting bats are not disturbed as a result of tree trimming and tree removal, it is recommended that specific mitigation measures be implemented to avoid impacts to bat species.

Mitigation Measures

- 1. The pruning or removal of living trees or snags must not occur during the maternity season between April 1 and September 1 to minimize the disturbance of young that may be present and unable to fly.*
- 2. The pruning or removal of living trees or snags must occur between the hours of 12 pm and sunset on days after nights when low temperatures were 50° For warmer to minimize impacting bats that may be present in deep torpor. Sunset times shall be obtained from http://aa.usno.navy.mil/data/docs/RS_OneDay.php and temperatures for prior-work nights shall be obtained from <http://www.wunderground.com/history/>*

3. *When it is necessary to perform crown reduction on trees over 12 inches in diameter breast height or remove entire trees or branches over six inches in diameter there shall be preliminary pruning of small branches less than 2 inches in diameter performed the day before. The purpose of this is to minimize the probability that bats would choose to roost in those trees the night before the work is performed.*

If it is not possible to implement Measures 2 and/or 3, then a qualified bat biologist will be required in order to conduct tree cavity surveys and humanely evict roosting bats within 24 hours of vegetation management activities. Measure 1 (avoidance of maternity season is critical as young bats that are not able to fly cannot be humanely evicted).

If you have any questions regarding this Biological Evaluation, please feel free to contact me.

Thank you,



Darren Wiemeyer

Darren@wiemeyerecologicalsciences.com

Attachments: Figure 1 – Habitat Map
 Photo Plate A
 Site Plan



Site Boundary
 NAG - Non-native annual grassland

<p>Figure 1 - Habitat Map</p> <p>1650 W. Steele Lane Santa Rosa, CA Sonoma County APN: 041-042-012</p>	<p>0 5 10 20 30 40 Feet</p> 	<p>Parcel boundary and imagery (2018) provided by Sonoma County Map date: 10/2020</p>
-----------------------------------------------------------------------------------------------------------------------------------------	-----------------------------------------------------------------------------------------------------------------	-------------------------------------------------------------------------------------------------------------------------------------------



A-1: Southeastern portion of site showing non-native grassland.



A-2: Northeastern portion of site showing non-native grassland.



A-3: Center of site showing non-native grassland.



A-4: Two valley oak trees in center of site.



A-5: Northern portion of site showing non-native grassland.



A-6: Southern portion of site showing non-native grassland.

Steele Lane Apartments
1650 West Steele Lane
Santa Rosa, CA
APN 041-042-012

PHOTO PLATE A

WIEMEYER ECOLOGICAL SCIENCES
4000 MONTGOMERY DRIVE, SUITE L-5
SANTA ROSA, CA 95405
(707) 573-1770

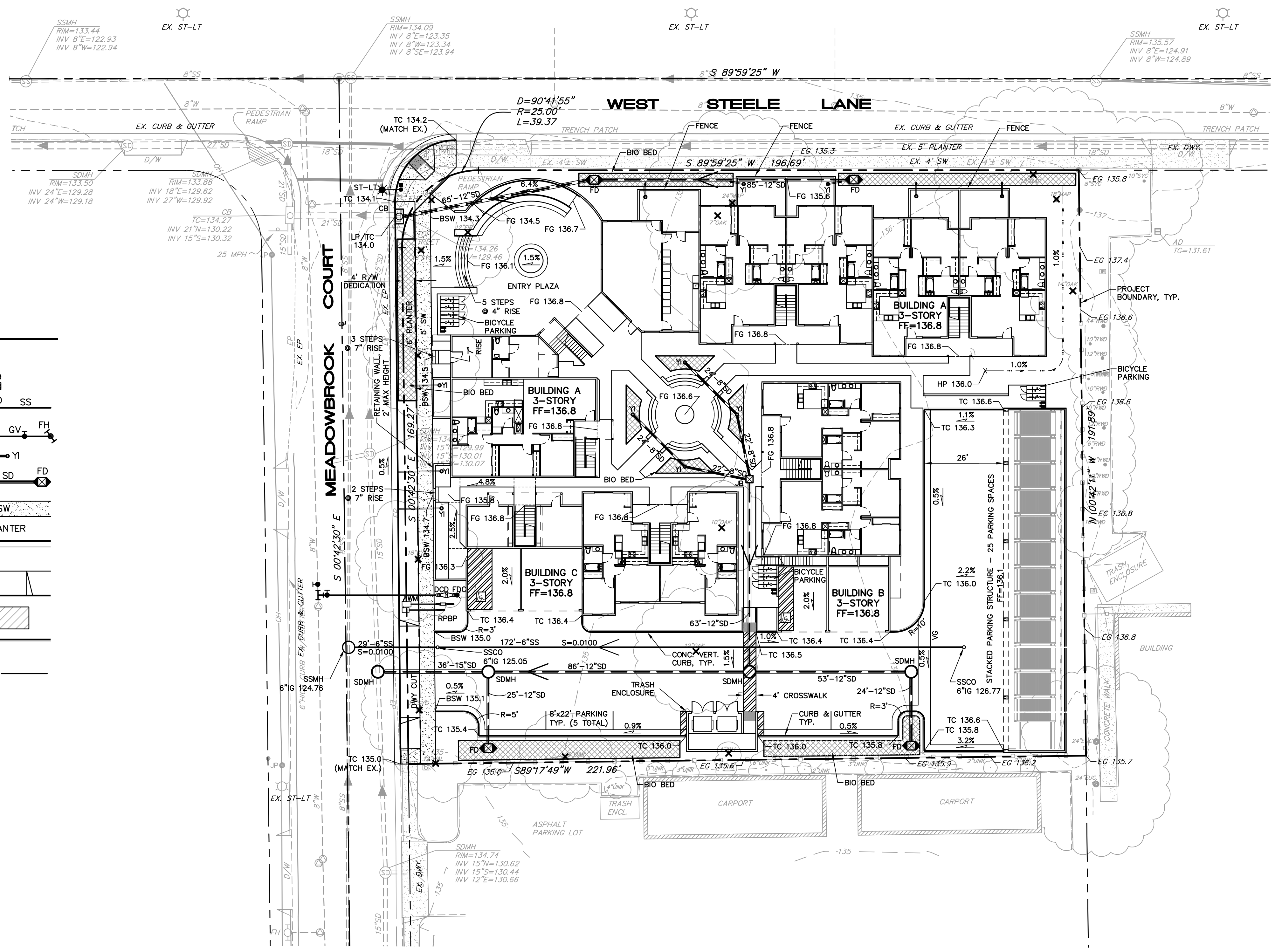
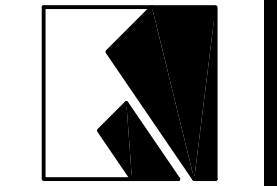

LEGEND

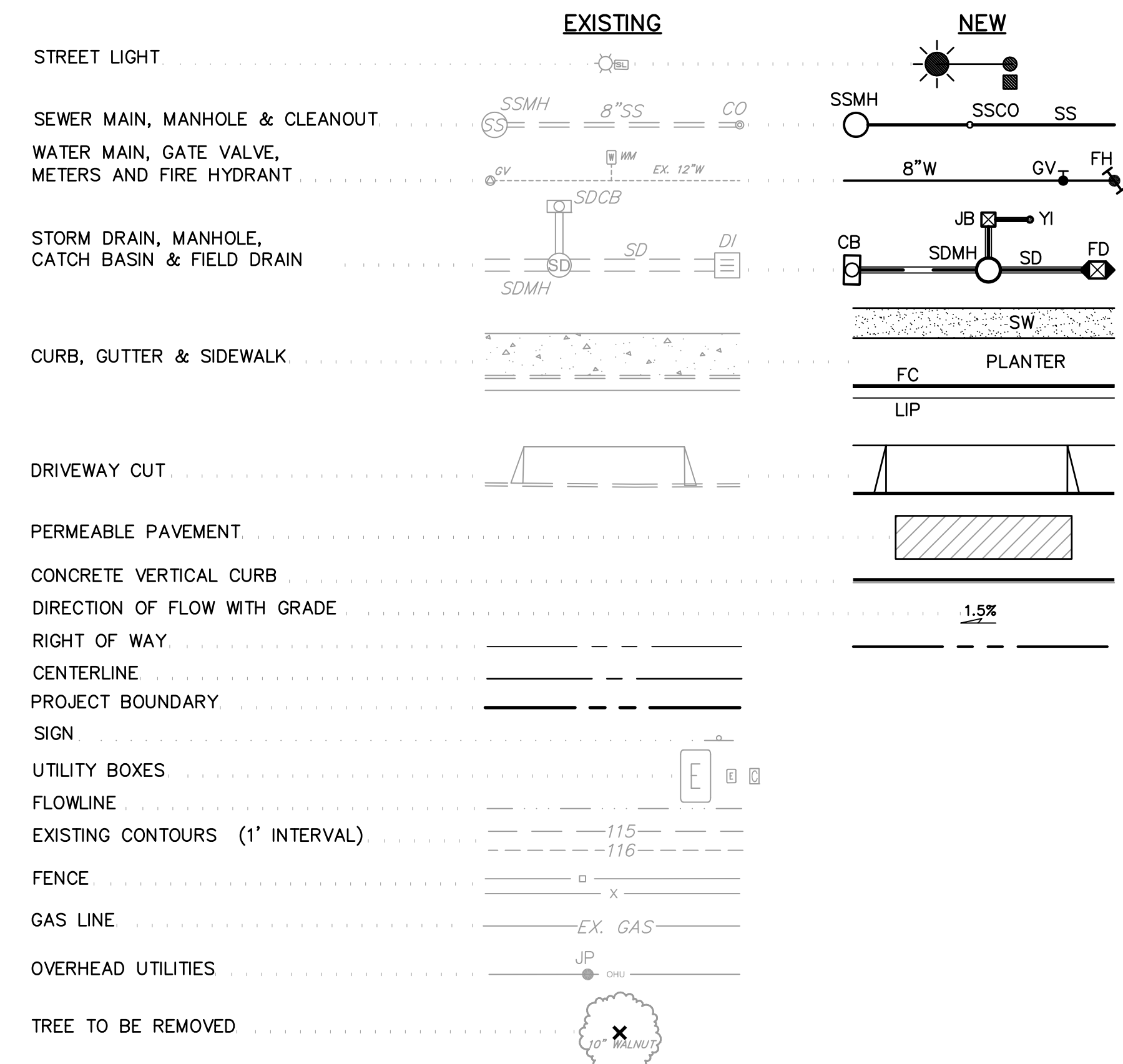

ABBREVIATIONS

ADA	AMERICANS WITH DISABILITIES ACT
APN	ASSESSORS PARCEL NUMBER
BSW	BACK OF SIDEWALK
CB	CATCH BASIN
CONC	CONCRETE
DCD	DOUBLE CHECK DETECTOR
DN	DOCUMENT NUMBER
EG	EXISTING GRADE
EP	EDGE OF PAVEMENT
EX	EXISTING
FD	FIELD DRAIN
FDC	FIRE DEPARTMENT CONNECTION
FF	FINISH FLOOR
FG	FINISH GRADE
FH	FIRE HYDRANT
FL	FLOW LINE
GV	GATE VALVE
HP	HIGH POINT
IG	INVERT GRADE
JB	JUNCTION BOX
LP	LOW POINT
R	RADIUS
R/W	RIGHT OF WAY
RPBP	REDUCED PRESSURE BACKFLOW PREVENTOR
S	SLOPE OR SOUTH
SDMH	STORM DRAIN MANHOLE
SO	SIDE OPENING
SS	SANITARY SEWER
SSCO	SANITARY SEWER CLEAN OUT
SSMH	SANITARY SEWER MANHOLE
ST-LT	STREET LIGHT
SW	SIDEWALK
SWE	SIDEWALK EASEMENT
TC	TOP OF CURB
TYP	TYPICAL
VERT	VERTICAL
VG	VALLEY GUTTER
W	WATER OR WEST
WM	WATER METER
YI	YARD INLET

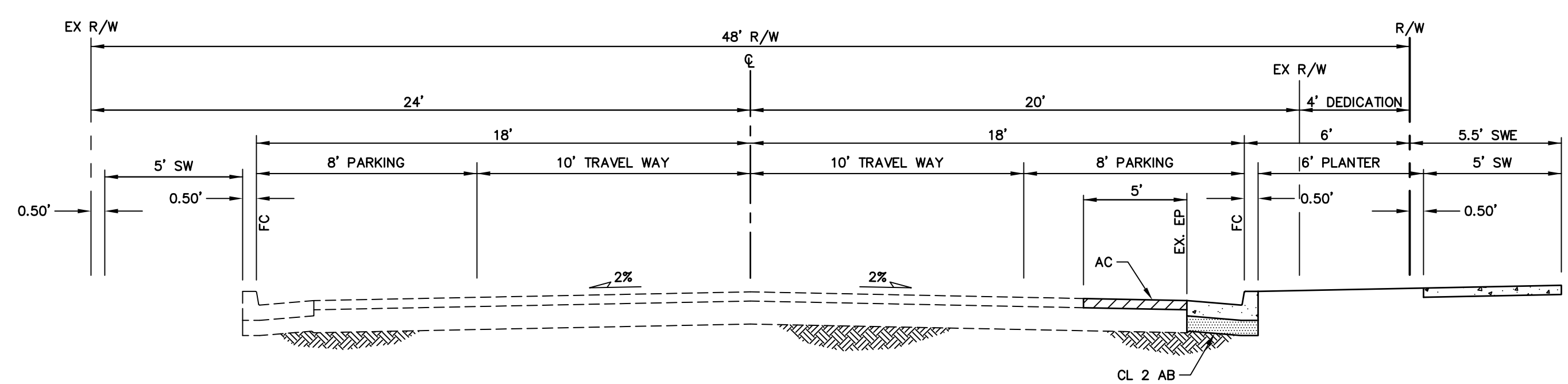

MINOR STREET - PUBLIC
MEADOWBROOK COURT

NO SCALE

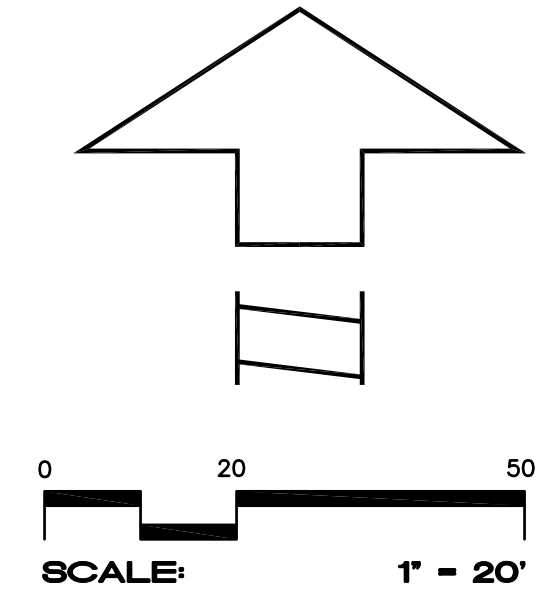

S:\2019\19-107\19-107-01\19-107-01-01.dwg: Andrew Bordezza: 11/15/2019 10:56:08 AM

**Cultural Resources Study of the Property at
1650 West Steele Lane
Santa Rosa, Sonoma County, California**

Eileen Barrow, MA/RPA

July 20, 2020



**Cultural Resources Study of the Property at
1650 West Steele Lane
Santa Rosa, Sonoma County, California**

Prepared by:

Eileen Barrow, MA/RPA

Tom Origer & Associates
Post Office Box 1531
Rohnert Park, California 94927
(707) 584-8200

Prepared for:

J. Kapolchok & Associates
843 Second Street
Santa Rosa, California 95404

July 20, 2020

ABSTRACT

Tom Origer & Associates conducted a cultural resources study of the property at 1650 West Steel Lane, Santa Rosa, Sonoma County, California. The study was requested by J. Kapolchok & Associates on behalf of Patrick O'Neill, the project proponent. This study was conducted to meet the requirements of the City of Santa Rosa and those of the California Environmental Quality Act. The purpose of this report is to identify potential historical resources other than Tribal Cultural Resources, as defined in Public Resources Code [PRC] 21074 (a)(1)(A)-(B) and discussed in the Regulatory Context section). Tribal Cultural Resources are defined in Public Resources Code [PRC] 21074 (a)(1)(A)-(B).

The project proponent is proposing to develop the property into multi-residential housing.

This study included archival research at the Northwest Information Center, Sonoma State University, examination of the library and files of Tom Origer & Associates, Native American contact, and field inspection of the study area. No cultural resources were found within the study area.

This report contains information about the locations of archaeological sites. For the protection of these resources, this report, and such location information, should not be publicly circulated.

Synopsis

Project: 1650 West Steele Lane
Location: 1650 West Steele Lane, Santa Rosa, Sonoma County
APN: 041-042-012
Quadrangles: Santa Rosa 7.5' series
Study Type: Intensive
Scope: 0.98 acres
Field Hours: 1 person-hour
NWIC #: 19-2058
TOA #: 2020-027
Finds: None

Key Personnel

Eileen Barrow

Ms. Barrow conducted archival research, conducted the fieldwork, and authored this report. Ms. Barrow has been with Tom Origer & Associates since 2005. She holds a Master of Arts in cultural resources management from Sonoma State University. Mrs. Barrow's experience includes work in compliance with local ordinances, California Environmental Quality Act, National Environmental Policy Act, and Section 106 of the National Historic Preservation Act requirements. Her professional affiliations include the Society for American Archaeology, the Society for California Archaeology, the California Historical Society, and the Sonoma County Historical Society.

CONTENTS

ABSTRACT i
 Synopsis..... i
 Key Personnel.....ii
INTRODUCTION 1
REGULATORY CONTEXT..... 1
 Resource Definitions 2
 Significance Criteria..... 2
PROJECT SETTING 3
 Study Area Location and Description 3
 Cultural Setting..... 5
STUDY PROCEDURES AND FINDINGS 9
 Native American Contact 9
 Native American Contact Results..... 9
 Archival Research Procedures 10
 Archival Research Findings..... 10
 Field Survey Procedures 11
 Field Survey Findings..... 11
DISCUSSION AND RECOMMENDATIONS 12
 Archaeological Recommendations 12
 Built Environment Recommendations..... 12
 Accidental Discovery 12
SUMMARY..... 12
MATERIALS CONSULTED..... 13

APPENDIX A: Native American Contact

FIGURES

Figure 1. Project vicinity (adapted from the 1980 Santa Rosa 1:250,000-scale USGS map)..... 1
Figure 2. Study area location (adapted from the 1993 Santa Rosa 7.5’ USGS topographic map)..... 4
Figure 3. Overview photo of the study area, facing northeast. 5

TABLES

Table 1. North Bay/San Francisco Bay Area Chronology..... 7
Table 2. Studies within a Quarter-mile of the Study Area..... 11

INTRODUCTION

This report describes a cultural resources study of the property at 1650 West Steele Lane, Santa Rosa, Sonoma County, California (Figure 1). The study was requested and authorized by J. Kapolchok & Associates on behalf of Patrick O’Neill, the project proponent. This study was conducted in compliance with the requirements of the City of Santa Rosa and those of the California Environmental Quality Act (CEQA). The project proponent is proposing to develop the property into multi-residential housing. Documentation pertaining to this study is on file at Tom Origer & Associates (File No. 2020-027).

REGULATORY CONTEXT

The State of California requires that cultural resources be considered during the environmental review process. This process is outlined in CEQA and accomplished by an inventory of resources within a study area and by assessing the potential that historical resources could be affected by development. The term “Historical Resources” encompasses all forms of cultural resources including prehistoric and historical archaeological sites and built environment resources (e.g., buildings, bridges, canals), that would be eligible for inclusion on the California Register of Historical Resources (California Register). An additional category of resources is defined in CEQA under the term “Tribal Cultural Resources” (Public Resources Code Section 21074). They are not addressed in this report because Tribal Cultural Resources are resources that are of specific concern to California Native American tribes, and knowledge of such resources is limited to tribal people. Pursuant to CEQA, as revised in July 2015, such resources are to be identified by tribal people in direct, confidential consultation with the lead agency (PRC §21080.3.1).

This cultural resources study was designed to satisfy environmental issues specified in the CEQA and its guidelines (Title 14 CCR §15064.5) by: (1) identifying historical resources within the project area;

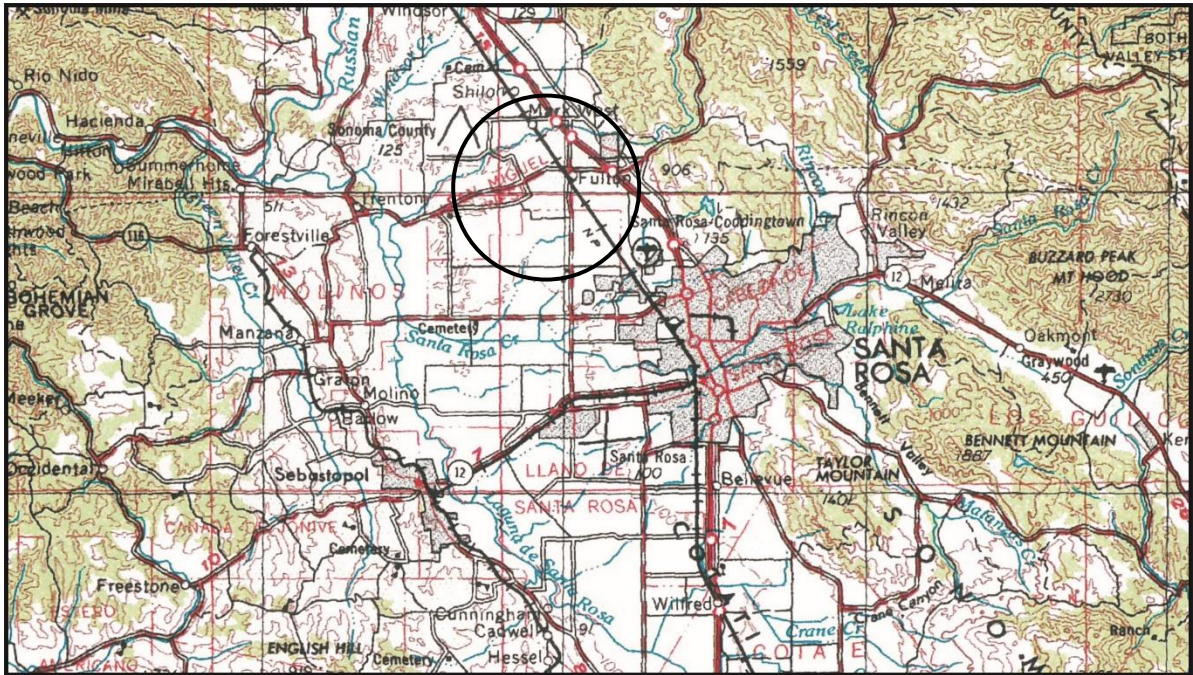

Figure 1. Project vicinity (adapted from the 1980 Santa Rosa 1:250,000-scale USGS map).

(2) offering a preliminary significance evaluation of the identified cultural resources; (3) assessing resource vulnerability to effects that could arise from project activities; and (4) offering suggestions designed to protect resource integrity, as warranted.

Resource Definitions

Historical resources are classified by the State Office of Historic Preservation (OHP) as sites, buildings, structures, objects, and districts, and each is described by OHP (1995) as follows.

Site. A site is the location of a significant event, a prehistoric or historic occupation or activity, or a building or structure, whether standing, ruined, or vanished, where the location itself possesses historic, cultural, or archaeological value regardless of the value of any existing structure.

Building. A building, such as a house, barn, church, hotel, or similar construction, is created principally to shelter any form of human activity. “Building” may also be used to refer to a historically and functionally related unit, such as a courthouse and jail, or a house and barn.

Structure. The term “structure” is used to distinguish from buildings those functional constructions made usually for purposes other than creating human shelter.

Object. The term “object” is used to distinguish from buildings and structures those constructions that are primarily artistic in nature or are relatively small in scale and simply constructed. Although it may be, by nature or design, movable, an object is associated with a specific setting or environment.

District. A district possesses a significant concentration, linkage, or continuity of sites, buildings, structures, or objects united historically or aesthetically by plan or physical development.

Significance Criteria

When a project might impact a cultural resource, the project proponent is required to conduct an assessment to determine whether the impact may be one that is significant. Consequently, it is necessary to determine the importance of resources that could be impacted. The importance of a resource is measured in terms of criteria for inclusion on the California Register. A resource may be important if it meets any one of the criteria, or if it is already listed on the California Register or a local register (Title 14 CCR, §4852).

An important resource is one which:

1. Is associated with events that have made a significant contribution to the broad patterns of local or regional history, or the cultural heritage of California or the United States.
2. Is associated with the lives of persons important to local, California, or national history.
3. Embodies the distinctive characteristics of a type, period, region or method of construction, or represents the work of a master or possesses high artistic values.

4. Has yielded, or may be likely to yield, information important to the prehistory or history of the local area, California, or the nation.

In addition to meeting one or more of the above criteria, eligibility for the California Register requires that a resource retains sufficient integrity to convey a sense of its significance or importance. Seven elements are considered key in considering a property's integrity: location, design, setting, materials, workmanship, feeling, and association.

The OHP advocates that all resources over 45 years old be recorded for inclusion in the OHP filing system (OHP 1995:2), although the use of professional judgment is urged in determining whether a resource warrants documentation.

PROJECT SETTING

Study Area Location and Description

The study area is within the Santa Rosa Plain, a northwest-trending valley at the southern end of the Northern Coast Ranges. Twenty-two miles long and nine miles wide at its widest point, the Santa Rosa Plain was once a broad savannah cross-cut by seasonal streams that drained toward the area now known as the Laguna de Santa Rosa. Santa Rosa Creek and Mark West Creek, year-round tributaries to the laguna, are the main westerly flowing streams on the plain. In addition to vast grasslands, plant communities include oak woodlands and vernal pools (Honton and Sears 2006).

The study area is located at 1650 West Steele Lane (APN 041-042-012), Santa Rosa, Sonoma County, as shown on the Santa Rosa 7.5' USGS topographic map (Figure 2). This part of Santa Rosa is largely comprised of residential subdivisions with occasional commercial complexes. Figure 3 provides a current overview of the study area.

The study area consists of 0.98 acres situated on generally level land with a percent slope of less than 1%. The closest water source is Paulin Creek, which is located 345 meters north of the study area. Paulin Creek has been channelized, though it appears to be in approximately the same location as when it naturally flowed north of the study area.

The geology of the study area consists of alluvial deposits that date to the Holocene (11,700 years ago to the present) (McLaughlin *et al.* 2008). As a point of note, naturally-occurring obsidian, known as "float," occurs in the vicinity of Santa Rosa, especially toward the north (McLaughlin *et al.* 2003; personal communication Tom Origer and Vicki Beard 2019). Typically, float specimens are approximately five centimeters in diameter and smaller. Native Americans used obsidian for making tools, though typically float found in the Santa Rosa area is too small to be formed into tools.

Soils within the study area belong to the Zamora series (Miller 1972: Sheet 74). Zamora soils consist of well-draining clay loams found on alluvial fans. In a natural state, this soil supports the growth of grasses, forbs, and scattered oaks. Historically, parcels containing Zamora soils were used for vineyards, orchards, row and truck crops, and irrigated areas were used for pasture and hay crops (Miller 1972:90).

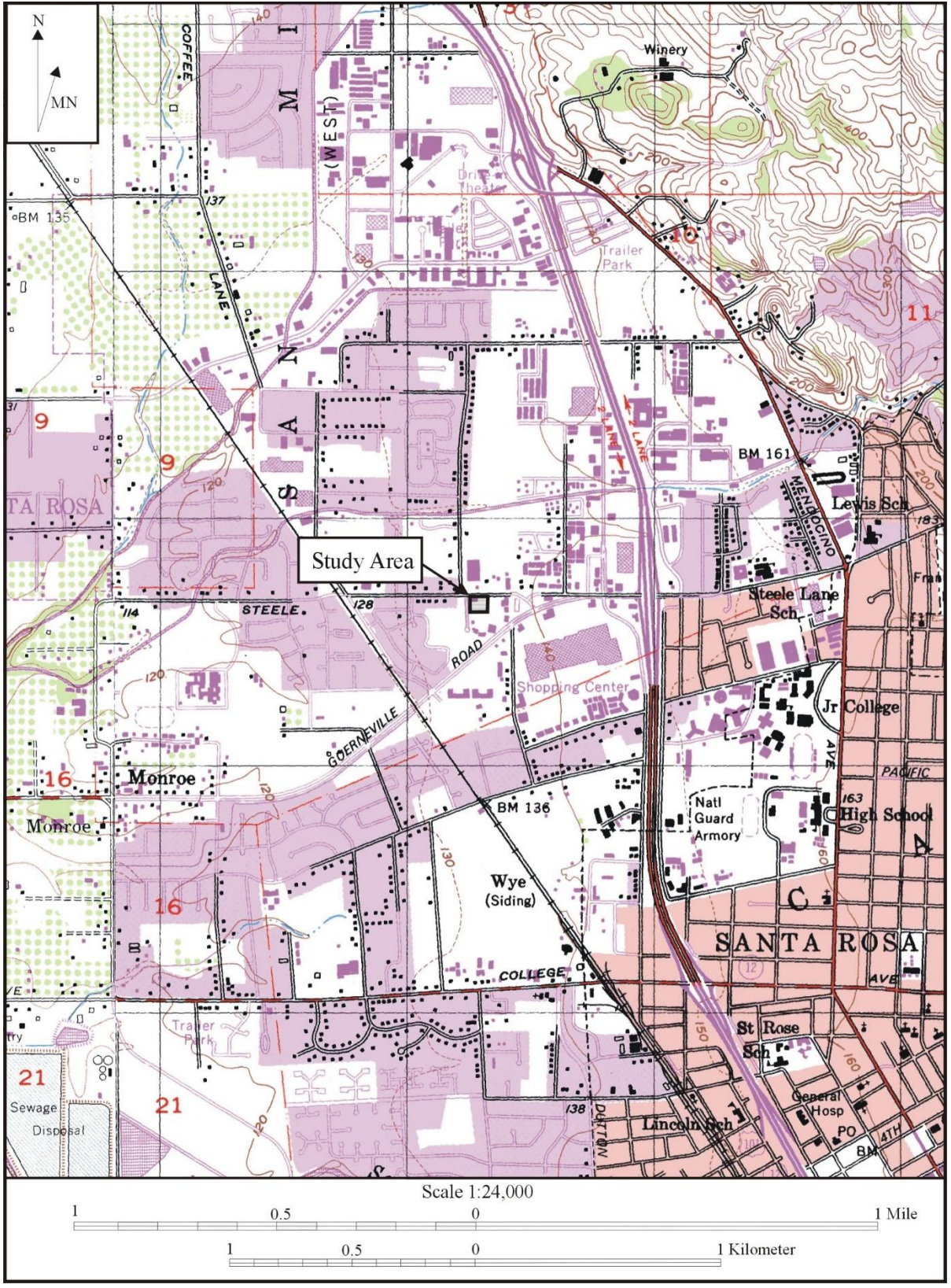

Figure 2. Study area location (adapted from the 1993 Santa Rosa 7.5' USGS topographic map).



Figure 3. Overview photo of the study area, facing northeast.

Cultural Setting

Prehistory

The concept of prehistory refers to the period of time before events were recorded in writing and vary worldwide. Because there is no written record, our understanding of California prehistory relies on archaeological materials and oral histories passed down through generations. Early archaeological research in this area began with the work of Max Uhle and Nels Nelson. Uhle is credited with the first scientific excavation in California with his work at the Emeryville Shellmound in 1902, and Nelson spent several years (1906 to 1908) surveying the San Francisco Bay margins and California coast for archaeological sites (Nelson 1909). In the 1930s, archaeologists from Sacramento Junior College and the University of California began piecing together a sequence of cultures primarily based on burial patterns and ornamental artifact from sites in the lower Sacramento Valley (Lillard *et al.* 1939; Heizer and Fenenga 1939). Their cultural sequence became known as the Central California Taxonomic System (CCTS), which identified three culture periods termed the Early, Middle, and Late Horizons, but without offering date ranges. Refinement of the CCTS became a chief concern of archaeologists as the century progressed with publications by Richard Beardsley (1948, 1954) and Clement Meighan (1955) based on materials excavated by the University of California archaeological survey.

In 1973, David Fredrickson synthesized prior work, and in combination with his own research, he developed a regional chronology that is used to this day, albeit modified for locality-specific circumstances. Fredrickson's scheme shows that native peoples have occupied the region for over 11,000 years (which is supported by Erlandson *et al.* 2007), and during that time, shifts took place in their social, political, and ideological regimes (Fredrickson 1973). While Fredrickson's chronology was adopted by many archaeologists, Beardsley's cultural sequence was adopted by others creating a roughly North Bay-South Bay division in usage.

In an effort to bridge the differences between chronologies, Milliken *et al.* (2007: Figure 8.4) presented a concordance for comparing time periods, cultural patterns, and local variations for the San Francisco

Bay Area. Milliken included Dating Scheme D, as presented by Groza in 2002, which is a refinement of previous radiocarbon-based temporal sequences for the San Francisco Bay Area. More recently, Byrd, Whitaker, Mikkelsen, and Rosenthal (2017) called upon archaeologists to abandon previous temporal sequences in favor of Scheme D, further refined in Groza *et al.* 2011. Table 1 assimilates Scheme D, Fredrickson's (1973) chronology, and the obsidian hydration dating scheme from Origer (1987). Note that the Early, Middle, Late Horizon scheme is still evident though refinements have been made within those categories.

Early occupants appear to have had an economy based largely on hunting, with limited exchange, and social structures based on the extended family unit. Later, milling technology and an inferred acorn economy were introduced. This diversification of economy appears to be coeval with the development of sedentism and population growth and expansion. Sociopolitical complexity and status distinctions based on wealth are also observable in the archaeological record, as evidenced by an increased range and distribution of trade goods (e.g., shell beads, obsidian tool stone), which are possible indicators of both status and increasingly complex exchange systems.

These horizons or periods are marked by a transition from large projectile points and millingslabs, indicating a focus on hunting and gathering during the Early Period, to a marine focus during the Middle Period evidenced by the number of shellmounds in the Bay Area. The Middle Period also saw more reliance on acorns and the use of bowl-shaped mortars and pestles. Acorn exploitation increased during the Late Period and the bow and arrow were introduced.

Prehistoric archaeological site indicators expected to be found in the region include but are not limited to: obsidian and chert flakes and chipped stone tools; grinding and mashing implements such as slabs and hand-stones, and mortars and pestles; and locally darkened midden soils containing some of the previously listed items plus fragments of bone, shellfish, and fire-affected stones.

Table 1. North Bay/San Francisco Bay Area Chronology

Temporal Period ¹	Approximate Time Range ¹	~ Hydration Interval (μ) ²	Scheme D Periods ³	Approximate Time Range ³	~ Hydration Interval (μ) ²
Historical	< AD 1800	<1.20	Historic Mission	AD 1835 to AD 1770	1.10 - 1.27
Upper Emergent	AD 1800 to AD 1500	1.21 - 1.84	Late 2	AD 1770 to AD 1520	1.28 - 1.80
Lower Emergent	AD 1500 to AD 1000	1.85 - 2.58	Late 1b	AD 1520 to AD 1390	1.81 - 2.02
			Late 1a	AD 1390 to AD 1265	2.03 - 2.22
			Middle/Late Transition	AD 1265 to AD 1020	2.23 - 2.55
Upper Archaic	AD 1000 to 500 BC	2.59 - 4.05	Middle 4	AD 1020 to AD 750	2.56 - 2.88
			Middle 3	AD 750 to AD 585	2.89 - 3.06
			Middle 2	AD 585 to AD 420	3.07 - 3.23
			Middle 1	AD 420 to 200 BC	3.24 - 3.80
Middle Archaic	500 BC to 3000 BC	4.06 - 5.72	Early/Middle Transition	200 BC to 600 BC	3.81 - 4.13
			Early	600 BC to 2100 BC	4.14 - 5.18
Lower Archaic	3000 BC to 6000 BC	5.73 - 7.23			
Paleo-Indian	6000 BC to 8000 BC	7.24 - 8.08+			

μ = microns

¹ based on Fredrickson (1994)

² based on Napa Glass Mountain rate by Origer (1987) and Effective Hydration Temperature value from the vicinity of Santa Rosa, Sonoma County

³ based on Groza *et al.* (2011)

Ethnography

Linguists and ethnographers tracing the evolution of languages have found that most of the indigenous languages of the California region belong to one of five widespread North American language groups (the Hokan and Penutian phyla, and the Uto-Aztecan, Algic, and Athabaskan language families). The distribution and internal diversity of four of these groups suggest that their original centers of dispersal were outside, or peripheral to, the core territory of California, that is, the Central Valley, the Sierra Nevada, the Coast Range from Cape Mendocino to Point Conception, and the Southern California coast and islands. Only languages of the Hokan phylum can plausibly be traced back to populations inhabiting parts of this core region during the Archaic period, and there are hints of connections between certain branches of Hokan, such as that between Salinan and Seri, that suggest that at least some of the Hokan languages could have been brought into California by later immigrants, primarily from the Southwest and northwestern Mexico (Golla 2011).

At the time of European settlement, people inhabiting this area spoke Southern Pomo, one of seven mutually unintelligible Pomoan languages belonging to the Hokan language stock. The Southern Pomo's aboriginal territory falls within present-day Sonoma County. To the north, it reaches the divide between Rock Pile Creek and the Gualala River, and to the south, it extends to near the town of Cotati. The eastern boundary primarily runs along the western flanks of Sonoma Mountain until it reaches Healdsburg, where it crosses to the west side of the Russian River. Within the larger area that constitutes the Southern Pomo homelands, there were bands or tribelets that occupied distinct areas. Primary village sites of the Southern Pomo were occupied continually, while temporary sites were visited to procure resources that were especially abundant or available only during certain seasons. Sites often were situated near freshwater sources and in ecotones where plant life and animal life were diverse and abundant.

The Southern Pomo population was decimated early in the historic period, especially in the southern part of their territory. Ethnic identity was severely impacted in the region of Santa Rosa and Sebastopol; McLendon and Oswalt (1978: 279) reported that the few Southern Pomo speakers remaining in 1976 were from north of Healdsburg. For more information about the Pomo, see Bean and Theodoratus (1978), Kniffen (1939), and Stewart (1943).

History

Historically, the study is west of Santa Rosa, as originally platted. The town of Santa Rosa included the blocks between 1st and 5th streets and between present-day Morgan Street on the west and just beyond E Street to the east (Brewster 1854). Green's Addition was the first expansion of the town, moving the limits northward toward present-day Cherry Street. Outlying parcels varied in size, tending to increase in acreage as they got further from the town center. The study area is outside of what was originally plotted as Santa Rosa.

With the end of World War II, Santa Rosa experienced a population boom, much like the rest of the nation. Census data show that the city had 12,605 people enumerated in 1940, and over the next ten years, the number rose to 17,902 (State of California Department of Finance 2011). By 1960, Santa Rosa boasted a population of just over 31,000 people, nearly tripling in size in just 20 years. To accommodate this growth, entire neighborhoods were erected in short order, and the outward movement of families to the suburbs, which had begun during the late nineteenth century, recommenced with due speed. Much of this growth was bolstered by benefits extended to returning service members and their families. The Servicemen's Readjustment Act of 1944 (also known as the G.I. Bill of Rights) included several programs to ease World War II veterans back into the local economy while avoiding a return to the pre-war depression. Among those benefits was a military loan guarantee program to help purchase

homes. In 1950, homeownership in California had risen 11 percent over the proceeding decade and was at an all-time high of 58 percent by 1960.

The years following World War II brought unprecedented well-being to Americans, and commerce flourished as people grew more comfortable with spending. Immediately after World War II, new commercial buildings generally were in downtown areas and other existing commercial centers. Bolstered by post-war consumer confidence, new housing developments appeared, and with them the need for more schools, new churches, and new commercial enterprises. By the end of the 1950s, new commercial construction was usually located in the new suburbs at the edge of town. In Santa Rosa, Hugh Coddling led the way with several housing and commercial developments, including Brookwood Terrace, Town & Country Village, and Montgomery Village. These subdivisions tended to have their own commercial areas, and often social features as well.

Historic period site indicators generally include: fragments of glass, ceramic, and metal objects; milled and split lumber; and structure and feature remains such as building foundations and discrete trash deposits (e.g., wells, privy pits, dumps).

STUDY PROCEDURES AND FINDINGS

Native American Contact

A request was sent to the State of California's Native American Heritage Commission (NAHC) seeking information from the Sacred Lands File and the names of Native American individuals and groups that would be appropriate to contact regarding this project. Letters were also sent to the following groups:

- Cloverdale Rancheria of Pomo Indians of California
- Dry Creek Rancheria of Pomo Indians
- Federated Indians of Graton Rancheria
- Guidiville Band of Pomo Indians
- Kashia Band of Pomo Indians of the Stewarts Point Rancheria
- Lytton Rancheria of California
- Middletown Rancheria of Pomo Indians of California
- Mishewal-Wappo Tribe of Alexander Valley

This contact does not constitute consultation with tribes.

Native American Contact Results

The NAHC replied with a letter dated May 29, 2020, which indicated that the Sacred Lands File has no information about the presence of Native American cultural resources in the immediate project area. A list of additional contacts was provided.

An email was received from Buffy McQuillen, Tribal Historic Preservation Officer for the Federated Indians of Graton Rancheria, on May 26, 2020. Ms. McQuillen stated that the study area is within their ancestral territory and they would like to be provided with the results of our research efforts and recommendations.

An email was received from Brenda Tomaras, representative of the Lytton Rancheria of California, on June 11, 2020. Ms. Tomaras stated that the tribe has no specific information but believes that the study

area falls within their traditional Pomo territory. She stated the tribe will be consulting with the appropriate lead agency regarding this project.

No other comments have been received as of the date of this report. A log of contact efforts is appended to this report, along with copies of correspondence (see Appendix A).

Archival Research Procedures

Archival research included examination of the library and project files at Tom Origer & Associates. This research is meant to assess the potential to encounter archaeological sites and built environment within the study area. Research was also completed to determine the potential for buried archaeological deposits.

A review (NWIC File No. 19-2058) was completed of the archaeological site base maps and records, survey reports, and other materials on file at the Northwest Information Center (NWIC), Sonoma State University, Rohnert Park. Sources of information included but were not limited to the current listings of properties on the National Register of Historic Places, California Historical Landmarks, California Register of Historical Resources, and California Points of Historical Interest as listed in the OHP's *Historic Property Directory* (2012) and the *Built Environment Resources Directory* (2019).

The OHP has determined that structures in excess of 45 years of age could be important historical resources, and former building and structure locations could be important archaeological sites. Archival research included an examination of 19th and 20th-century maps and aerial photographs to gain insight into the nature and extent of historical development in the general vicinity, and especially within the study area.

Ethnographic literature that describes appropriate Native American groups, county histories, and other primary and secondary sources were reviewed. Sources reviewed are listed in the "Materials Consulted" section of this report.

A model for predicting a location's sensitivity for buried archaeological sites was formulated by Byrd *et al.* (2017) based on the age of the landform, slope, and proximity to water. A location is considered to have the highest sensitivity if the landform dates to the Holocene, has a slope of five percent or less, is within 150 meters of freshwater, and 150 meters of a confluence. Note, the Holocene Epoch is the current period of geologic time, which began about 11,700 years ago, and coincides with the emergence of human occupation of the area. A basic premise of the model is that archaeological deposits will not be buried within landforms that predate human colonization of the area. Calculating these factors using the buried site model (Byrd *et al.* 2017:Tables 11 and 12), a location's sensitivity is scored on a scale of 1 to 10 and classed as follows: lowest (<1); low (1-3); moderate (3-5.5); high (5.5-7.5); highest (>7.5). Incorporating King's (2004) analysis of buried site potential, the probability of encountering buried archaeological deposits for each class is as follows:

<u>Sensitivity Score</u> ¹	<u>Classification</u> ¹	<u>Probability</u> ²
<1	Lowest	<1 %
1-3	Low	1-2 %
3-5.5	Moderate	2-3%
5.5-7.5	High	3-5%
>7.5	Highest	5-20%

¹ Byrd *et al.* 2017

² King 2004

Archival Research Findings

Archival research found that the study area had not been subjected to a cultural resources survey; though, it had been included in two studies (Archaeological Consulting and Research Services, Inc. 1975; Bloomfield 1989). Six studies have been conducted within a quarter-mile of the study area (Table 2). One site has been recorded within a quarter-mile of the study area and it is located approximately 1,325 feet away (White and Mikkelsen 1982).

Table 2. Studies within a Quarter-mile of the Study Area

Author	Date	S#
Beard	2007	34323
Garcia and Associates	2004	31737
IFC International	2014	45663
Origer	1990	13217
Steen and Origer	2005	31221
White and Fredrickson	1982	2845

There are no reported ethnographic sites within one mile of the study area (Barrett 1908).

A review of 19th and 20th-century maps shows a building within the study area as early as 1968 (Bowers 1867; GLO 1862; Reynolds and Proctor 1898; Thompson 1877; USGS 1916, 1944, 1954a, 1954b, 1968). Review of aerial photos shows that the house was demolished and removed between 1993 and 2004.

Based on landform age, our analysis of the environmental setting, and incorporating Meyer and Kaijankoski (2017) analysis of sensitivity for buried sites shows that there is a moderate potential (3.3) for buried archaeological site indicators.

Field Survey Procedures

An intensive field survey was completed by Eileen Barrow on June 29, 2020. One hour was spent in the field and field conditions were sunny and warm. Surface examination consisted of walking in 15-meter transects and hoes were used as needed to expose the ground surface. Ground visibility for most of the study area was poor with vegetation being the primary hindrance.

Field Survey Findings

Archaeology

Field survey of the study area found no archaeological site indicators.

Built Environment

There are no buildings or structures within the study area.

DISCUSSION AND RECOMMENDATIONS

No archaeological site indicators were found within the study area. Application of the buried sites model indicates a moderate potential for buried resources. There are no buildings or structures within the study area.

Archaeological Recommendations

No recommendations are warranted.

Built Environment Recommendations

No recommendations are warranted.

Accidental Discovery

In keeping with the CEQA guidelines, if archaeological remains are uncovered, work at the place of discovery should be halted immediately until a qualified archaeologist can evaluate the finds (§15064.5 [f]). Prehistoric archaeological site indicators include: obsidian and chert flakes and chipped stone tools; grinding and mashing implements (e.g., slabs and handstones, and mortars and pestles); bedrock outcrops and boulders with mortar cups; and locally darkened midden soils. Midden soils may contain a combination of any of the previously listed items with the possible addition of bone and shell remains and fire-affected stones. Historic period site indicators generally include: fragments of glass, ceramic, and metal objects; milled and split lumber; and structure and feature remains such as building foundations and discrete trash deposits (e.g., wells, privy pits, dumps).

The following actions are promulgated in the CEQA Guidelines Section 15064.5(d) and pertain to the discovery of human remains. If human remains are encountered, excavation or disturbance of the location must be halted in the vicinity of the find, and the county coroner contacted. If the coroner determines the remains are Native American, the coroner will contact the NAHC. The NAHC will identify the person or persons believed to be most likely descended from the deceased Native American. The most likely descendent makes recommendations regarding the treatment of the remains with appropriate dignity.

SUMMARY

Tom Origer & Associates completed a cultural resources study of the property at 1650 West Steele Lane, Santa Rosa, Sonoma County, California. The study was requested and authorized by J. Kapolchok & Associates on behalf of Patrick O'Neill. This study was conducted in compliance with the requirements of the City of Santa Rosa and those of the CEQA. No cultural resources were found during the course of this study. Documentation pertaining to this study is on file at Tom Origer & Associates (File No. 2020-027).

MATERIALS CONSULTED

- Archaeological Consulting and Research Services, Inc.
1975 *Preliminary Archaeological Assessment for the Coddington Environmental Impact Report, Santa Rosa, California*. Document S-955 on file at the Northwest Information Center, Sonoma State University, Rohnert Park.
- Barbour, M. and J. Major, ed.
1988 *Terrestrial Vegetation of California*. California Native Plant Society.
- Barrett, S.
1908 *The Ethno-Geography of the Pomo and Neighboring Indians*. University of California Publications in American Archaeology and Ethnology Vol. 6, No. 1:1-322. University of California Press, Berkeley.
- Beard, V.
2007 *A Cultural Resources Survey of the Carlton Homes Property at 2564 Hardies Lane, Santa Rosa, Sonoma County, California*. Document S-34323 on file at the Northwest Information Center, Sonoma State University, Rohnert Park.
- Beardsley, R.
1948 Culture Sequences in Central California Archaeology. In *American Antiquity* Vol. 14, No. 1, pp. 1-28.
1954 *Temporal and Areal Relationships in Central California Archaeology*. Reports of the University of California Archaeological Survey 24-25. Berkeley, California.
- Bell and Heymans
1888 *Map of Sonoma County, California*. Bell and Heymans, San Francisco.
- Bloomfield, A.
1989 *Cultural Heritage Survey of the City of Santa Rosa, California*. Document S-48798 on file at the Northwest Information Center, Sonoma State University, Rohnert Park.
- Bowers, A.
1867 *Map of Sonoma County, California*. 2nd ed. A. Bowers.
- Byrd, B., A. Whitaker, P. Mikkelsen, and J. Rosenthal
2017 *San Francisco Bay-Delta Region Context and Research Design for Native American Archaeological Resources Caltrans District 4*. On file at the Caltrans District 04 Office of Cultural Resource Studies, Oakland, California.
- Byrd, B., A. Whitaker, P. Mikkelsen, J. Rosenthal, J. Meyer, and P. Kaijankoski
2017 Discovering Sites: Geoarchaeological Approaches to Site Sensitivity and Predictive Modeling. In, *San Francisco Bay-Delta Region Context and Research Design for Native American Archaeological Resources Caltrans District 4*. B. Byrd, A. Whitaker, P. Mikkelsen, and J. Rosenthal. Pp 4-1 through 4-13. On file at the Caltrans District 04 Office of Cultural Resource Studies, Oakland, California.
- Department of Parks and Recreation
1976 *California Inventory of Historical Resources*. State of California, Sacramento.

Erlandson, J., T. Rick, T. Jones, and J. Porcasi

2007 One if by Land, Two if by Sea: Who Were the First Californians? In: *California Prehistory: Colonization, Culture, and Complexity*. (pp 53-62) T. Jones and K. Klar, editors. AltaMira Press. Lanham, MD.

Fredrickson, D.

1973 *Early Cultures of the North Coast Ranges, California*. Ph.D. dissertation. Department of Anthropology, University of California, Davis.

1984 The North Coastal Region. In *California Archaeology*, edited by M. Moratto. Academic Press, San Francisco.

Garcia and Associates

2004 *Archaeological Resources Technical Report for the Sonoma Marin Area Rail Transit (SMART) Project, Sonoma and Marin Counties, California*. Document S-31737 on file at the Northwest Information Center, Sonoma State University, Rohnert Park.

General Land Office (GLO)

1862 *Plat of the Rancho San Miguel (West)*. Department of the Interior, Washington, D.C.

Golla, V.

2007 Linguistic Prehistory. In *California Prehistory: Colonization, Culture, and Complexity* edited by T. Jones and K. Klar, pp. 71-82. Alta Mira Press, Lanham, Maryland.

Groza, R.

2002 An AMS Chronology for Central California *Olivella* Shell Beads. Master's thesis, Department of Anthropology, San Francisco State University, San Francisco, California.

Groza, R., J. Rosenthal, J. Southon, and R. Milliken

2011 A Refined Shell Bead Chronology for Late Holocene Central California. *Journal of California and Great Basin Anthropology* 31(2):13-32.

Heizer, R. and F. Fenenga

1939 Archaeological Horizons in Central California. *American Anthropologist*, Vol. 41, pp. 378-399.

Hoover, M., H. Rensch, E. Rensch, and W. Abeloe

1966 *Historic Spots in California*. 3rd edition. Stanford University Press, Stanford.

Hoover, M., H. Rensch, E. Rensch, W. Abeloe, and D. Kyle

1990 *Historic Spots in California*. 4th edition. Stanford University Press, Stanford.

2002 *Historic Spots in California*. 5th edition. Stanford University Press, Stanford.

ICF International

2014 *Draft Cultural Resources Inventory and Evaluation Report for Sonoma-Marin Area Rail Transit (SMART):IOS-1B and Operations and Maintenance Facility Site, Santa Rosa, Sonoma County (MP 55.2-MP 59.9)*. Document S-45663 on file at the Northwest Information Center, Sonoma State University, Rohnert Park.

- Kniffen, F.
1939 *Pomo Geography*. University of California Publications in American Archaeology and Ethnology, Vol. 36. Berkeley.
- Kroeber, A.
1925 *Handbook of the Indians of California*. Bureau of American Ethnology, Bulletin 78, Smithsonian Institution, Washington, D.C.
- Lillard, J., R. Heizer, and F. Fenenga
1939 *An Introduction to the Archaeology of Central California*. Sacramento Junior College Department of Anthropology, Bulletin 2, pp. 93, figs. 20 and map, pls. 31).
- McIntire and Lewis
1908 *Official Map of the County of Sonoma, California*. County of Sonoma, Santa Rosa.
- McLaughlin, R., V. Langenheim, A. Sarna-Wojcicki, R. Fleck, D. McPhee, C. Roberts, C. McCabe, and E. Wan
2008 *Geologic and Geophysical Framework of the Santa Rosa 7.5' Quadrangle, Sonoma County, California*. Department of the Interior. Geological Survey. Washington, D.C.
- McLaughlin, R., D. Wagner, A. Sarna Wojcicki
2003 *Field Trip Guide: Geology of the Right Stepover Region between the Rodgers Creek, Healdsburg, and Maacama Faults*. Northern California Geological Society, San Francisco.
- McLendon, S. and R. Oswalt
1978 Pomo: Introduction. In *California*, edited by R. Heizer, pp. 274-288. Handbook of North American Indians, Vol. 8, W. Sturtevant, general editor. Smithsonian Institution, Washington, D.C.
- Meighan, C.
1955 *Archaeology of the North Coast Ranges, California*. Reports of the University of California Archaeological Survey No. 30. University of California, Berkeley.
- Meyer, J. and J. Rosenthal
2007 *Geoarchaeological Overview of the Nine Bay Area Counties in Caltrans District 4*. Document S-33600 on file at the Northwest Information Center, Sonoma State University, Rohnert Park.
- Miller, V.
1972 *Soil Survey of Sonoma County, California*. U.S. Department of Agriculture in cooperation with the University of California Agricultural Experiment Station.
- Milliken, R., R. Fitzgerald, M. Hylkema, R. Groza, T. Origer, D. Bieling, A. Leventhal, R. Wiberg, A. Gottsfield, D. Gillette, V. Bellifemine, E. Strother, R. Cartier, and D. Fredrickson
2007 Punctuated Cultural Change in the San Francisco Bay Area. In *California Prehistory: Colonization, Culture, and Complexity*, edited by Terry L. Jones and Kathryn Klar, pp. 99-124. Altamira Press, Walnut Creek, California.
- Moratto, M.
1984 *California Archaeology*. Academic Press, San Francisco.

- Munz, P. and D. Keck
1973 *A California Flora and Supplement*. University of California Press, Berkeley.
- Nelson, N.
1909 *Shellmounds of the San Francisco Bay Region*. University of California Publications in American Archaeology and Ethnology 7(4). Berkeley.
- Office of Historic Preservation (OHP)
1995 *Instructions for Recording Historical Resources*. California Office of Historic Preservation, Sacramento.
2012 *Historic Property Directory*. Office of Historic Preservation, Sacramento.
- Origer, T.
1987 *Temporal Control in the Southern North Coast Ranges of California: The Application of Obsidian Hydration Analysis*. Papers in Northern California Anthropology, Number 1, Berkeley.
1990 *An Archaeological Survey for the AT&T Fiber Optics Cable, San Francisco to Point Arena, California*. Document S-13217 on file at the Northwest Information Center, Sonoma State University, Rohnert Park.
- Peugh, E.
1934 *Map of Sonoma County, California*. E.A. Peugh, Santa Rosa.
- Reynolds, W. and T. Proctor
1898 *Illustrated Atlas of Sonoma County, California*. Reynolds and Proctor, Santa Rosa.
- Steen, E. and T. Origer
2005 *A Cultural Resources Survey of Two Parcels APNs (041-021-052 and 041-021-053), Located on West Steele Lane, Santa Rosa, Sonoma County, California*. Document S-31221 on file at the Northwest Information Center, Sonoma State University, Rohnert Park.
- State of California Department of Finance.
2011 *Historical Census Populations of Counties and Incorporated Cities in California, 1850–2010*. <http://www.dof.ca.gov/research/demographic/state_census_data_center/historical_census_1850-2010/>
- Thompson, R.
1884 *Map of Sonoma County, California: Showing New Boundary Lines of County and Townships, Private Claims and Ranches, Government Townships and Section Lines, Rail Roads and Public Roads, Water Works, Cities, Towns, School Districts, etc.*
- Thompson, T.H. & Co.
1877 *Historical Atlas Map of Sonoma County, California*. T.H. Thompson & Co., Oakland.
- United States Geological Survey (USGS)
1916 *Santa Rosa, California 15' map*. Geological Survey, Washington, D.C.
1944 *Santa Rosa, California 15' map*. Geological Survey, Washington, D.C.

1954a Santa Rosa, California 15' map. Geological Survey, Washington, D.C.

1954b Santa Rosa, California 7.5' map. Geological Survey, Washington, D.C.

1968 Santa Rosa, California 7.5' map. Geological Survey, Washington, D.C.

1973 Santa Rosa, California 7.5' map. Geological Survey, Washington, D.C.

1980 Santa Rosa, California 7.5' map. Geological Survey, Washington, D.C.

1994 Santa Rosa, California 7.5' map. Geological Survey, Washington, D.C.

White, G. and D. Fredrickson

1982 *An Archaeological Survey of the 16.1-Acre Qantas Development Corporation Range Avenue Condominium Project, Range Avenue, Santa Rosa, Sonoma County, California.* Document S-2845 on file at the Northwest Information Center, Sonoma State University, Rohnert Park.

White, G. and P. Mikkelsen

1982 Archaeological Site Record for P-49-002122 (CA-SON-1384). Document on file at the Northwest Information Center, Sonoma State University, Rohnert Park.

APPENDIX A

Native American Contact

Copies of Correspondence

Native American Contact Efforts
1650 West Steele Lane
Santa Rosa, Sonoma, Sonoma County

Organization	Contact	Action	Results
Native American Heritage Commission		Letter 5/27/20	The NAHC replied with a letter dated May 29, 2020, which indicated that the Sacred Lands File has no information about the presence of Native American cultural resources in the immediate project area. A list of additional contacts was provided.
Cloverdale Rancheria of Pomo Indians of California	Patricia Hermosillo	Letter 5/22/20	No response has been received as of the date of this report.
Dry Creek Rancheria Band of Pomo Indians	Chris Wright	Letter 5/22/20	No response has been received as of the date of this report.
Federated Indians of Graton Rancheria	Gene Buvelot Buffy McQuillen Greg Sarris	Letter 5/22/20	An email was received from Buffy McQuillen, Tribal Historic Preservation Officer for the Federated Indians of Graton Rancheria, on May 26, 2020. Ms. McQuillen stated that the study area is within their ancestral territory and they would like to be provided with the results of our research efforts and recommendations.
Guidiville Band of Pomo Indians	Merlene Sanchez	Letter 5/22/20	No response has been received as of the date of this report.
Kashia Band of Pomo Indians of the Stewarts Point Rancheria	Dino Franklin, Jr.	Letter 5/22/20	No response has been received as of the date of this report.
Lytton Band of Pomo Indians	Marjorie Mejia	Letter 5/22/20	An email was received from Brenda Tomaras, representative of the Lytton Rancheria of California, on June 11, 2020. Ms. Tomaras stated that the tribe has no specific information but believes that the study area falls within their traditional Pomo territory. She stated the tribe will be consulting with the appropriate lead agency regarding this project.
Middletown Rancheria of Pomo Indians of California	Jose Simon, III	Letter 5/22/20	No response has been received as of the date of this report.
Mishewal-Wappo Tribe of Alexander Valley	Gabaldon	Letter 5/22/20	No response has been received as of the date of this report.

Sacred Lands File & Native American Contacts List Request

NATIVE AMERICAN HERITAGE COMMISSION

1550 Harbor Blvd., Suite 100
West Sacramento, CA 95691
(916) 373-3710
(916) 373-5471 – Fax
nahc@nahc.ca.gov

Information Below is Required for a Sacred Lands File Search

Project: 1650 W. Steele Lane
County: Sonoma

USGS Quadrangles

Name: Santa Rosa

Township T7N Range R8W Section(s) MDBM (within the San Miguel (West) land grant)

Date: May 27, 2020

Company/Firm/Agency: Tom Origer & Associates

Contact Person: Eileen Barrow

Address: P.O. Box 1531

City: Rohnert Park

Zip: 94927

Phone: (707) 584-8200

Fax: (707) 584-8300

Email: eileen@origer.com

Project Description: The project proponent is obtaining permits from the City of Santa Rosa to develop the 0.98-acre property into multi-family housing.

NATIVE AMERICAN HERITAGE COMMISSION

May 29, 2020

Eileen Barrow, Senior Associate
Tom Origer & Associates

Via Email to: Eileen@origer.com

Re: 1650 W. Steele Lane Project, Sonoma County

Dear Ms. Barrow:

A record search of the Native American Heritage Commission (NAHC) Sacred Lands File (SLF) was completed for the information you have submitted for the above referenced project. The results were negative. However, the absence of specific site information in the SLF does not indicate the absence of cultural resources in any project area. Other sources of cultural resources should also be contacted for information regarding known and recorded sites.

Attached is a list of Native American tribes who may also have knowledge of cultural resources in the project area. This list should provide a starting place in locating areas of potential adverse impact within the proposed project area. I suggest you contact all of those indicated; if they cannot supply information, they might recommend others with specific knowledge. By contacting all those listed, your organization will be better able to respond to claims of failure to consult with the appropriate tribe. If a response has not been received within two weeks of notification, the Commission requests that you follow-up with a telephone call or email to ensure that the project information has been received.

If you receive notification of change of addresses and phone numbers from tribes, please notify me. With your assistance, we can assure that our lists contain current information.

If you have any questions or need additional information, please contact me at my email address: Sarah.Fonseca@nahc.ca.gov.

Sincerely,



Sarah Fonseca
Cultural Resources Analyst

Attachment



CHAIRPERSON
Laura Miranda
Luiseño

VICE CHAIRPERSON
Reginald Pagaling
Chumash

SECRETARY
Merri Lopez-Keifer
Luiseño

PARLIAMENTARIAN
Russell Attebery
Karuk

COMMISSIONER
Marshall McKay
Wintun

COMMISSIONER
William Mungary
Paiute/White Mountain
Apache

COMMISSIONER
Julie Tumamait-Stenslie
Chumash

COMMISSIONER
[Vacant]

COMMISSIONER
[Vacant]

EXECUTIVE SECRETARY
Christina Snider
Pomo

NAHC HEADQUARTERS
1550 Harbor Boulevard
Suite 100
West Sacramento,
California 95691
(916) 373-3710
nahc@nahc.ca.gov
NAHC.ca.gov

**Native American Heritage Commission
Native American Contact List
Sonoma County
5/29/2020**

Cloverdale Rancheria of Pomo Indians

Patricia Hermosillo, Chairperson
555 S. Cloverdale Blvd., Suite A Pomo
Cloverdale, CA, 95425
Phone: (707) 894 - 5775
Fax: (707) 894-5727
info@cloverdalerancheria.com

Kashia Band of Pomo Indians of the Stewarts Point Rancheria

Loren Smith, Tribal Historic Preservation Officer
1420 Guerneville Road, Ste 1 Pomo
Santa Rosa, CA, 95403
Phone: (707) 591 - 0580
Fax: (707) 591-0583

Dry Creek Rancheria of Pomo Indians

Chris Wright, Chairperson
P.O. Box 607 Pomo
Geyserville, CA, 95441
Phone: (707) 814 - 4150
lynnl@drycreekrancheria.com

Lytton Rancheria

Marjorie Mejia, Chairperson
437 Aviation Boulevard Pomo
Santa Rosa, CA, 95403
Phone: (707) 575 - 5917
Fax: (707) 575-6974
margiemejia@aol.com

Federated Indians of Graton Rancheria

Greg Sarris, Chairperson
6400 Redwood Drive, Ste 300 Coast Miwok
Rohnert Park, CA, 94928 Pomo
Phone: (707) 566 - 2288
Fax: (707) 566-2291
gbuvelot@gratonrancheria.com

Middletown Rancheria of Pomo Indians

Jose Simon, Chairperson
P.O. Box 1035 Lake Miwok
Middletown, CA, 95461 Pomo
Phone: (707) 987 - 3670
Fax: (707) 987-9091
sshope@middletownrancheria.com

Guidiville Indian Rancheria

Merlene Sanchez, Chairperson
P.O. Box 339 Pomo
Talmage, CA, 95481
Phone: (707) 462 - 3682
Fax: (707) 462-9183
admin@guidiville.net

Middletown Rancheria

Sally Peterson, THPO
P.O. Box 1658 Lake Miwok
Middletown, CA, 95461 Pomo
Phone: (707) 987 - 3670
THPO@middletownrancheria.com

Kashia Band of Pomo Indians of the Stewarts Point Rancheria

Dino Franklin, Chairperson
1420 Guerneville Road, Ste 1 Pomo
Santa Rosa, CA, 95403
Phone: (707) 591 - 0580
Fax: (707) 591-0583
dino@stewartspoint.org

Mishewal-Wappo Tribe of Alexander Valley

Scott Gabaldon, Chairperson
2275 Silk Road Wappo
Windsor, CA, 95492
Phone: (707) 494 - 9159
scottg@mishewalwappotribe.com

This list is current only as of the date of this document. Distribution of this list does not relieve any person of statutory responsibility as defined in Section 7050.5 of the Health and Safety Code, Section 5097.94 of the Public Resource Section 5097.98 of the Public Resources Code.

This list is only applicable for contacting local Native Americans with regard to cultural resources assessment for the proposed 1650 W. Steele Lane Project, Sonoma County.

Tom Origer & Associates

Archaeology / Historical Research

May 22, 2020

Patricia Hermosillo
Cloverdale Rancheria of Pomo Indians of California
555 South Cloverdale Blvd., Suite A
Cloverdale, CA 95425

RE: 1650 W. Steele Lane, Santa Rosa, Sonoma County

Dear Ms. Hermosillo:

I am writing to notify you of a proposed project within the County of Sonoma, for which our firm is conducting a cultural resources study. project proponent is seeking a permit from the City of Santa Rosa to construct a 36-unit apartment complex within the city limits. The entire parcel is approximately 0.98 acres in size. The City of Santa Rosa is reviewing the project for California Environmental Quality Act compliance.

This letter serves as notification of our study and does not constitute consultation.

Enclosed is a portion of the Santa Rosa, Calif. 7.5' USGS topographic quadrangle showing the project location.

Sincerely,



Eileen Barrow
Senior Associate

Tom Origer & Associates

Archaeology / Historical Research

May 22, 2020

Chris Wright
Dry Creek Rancheria Band of Pomo Indians
P.O. Box 607
Geyserville, CA 95441

RE: 1650 W. Steele Lane, Santa Rosa, Sonoma County

Dear Mr. Wright:

I am writing to notify you of a proposed project within the County of Sonoma, for which our firm is conducting a cultural resources study. The project proponent is seeking a permit from the City of Santa Rosa to construct a 36-unit apartment complex within the city limits. The entire parcel is approximately 0.98 acres in size. The City of Santa Rosa is reviewing the project for California Environmental Quality Act compliance.

This letter serves as notification of the project and does not constitute consultation.

Enclosed is a portion of the Santa Rosa, Calif. 7.5' USGS topographic quadrangle showing the project location.

Sincerely,



Eileen Barrow
Senior Associate

Tom Origer & Associates

Archaeology / Historical Research

May 22, 2020

Gene Buvelot
Federated Indians of Graton Rancheria
6400 Redwood Drive, Ste. 300
Rohnert Park, CA 94928

RE: 1650 W. Steele Lane, Santa Rosa, Sonoma County

Dear Mr. Buvelot:

I am writing to notify you of a proposed project within the County of Sonoma, for which our firm is conducting a cultural resources study. project proponent is seeking a permit from the City of Santa Rosa to construct a 36-unit apartment complex within the city limits. The entire parcel is approximately 0.98 acres in size. The City of Santa Rosa is reviewing the project for California Environmental Quality Act compliance.

This letter serves as notification of our study and does not constitute consultation.

Enclosed is a portion of the Santa Rosa, Calif. 7.5' USGS topographic quadrangle showing the project location.

Sincerely,



Eileen Barrow
Senior Associate

Tom Origer & Associates

Archaeology / Historical Research

May 22, 2020

Buffy McQuillen
Federated Indians of Graton Rancheria
6400 Redwood Drive, Ste. 300
Rohnert Park, CA 94928

RE: 1650 W. Steele Lane, Santa Rosa, Sonoma County

Dear Ms. McQuillen:

I am writing to notify you of a proposed project within the County of Sonoma, for which our firm is conducting a cultural resources study. project proponent is seeking a permit from the City of Santa Rosa to construct a 36-unit apartment complex within the city limits. The entire parcel is approximately 0.98 acres in size. The City of Santa Rosa is reviewing the project for California Environmental Quality Act compliance.

This letter serves as notification of our study and does not constitute consultation.

Enclosed is a portion of the Santa Rosa, Calif. 7.5' USGS topographic quadrangle showing the project location.

Sincerely,



Eileen Barrow
Senior Associate

Tom Origer & Associates

Archaeology / Historical Research

May 22, 2020

Greg Sarris
Federated Indians of Graton Rancheria
6400 Redwood Drive, Ste. 300
Rohnert Park, CA 94928

RE: 1650 W. Steele Lane, Santa Rosa, Sonoma County

Dear Mr. Sarris:

I am writing to notify you of a proposed project within the County of Sonoma, for which our firm is conducting a cultural resources study. project proponent is seeking a permit from the City of Santa Rosa to construct a 36-unit apartment complex within the city limits. The entire parcel is approximately 0.98 acres in size. The City of Santa Rosa is reviewing the project for California Environmental Quality Act compliance.

This letter serves as notification of our study and does not constitute consultation.

Enclosed is a portion of the Santa Rosa, Calif. 7.5' USGS topographic quadrangle showing the project location.

Sincerely,



Eileen Barrow
Senior Associate

Tom Origer & Associates

Archaeology / Historical Research

May 22, 2020

Merlene Sanchez
Guidiville Band of Pomo Indians
P.O. Box 339
Talmage, CA 95481

RE: 1650 W. Steele Lane, Santa Rosa, Sonoma County

Dear Ms. Sanchez:

I am writing to notify you of a proposed project within the County of Sonoma, for which our firm is conducting a cultural resources study. project proponent is seeking a permit from the City of Santa Rosa to construct a 36-unit apartment complex within the city limits. The entire parcel is approximately 0.98 acres in size. The City of Santa Rosa is reviewing the project for California Environmental Quality Act compliance.

This letter serves as notification of our study and does not constitute consultation.

Enclosed is a portion of the Santa Rosa, Calif. 7.5' USGS topographic quadrangle showing the project location.

Sincerely,



Eileen Barrow
Senior Associate

Tom Origer & Associates

Archaeology / Historical Research

May 22, 2020

Dino Franklin
Kashia Band of Pomo Indians of the Stewarts Point Rancheria
1420 Guerneville Rd., Suite 1
Santa Rosa, CA 95403

RE: 1650 W. Steele Lane, Santa Rosa, Sonoma County

Dear Mr. Franklin:

I am writing to notify you of a proposed project within the County of Sonoma, for which our firm is conducting a cultural resources study. project proponent is seeking a permit from the City of Santa Rosa to construct a 36-unit apartment complex within the city limits. The entire parcel is approximately 0.98 acres in size. The City of Santa Rosa is reviewing the project for California Environmental Quality Act compliance.

This letter serves as notification of our study and does not constitute consultation.

Enclosed is a portion of the Santa Rosa, Calif. 7.5' USGS topographic quadrangle showing the project location.

Sincerely,



Eileen Barrow
Senior Associate

Tom Origer & Associates

Archaeology / Historical Research

May 22, 2020

Marjorie Mejia
Lytton Rancheria of California
437 Aviation Blvd.
Santa Rosa, CA 95403

RE: 1650 W. Steele Lane, Santa Rosa, Sonoma County

Dear Ms. Mejia:

I am writing to notify you of a proposed project within the County of Sonoma, for which our firm is conducting a cultural resources study. project proponent is seeking a permit from the City of Santa Rosa to construct a 36-unit apartment complex within the city limits. The entire parcel is approximately 0.98 acres in size. The City of Santa Rosa is reviewing the project for California Environmental Quality Act compliance.

This letter serves as notification of our study and does not constitute consultation.

Enclosed is a portion of the Santa Rosa, Calif. 7.5' USGS topographic quadrangle showing the project location.

Sincerely,



Eileen Barrow
Senior Associate

Tom Origer & Associates

Archaeology / Historical Research

May 22, 2020

Jose Simon III
Middletown Rancheria of Pomo Indians of California
P.O. Box 1035
Middletown, CA 95461

RE: 1650 W. Steele Lane, Santa Rosa, Sonoma County

Dear Mr. Simon:

I am writing to notify you of a proposed project within the County of Sonoma, for which our firm is conducting a cultural resources study. project proponent is seeking a permit from the City of Santa Rosa to construct a 36-unit apartment complex within the city limits. The entire parcel is approximately 0.98 acres in size. The City of Santa Rosa is reviewing the project for California Environmental Quality Act compliance.

This letter serves as notification of our study and does not constitute consultation.

Enclosed is a portion of the Santa Rosa, Calif. 7.5' USGS topographic quadrangle showing the project location.

Sincerely,



Eileen Barrow
Senior Associate

Tom Origer & Associates

Archaeology / Historical Research

May 22, 2020

Scott Gabaldon
Mishewal-Wappo Tribe of Alexander Valley
2275 Silk Road
Windsor, CA 95492

RE: 1650 W. Steele Lane, Santa Rosa, Sonoma County

Dear Mr. Gabaldon:

I am writing to notify you of a proposed project within the County of Sonoma, for which our firm is conducting a cultural resources study. project proponent is seeking a permit from the City of Santa Rosa to construct a 36-unit apartment complex within the city limits. The entire parcel is approximately 0.98 acres in size. The City of Santa Rosa is reviewing the project for California Environmental Quality Act compliance.

This letter serves as notification of our study and does not constitute consultation.

Enclosed is a portion of the Santa Rosa, Calif. 7.5' USGS topographic quadrangle showing the project location.

Sincerely,



Eileen Barrow
Senior Associate

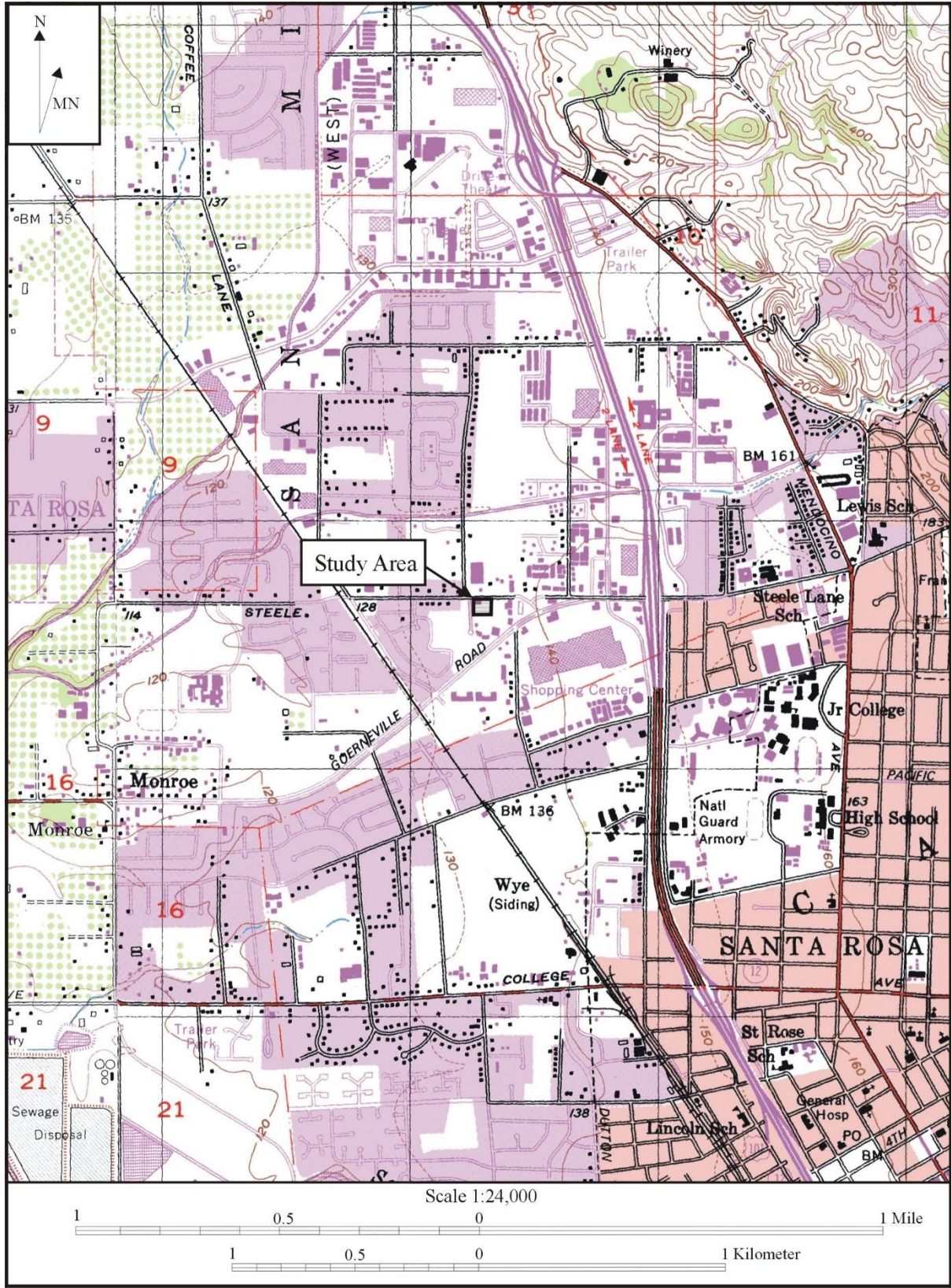

Eileen

From: THPO@gratonrancheria.com
Sent: Tuesday, May 26, 2020 4:30 PM
To: 'Eileen Barrow (Eileen@origer.com)'
Subject: 1650 W. Steele Lane, Santa Rosa

Dear Eileen,

Thank you for your outreach and request for identification of cultural resources from the Federated Indians of Graton Rancheria. The project area identified in your correspondence is within the Tribe's ancestral territory and there may be tribal cultural resource impacts. Please provide the Tribe with the results of your research efforts and recommendations. The information can be emailed or mailed to the following address.

Buffy McQuillen
Tribal Heritage Preservation Officer (THPO) Native American Graves Protection and Repatriation Act (NAGPRA)
Office: 707.566.2288; ext. 137
Cell: 707.318.0485
FAX: 707.566.2291

Hector Garcia Cabrales
THPO Administrative Assistant II
Federated Indians of Graton Rancheria
6400 Redwood Drive, Suite 300
Rohnert Park, CA 94928
Office: 707.566.2288, ext. 138
Fax: 707.588-9809
Email: hgarcia@gratonrancheria.com<mailto:hgarcia@gratonrancheria.com>
www.gratonrancheria.com<http://www.gratonrancheria.com/>

P please consider our environment before printing this email.

Federated Indians of Graton Rancheria: Proprietary and Confidential Confidentiality Notice: This transmittal is a confidential communication or may otherwise be privileged. If you are not the intended recipient, you are hereby notified that you have received this transmittal in error and that any review, dissemination, distribution or copying of this transmittal is strictly prohibited. If you have received this communication in error, please notify this office and immediately delete this message and all its attachments, if any.

Eileen

From: Brenda L. Tomaras <btomaras@mtowlaw.com>
Sent: Thursday, June 11, 2020 11:05 AM
To: Eileen
Subject: Lytton Rancheria Scoping Response for 1650 W. Steele Lane

Good Morning Eileen,

Thank you for the letter regarding the above-referenced project. While the Tribe has no specific information which it could provide to you for inclusion in your reports, it believes that the project land falls within traditional Pomo territory and that there is a potential for finding tribal cultural resources on the project site. The Lytton Rancheria is interested in the protection and preservation of Pomo artifacts and sites and believes that such cultural resources may be encountered during the project.

The Tribe will be consulting further on the project with the appropriate lead agency and will get a copy of the survey once completed. We would ask that in your report you note all resources (flakes, isolates, etc.) even if they may not reach a level of significance under CEQA.

Thank you.

Brenda L. Tomaras
Tomaras & Ogas, LLP
10755-F Scripps Poway Parkway #281
San Diego, CA 92131
(858) 554-0550
(858) 777-5765 Facsimile

CONFIDENTIALITY NOTICE: This e-mail transmission, and any documents, files or previous e-mail messages attached to it is confidential and may be legally privileged. If you are not the intended recipient or authorized agent for the intended recipient, you have received this message and attachments in error, and any review, dissemination, or reproduction is strictly prohibited. If you are not the intended recipient, please immediately notify us by reply e-mail or by telephone at (858) 554-0550, and destroy the original transmission and its attachments without reading them or saving them. Failure to follow this process may be unlawful.

January 3, 2019
Job No. 3674.0

O'Neill Construction, Inc.
Attention: Mr. Patrick O'Neill
16 Leona Drive
San Rafael, CA 9490

Report
Geotechnical Investigation
1650 West Steele Lane Apartments
A.P.N. 041-042-012
Santa Rosa, California

This report presents the results of our geotechnical investigation for the subject project. The parcel is shown on the Test Hole Location Plan, Plate 1.

We understand that the one-acre parcel will be developed with a series of three-story, wood framed apartment buildings with slab-on-grade ground floors. Associated improvements will include covered parking structures, asphalt paved parking and driveway areas. Foundation loads are typical for the type of construction indicated. Unretained cuts and fills will less than about 2 feet high. No retaining walls are anticipated.

The scope of our investigation, as outlined in our October 23, 2019, agreement included reviewing selected published geologic information from our files, exploring subsurface conditions at the site, and performing laboratory testing on selected samples. Based upon our work, we have developed conclusions and recommendations concerning:

1. Proximity of the site to published active faults.
2. Soil/rock and ground water conditions observed.
3. Site preparation and grading.
4. Foundation type(s) and design criteria.
5. Concrete slabs-on-grade.

Westside Center
6470 Mirabel Road
Post Office Box 460
Forestville, CA 95436
707.887.2505

1650 West Steele Lane
Job No. 3674.0
January 3, 2020
Page 2

6. Pavement thickness.
7. Geotechnical engineering drainage.
8. Supplemental services.

Our scope of work did not include an evaluation of any potential hazardous waste contamination or corrosion potential of the soil or groundwater at the site. Further, our scope of work did not include evaluating areas beyond the described improvement areas or off site improvements.

WORK PERFORMED

We reviewed the following selected geotechnical data:

California Geological Survey, 2018, revision, Earthquake Fault Zones, A Guide for Government Agencies, Property Owners/Developers, and Geoscience Practitioners for Assessing Fault Rupture Hazards in California: Special Publication 42,
https://www.conservation.ca.gov/cgs/Documents/Publications/SP_042.pdf

California's Office of Statewide Health Planning and Development (OSHPD), Seismic Design Maps Web Application, 2019, <https://seismicmaps.org>

California Building Code, 2016, California Building Standard Commission.

Environmental Geology Services, 2009, Report Additional Investigation of Soil, Soil Vapor, and Shallow and Deeper Groundwater, Boomer's Fabrication Center 1321 Guerneville Road, Santa Rosa, California,
https://documents.geotracker.waterboards.ca.gov/esi/uploads/geo_report/4061959385/SL0609714920.PDF

Huffman, M.E., and Armstrong, C.F., 1980; Geology for Planning in Sonoma County: California Division of Mines and Geology, Special Report 120, Scale 1:62,500.

McLaughlin, R.J., et. al., 2008, Geologic and Geophysical Framework of the Santa Rosa 7.5' Quadrangle, Sonoma County, California: U.S. Geological Survey, Open-File Report 2008-1009, Scale 1:24,000.

1650 West Steele Lane
Job No. 3674.0
January 3, 2020
Page 3

On December 3, 2019, our engineering geologist observed the surface conditions and explored the subsurface conditions to the extent of two test borings. The test borings locations, as approximately shown on Plate 1, were located by our geologist by estimating distances from approximate property boundaries and features indicated on a partial City of Santa Rosa GIS image. The test borings locations should be considered accurate only to the degree implied by the method used. The test borings were drilled with a truck mounted drill rig equipped with 8-inch diameter hollow stem augers. The completed test holes were excavated to depths ranging to about 43 feet.

Our engineering geologist logged the conditions exposed and obtained relatively undisturbed samples at selected intervals for visual identification and laboratory testing. Relatively undisturbed samples were obtained with a 2.4-inch, inside-diameter, split-spoon sampler driven with a 140-pound hammer. The stroke during driving was about 30 inches. The blows required to drive the sampler were recorded and converted to equivalent standard penetration blow counts for correlation with other data. Representative samples of the soils encountered were laboratory tested to determine their classification and Atterberg limits. Logs of the borings showing the materials encountered, sample depths, and converted blow counts are presented on Plates 2 and 3. The materials are classified in accordance with the Unified Soil Classification System, presented on Plate 4.

The logs show our interpretation of the subsurface conditions on the date and locations indicated, and it is not warranted that they are representative of the subsurface conditions at other locations and times. Also, the stratification lines on the logs represent the approximate boundaries between material types; the transition may be gradual. The test borings were not backfilled with compacted fill.

SITE CONDITIONS

The site is located at the southeast corner of the intersection of West Steele Lane and Meadowbrook Court in Santa Rosa (approximate Google Earth site coordinates: 38.459785°; -122.734384°). The parcel is currently undeveloped and covered with a moderate growth of trees, grass and weeds. We understand that the property was previously developed with a residential structure in the northwest corner of the lot which has been removed.

The published geologic references indicate that the site is underlain by alluvium consisting of sand, gravel, silt, and clay. The results of our field exploration indicate that the site is typically covered by about 3 to 5 feet of variable density old fills consisting of medium stiff sandy clays, medium dense sandy gravels and loose sands. The sandy clays encountered in the old fills are moderately to highly expansive. Underlying the old fills is about 2 feet of soft sandy clays that are expansive, weak and porous. Porous/weak soils and variable density old fills are prone to

1650 West Steele Lane
Job No. 3674.0
January 3, 2020
Page 4

non-uniform settlement, and may collapse when loaded and saturated. The estimated depth of weak soils is shown on the right side of the test boring logs. Our visual classification and laboratory test results indicate that the natural surface soils are typically of moderate to high expansion potential. Moderate and highly expansive soils can heave and crack lightly loaded, shallow foundations and slabs-on-grade.

Underlying the surface soils are medium stiff to stiff sandy clays, and medium dense to dense clayey and sandy gravels. The underlying clay materials are of high expansion potential. Further, the underlay materials generally have moderate to high strength, and are relatively incompressible for the range of anticipated foundation loads.

Groundwater was encountered at about 7 feet deep in Test Borings 1 and 2. However, groundwater conditions are expected to vary seasonally and at different locations. We have previously observed shallow perched water in the project vicinity. Our work did not include an evaluation of flooding.

The published geologic maps do not indicate active faults at this site. The nearest fault zones considered seismically active (experiencing surface rupture within about the last 11,000 years) are the Healdsburg-Rodgers Creek and San Andreas faults, located about 4 miles to the northeast and 16 miles to the southwest, respectively.

DISCUSSION AND CONCLUSIONS

Based on the results of our investigation, we conclude that the planned development is feasible from a geotechnical engineering viewpoint. The primary geotechnical concern is the presence of relatively weak surface soils, variable density old fills and expansive soils.

Upon saturation, weak/porous surface soils and variable density old fills will lose strength and/or consolidate rapidly under loads of new fill and structural elements. Saturation will occur when the natural evaporation of soil moisture is inhibited by new fill and structural elements. Expansive soils undergo significant volumetric changes with seasonal variations in moisture content. Such movements can result in unacceptable heaving and cracking of lightly-loaded structural elements, such as foundations, pools, pavements and concrete slabs.

Weak surface soils will consolidate under slab-on-grade floors. Expansive materials can result in heaving and cracking of slabs. Typically, living area or similar 'critical-use' slabs should be: 1) structurally supported on the foundation system and provided with a void beneath the slab to allow for uplift; or 2) weak/porous surface soils must be upgraded in building areas by removal and recompaction for their full depth; and 3) a minimum 30-inch thick confining and moisture

1650 West Steele Lane
Job No. 3674.0
January 3, 2020
Page 5

protecting blanket of imported, non-expansive (“select”) fill must be placed. If post tensioned concrete slabs are planned, we should be contacted for additional recommendations.

Alternately, suitable foundation support can be achieved by deepening foundations to penetrate through the weak soils and the zone of seasonal moisture variation (about 3 feet) into more suitable underlying materials. Deepened foundations could consist of drilled piers or spread footings placed entirely on engineered select fill.

Less critical slabs (such for garage or exterior areas) may be constructed on properly prepared subgrade provided that: 1) the slabs are separated from foundations; 2) slabs are designed to minimize cracking (i.e. reinforced and provided with control joints); and 3) moderate to severe soil related cracking and movement is considered acceptable. Improved performance of slabs could be attained by removal and replacement of some, or all, of the weak and expansive soils with non-expansive engineered fill.

Within asphalt paved roadways and roadway fill areas, the weak soils and variable density, old fills, if present, must be excavated and recompact to at least 18 inches below existing grade or planned subgrade, whichever is deeper. Alternatively, the upper 18 inches of subgrade soils could be lime treated in place. This alternative could reduce excavation operations and potentially permit grading during wet conditions (i.e., Spring or early Summer).

Control of surface run-off will significantly enhance the stability of the site. The discharge of roof gutter downspouts must be collected into non-perforated pipes. All collected water must be discharged into the storm drain system or in erosion resistant areas, well away from the development. Outlets should be provided in slab rock at slab-on-grade floors to reduce the risk of water build up in the slab rock. Increased mitigation, if desired, could be provided by installation of trench subdrains beneath the slab rock.

Groundwater was encountered in our test borings at about 7 feet deep. However, groundwater conditions are expected to vary. We have previously encountered shallow perched groundwater within the natural soils in the project vicinity. Excavations performed in the summer or autumn months will typically result in a lower risk of encountering groundwater.

Our review of liquefaction susceptibility maps prepared by USGS and CGS for the Association of Bay Area Governments (ABAG) indicates that the site is located in an area of “moderate” liquefaction susceptibility. Liquefaction is a rapid loss of shear strength experienced in saturated, cohesionless sands and occasionally in soft silts below the groundwater level due to an increase in pore water pressure. The occurrence of this phenomenon is dependent on many factors, including the intensity and duration of ground shaking, soil density, particle size distribution, and position of the ground water table (Seed and Idriss, 1982). Loose, cohesionless

1650 West Steele Lane
Job No. 3674.0
January 3, 2020
Page 6

sands and soft silts below the water level and potentially susceptible to liquefaction were not observed during our subsurface exploration.

The published geologic maps do not indicate active faults on the site, therefore the risk of fault rupture during earthquakes is considered to be low. As common throughout Northern California, the site will be subject to severe shaking as result of earthquakes along active faults in the region. We anticipate that the intensity of earthquake shaking should be similar to that of other hillside sites in the vicinity. The intensity of future shaking will depend on the distance from the site to the earthquake focus, magnitude of the earthquake, and the response of the structure to the underlying soil and/or rock. Earthquake shaking could induce landsliding and other soil movements. Mitigation of earthquake shaking typically consists of designing and constructing improvements in strict accordance with current standards for earthquake resistant construction.

RECOMMENDATIONS

Site Preparation and Grading

Areas to be graded should be cleared of designated brush, rubble, debris and old fills. Material generated by the clearing operations should be removed from the site. Wells, cesspools, and other voids encountered or generated during clearing should be either backfilled with granular material or compacted soil, or capped with concrete as determined by us and in accordance with City of Santa Rosa requirements.

Areas to be graded should be stripped of the upper soils containing root growth and organic matter. We anticipate that the required depth of stripping will average about 3 to 6 inches. Deeper stripping will be required to remove localized heavy concentrations of root growth. The strippings should be removed from the site, stockpiled for reuse as topsoil, or mixed with at least two parts soil and used as fill in areas 10 feet beyond structures, walks and paved areas.

For the purpose of definition, "select fill areas" referred to in this report are buildings with shallow foundations and critical concrete slab areas and the zones extending for a distance of at least five feet beyond outside edges of slabs and perimeter footings or other footings extending from a building. In select fill areas, weak surface soils and variable density old fills should be excavated for their full depth (5-½ to 6-½ feet based on our test borings). Where expansive soils are encountered, additional excavation will be necessary to provide space for a minimum of 30 inches of select or lime treated fill. In paved roadways and roadway fill areas, weak soils and variable density, old fills (if encountered) should be excavated to at least 18 inches below existing grade or planned subgrade, whichever is deeper. Where possible, grading should extend beyond the road shoulder at least 1 foot. Where deepened foundations are used for support of the

1650 West Steele Lane
Job No. 3674.0
January 3, 2020
Page 7

structure and no critical use slab-on-grade floors are planned (or where structurally supported slabs are used), excavation of weak soils will not be necessary.

Within the select fill areas, the exposed bottoms should be scarified, uniformly moisture conditioned to 4 percent above optimum moisture content (2 percent for low expansive soils), and compacted to at least 90 percent relative compaction. Relative compaction refers to the in-place dry density of the soil expressed as a percentage of the maximum dry density of the same soil, as determined by ASTM D 1557-12. Optimum moisture content is the water content (percentage by dry weight) corresponding to the maximum dry density.

If grading is performed during the winter or spring seasons, we anticipate that higher groundwater conditions may be encountered. Severe groundwater conditions may result in the need for dewatering, placement of stabilization fabrics, and/or placement of ballast rock to achieve stable excavation bottoms.

The on-site soils should be suitable for reuse as general fill provided that: 1) all rock sizes greater than 6 inches in largest dimension and perishable materials are removed, and 2) the fill materials are approved by us prior to use. On-site expansive soils will not be suitable for use as select fill within 30 inches or within 12 inches, if lime treated, of subgrade where shallow foundations or critical slabs are used. Imported, non-expansive fill, should be free of organic matter, and should conform to the following requirements:

Sieve Size	Percent Passing
6-Inch	100
4-Inch	90 - 100
No. 200	15 - 60

Liquid Limit - 40 Maximum
Plasticity Index - 15 Maximum
(ASTM D 4318-10 Wet Test Method)

If lime treatment is used in lieu of select fill, the lime treated materials should be prepared with Quicklime, in accordance with Section 24 of Caltrans Standard Specifications, latest edition, in maximum lifts of 15 inches (depending on compaction equipment). A pH of 12.4, or higher, determined in accordance with ASTM test procedures, should be achieved when establishing the percentage of lime required. Typically, 5 to 6 percent lime will be required. A sample of the Quicklime proposed for use will need to be tested to confirm the specific percentage of lime needed.

1650 West Steele Lane
Job No. 3674.0
January 3, 2020
Page 8

Fill should be placed in thin lifts (normally 6 to 8 inches depending on compaction equipment), uniformly moisture conditioned to at least 2 percent above optimum moisture content (4 percent for expansive soils), and compacted to at least 90 percent relative compaction. The upper six inches of subgrade surfaces that are subject to vehicle loads should be compacted to at least 95 percent relative compaction (93 percent for expansive soils). All surfaces should be finished to present a smooth, unyielding subgrade.

Foundations

Foundations for the buildings may consist of spread footings that extend into firm materials (firm soils or engineered fill) or drilled, cast-in-place, reinforced concrete piers. We do not recommend mixing foundation types within individual structures.

Spread Foundations

Spread footings should be at least 12 inches wide, 12 inches deep, and extend at least 12 inches into firm materials or engineered fill. If expansive materials are exposed in foundation excavations, the expansive materials should be maintained at least 4 percent above optimum moisture content until concrete is placed. Further, foundations bearing in expansive materials must be deepened to at least 36 inches below lowest adjacent grade. Perimeter wall footings should be continuous.

Spread footings bearing into firm soils can be designed using an allowable bearing pressure of 2,000 and 3,000 pounds per square foot (psf) for dead plus long-term live loads and total design loads, respectively. We should observe the footing excavations prior to the placement of reinforcing steel and concrete.

The portion of the foundations extending into firm materials may impose a passive equivalent fluid pressure of 350 pounds per cubic foot (pcf) (triangular distribution) and a friction factor of 0.35 times the net vertical dead load. Passive pressures should be neglected within the upper foot, unless footings are confined by other construction.

Drilled Pier and Gradebeam Foundations

Foundation support can be obtained from drilled, cast-in-place, reinforced concrete piers. Piers should be at least 14 inches in diameter and extend at least 4 feet into firm soil below the weak soils. All piers should be at least 10 feet deep and should not be closer than 3 pier diameters, center to center.

1650 West Steele Lane
Job No. 3674.0
January 3, 2020
Page 9

The portion of the piers extending into firm soil, below the weak soils can impose 750 psf in skin friction. Perimeter piers should be interconnected with gradebeams designed to support the design structural loads per current code requirements. Pullout capacity of the piers should be considered as one-half the downward capacity. End bearing should be neglected because of the difficulty of cleaning out small diameter pier holes, and the uncertainty of mobilizing end bearing and skin friction simultaneously.

The pier holes should contain no more than 3 inches of slough, and the remaining slough should be tamped with a heavy timber, or similar, prior to concrete placement to prevent wet concrete from settling. Excess concrete must be removed to planned dimensions, from the bottom of gradebeams and tops of piers.

The portion of the piers extending into firm material may impose a passive equivalent fluid pressure of 350 pcf acting on two pier diameters. Passive pressure should be neglected within the upper 12 inches of pad grade unless foundations are confined by other construction.

The gradebeams should be designed and reinforced as directed by the structural engineer to resist uplift pressures of 1,000 psf as the expansive soils/sediment swell with increasing moisture content. It will be necessary to confirm that the expansive materials are fully swelled prior to drilling and during concrete placement of the drilled piers and gradebeams to reduce the risk of future expansion and heaving of the surface soils.

At the time of our exploration, groundwater was encountered in our test borings as shallow as about 7 feet. If groundwater is encountered, it will be necessary to place the concrete by the tremie method or dewater the holes. If caving soils are encountered during pier drilling, it may be necessary to case the holes.

We should observe the start of pier drilling operations to note the conditions exposed and provide recommendations to the contractor. We should observe the completed pier excavations prior to the placement of reinforcing steel and concrete.

Seismic Design Criteria

Using Google Earth site latitude and longitude coordinates of 38.459785°; -122.734384°, respectively, the following seismic design criteria is based on 2019 CBC guidelines, ASCE 7-16 and the USGS Earthquake Ground Motion Parameters:

Spectral Response Acceleration, S_s (0.2 sec.) – 2.159g
Spectral Response Acceleration, S_1 (1.0 sec.) – 0.834g
Seismic Design Category – E

1650 West Steele Lane
Job No. 3674.0
January 3, 2020
Page 10

Title 24, Part 2, Section 1613.2.2, of the 2019 CBC indicates that site categorization for seismic design should be based on the average soil values within the upper 100 feet of the site. Although the scope of our investigation was limited to relatively shallow test borings (ranging to about 43 feet deep), we estimate that a Site Classification “D” will be appropriate for design. Upon request, we could perform supplemental exploration to determine the site specific subsurface conditions ranging to 100 feet.

Concrete Slab-On-Grade

Provided surface materials are prepared as recommended in the "Site Preparation and Grading" section of this report, critical slabs-on-grade may be used. Non-critical exterior area slabs may be constructed on properly prepared subgrade provided that: 1) the slabs are separated from foundations; 2) slabs are designed to minimize cracking (i.e. reinforced and provided with control joints); and 3) some soil related cracking and differential movement is considered acceptable. We should be contacted if improved performance of the slabs is desired.

Slab thickness should be recommended by the structural engineer to support the anticipated loads and to reduce cracking. Some cracking of slabs must be anticipated considering concrete shrinkage. Reinforcing must be carefully installed in accordance with the structural engineer's recommendations to minimize the potential of cracking. We typically recommend the use of rebar reinforcement, placed on blocks. We have commonly observed that welded wire mesh is not properly located in the slabs. Control and expansion joints should be provided, as appropriate, to mitigate the effects of differential settlement.

Interior slab-on-grade floors should be underlain with a capillary moisture break and cushion layer consisting of at least 4 inches of clean, free-draining crushed rock (slab base rock). The crushed rock should be at least 1/4-inch, and no larger than 3/4-inch, in size.

Moisture will condense on the underside of slabs. Where moisture migration through slabs is detrimental, waterproofing methods and specifications designed by others should be incorporated into the project plans. Outlets should be provided in the slab rock to reduce the risk of water build up in the slab rock. Exterior slabs should be carefully separated from foundations with felt paper, mastic, or other positive and low friction separation.

Asphalt Pavement Structural Sections

Using an R-Value of 5 and the assumed Traffic Indices (T.I.'s) below, we recommend the following pavement sections. Traffic Indices are typically provided by the Project Civil Engineer. Construction traffic should be considered for the determination of the T.I.'s. We

1650 West Steele Lane
Job No. 3674.0
January 3, 2020
Page 11

would be pleased to evaluate and provide recommended T.I.'s for the project if anticipated traffic loadings are available.

T.I.	Asphalt Concrete (inches)	Class II * Aggregate Base (inches)
4.0 and 4.5	3	10
5.0	3	11

*R-Value = 78 minimum

The flexible pavement materials and construction methods should conform to the quality requirements of the State of California, Caltrans Standard Specifications, current edition, and that of Sonoma County.

Prior to preparation of the subgrade, all underground utilities in the paved areas should be installed and properly backfilled, and the concrete curbs and gutters or header-boards should be in place. Subgrade soil should be uniformly moisture conditioned to 2 percent above optimum moisture content (4 percent above for expansive soils) and compacted to at least 95 percent relative compaction (93 percent for expansive soils), providing a firm and unyielding surface. This may require scarifying and recompacting to achieve uniformity. The aggregate base materials should be placed in thin lifts in a manner to prevent segregation, uniformly moisture conditioned, and compacted to at least 95 percent relative compaction to provide a smooth, unyielding surface.

The City of Santa Rosa requires recommendations for pavement edge treatment to protect against expansive soil movements (shrink or swell). Edge cracking can be reduced by installation of a perimeter moisture vapor cutoff barrier. The cutoff barrier could consist of a compacted select fill dike 36 inches deep and 8 feet wide, or a concrete curb 4 inches wide and at least 30 inches deep. Conventional curb and sidewalk also provides some protection. Where the soils at the pavement edges are subject to wetting and drying, edge cracking should be anticipated. Periodic patching should be performed to prevent water from entering the cracks.

Geotechnical Engineering Drainage

Ponding water will be detrimental to foundations, therefore the site should be graded to provide positive drainage away from improvements. Roofs should be provided with gutters, and the downspouts connected to the site storm drain system discharging in erosion resistant areas well

1650 West Steele Lane
Job No. 3674.0
January 3, 2020
Page 12

away from the structures and slopes. Roof downspouts and surface drains must be maintained entirely separate from subsurface drainage. As requested, we can assist in providing suitable drainage discharge locations.

Where crawl spaces are used, the crawl space areas should be sloped to drain and provided with outlets through foundations. In critical use slab areas, outlets should be provided in the slab rock at slab-on-grade floors to reduce the risk of water build up in the slab rock. Increased mitigation, if desired, could be provided by installation of trench subdrains beneath the slab rock. The subdrains, if constructed, should consist of 12-inch deep by 12-inch wide trenches that cross the slab areas, as directed by us. The slab rock should be connected to the subdrain rock. The subdrain pipe should consist of PVC Schedule 40 or ABS with an SDR of 35 or better. The trench should be backfilled with clean, free-draining, 3/4 or 1-1/2-inch crushed drain rock, separated from adjacent soil/rock by a non-woven filter fabric. As an alternative, Class II permeable material complying with Caltrans Section 68, may be used without filter fabric. Underground utility trenches could potentially also be used as subdrains if properly designed. We should be consulted to incorporate the utility trenches into the drainage system on a case by case basis.

Supplemental Services

We should be contacted during design to discuss our recommendations and the design approach. We should review the final plans for conformance with the intent of our recommendations.

During grading and foundation construction, we should provide intermittent geotechnical engineering observations, along with necessary field and laboratory testing, during: 1) removal of weak soils; 2) fill placement and compaction; 3) preparation and compaction of subgrade; and 4) excavation of foundations. These observations and tests would allow us to check that the contractor's work conforms with the intent of our recommendations and the project plans and specifications. These observations also permit us to check that conditions encountered are as anticipated, and modify our recommendations, as necessary. Upon completion of the project, we should perform a final observation prior to occupancy. We should summarize the results of this work in a final report.

These supplemental services are performed on an as-requested basis, and we can accept absolutely no responsibility for items that we are not notified to observe. These supplemental services are in addition to this investigation and are charged for on an hourly basis in accordance with our Schedule of Charges. We must be provided with at least 48 hours notice for scheduling our initial site visit, and 24 hours thereafter.

BAUER ASSOCIATES, INC.

1650 West Steele Lane
Job No. 3674.0
January 3, 2020
Page 13

LIMITATIONS

We performed the investigation and prepared this report in accordance with generally accepted standards of the geotechnical engineering profession. No other warranty, either express or implied, is given.

If the project is revised, or if conditions different from those described in this report are encountered during construction, we should be notified immediately so that we can take timely action to modify our recommendations, if warranted. Site conditions and standards of practice change. Therefore, we should be notified to update this report if construction is not performed within 18 months of the submittal date.

We trust this provides the information you require at this time. If you have questions or wish to discuss this further, please call.

Very truly yours,

BAUER ASSOCIATES, INC

Steven J. Klick
Engineering Geologist



Bryce Bauer
Geotechnical Engineer



SJK/BB (gi/west steele lane)
Attachments: Plates 1 through 4
Email only



Reference: City of Santa Rosa GIS, 2019.
 Note: The locations of all features are approximate and may vary.



Reference North

BAUER ASSOCIATES, INC. GEOTECHNICAL CONSULTANTS	Job No: 3674.0 Date: 12/19 By: SJK	TEST HOLE LOCATION PLAN 1650 WEST STEELE LANE Santa Rosa, California	PLATE 1

Laboratory Tests

Blows/Foot*
Moisture Content (%)
Dry Density (pcf)
Depth

Sample

Equipment: 8" Hollow Stem Auger
Date: December 3, 2019
Elevation: Not Available

Atterberg Limits
LL = 52
PL = 18
PI = 34
Minus No. 200
= 60 percent

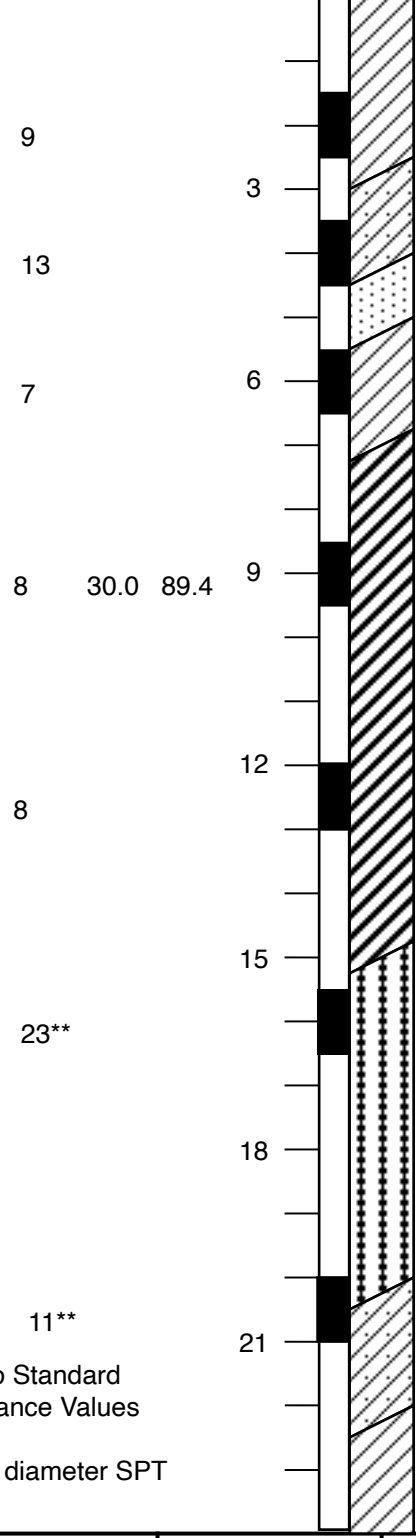

DARK BROWN CLAY (CL)
medium stiff, moist, porous, trace gravel, fill

ORANGE BROWN GRAVELLY CLAYEY SAND (SC)
medium dense, moist, fill

ORANGE BROWN SAND (SP)
loose, moist, fill?

BROWN SANDY CLAY (CL)
medium stiff, moist, porous?



GRAY SANDY CLAY (CH)
medium stiff, moist

GRAY SANDY GRAVEL (GM)
medium dense to dense, saturated

very dense

BROWN CLAYEY GRAVELLY SAND (SC)
medium dense, saturated

GRAY SANDY CLAY (CL)
stiff, moist

Weak Soils

* Blows converted to Standard Penetration Resistance Values

** Sampled with 1.5" diameter SPT sampler

BAUER ASSOCIATES, INC. GEOTECHNICAL CONSULTANTS	Job No: 3674.0 Date: 12/19 By: SJK	LOG OF TEST BORING 1 1650 WEST STEELE LANE Santa Rosa, California	PLATE 2

Laboratory Tests

Blows/Foot*
Moisture Content (%)
Dry Density (pcf)

Depth

Sample

Equipment: 8" Hollow Stem Auger

Date: December 3, 2019

Elevation: Not Available

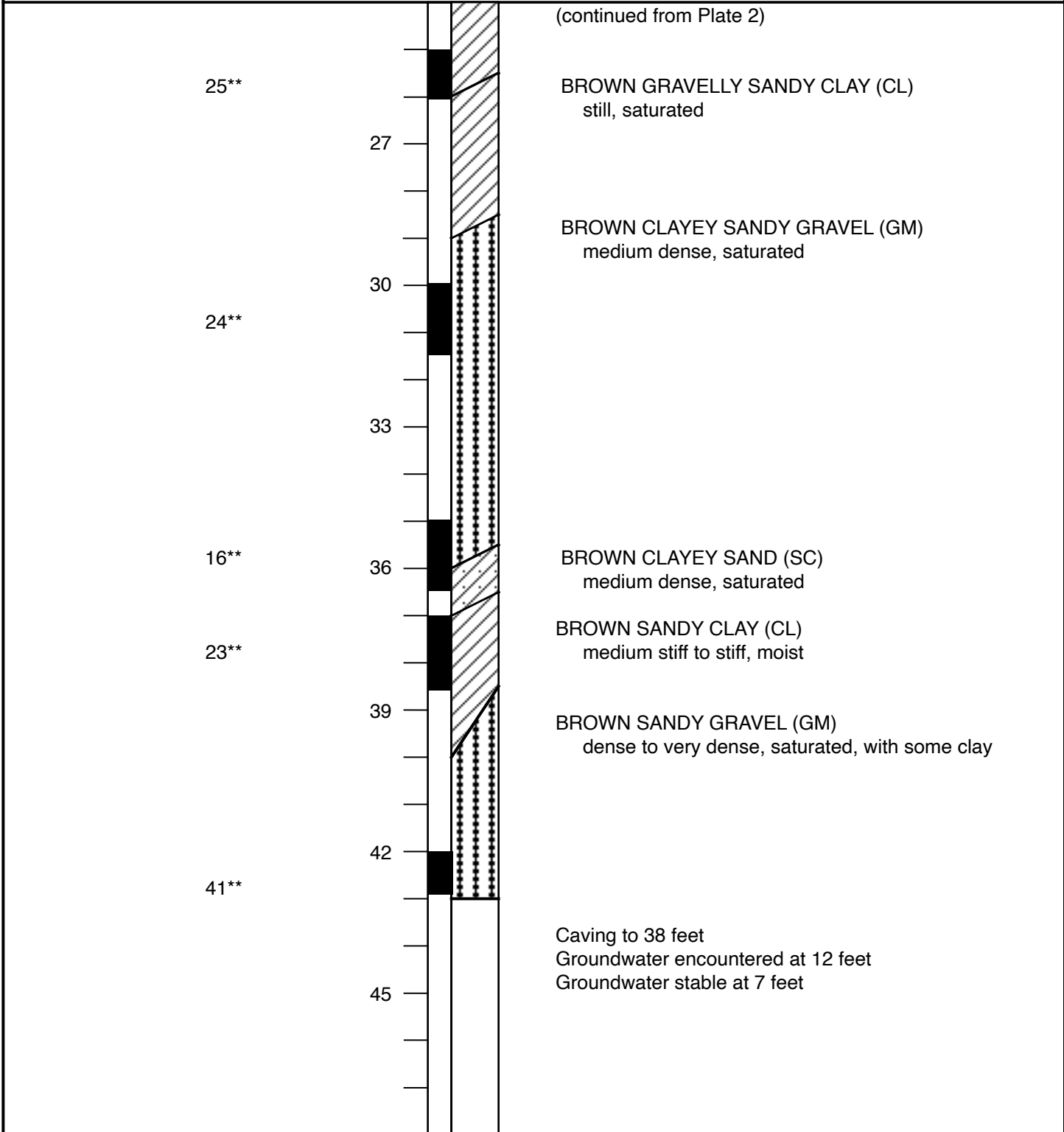

BAUER ASSOCIATES, INC.

GEOTECHNICAL CONSULTANTS

Job No: 3674.0

Date: 12/19

By: SK

LOG OF TEST BORING 1

1650 WEST STEELE LANE
Santa Rosa, California

PLATE

2a

Laboratory Tests

Blows/Foot*
Moisture Content (%)
Dry Density (pcf)

Depth

Sample

Equipment: 8" Hollow Stem Auger
Date: December 3, 2019
Elevation: Not Available

Atterberg Limits
LL = 68
PL = 19
PI = 49
Minus No. 200
= 97 percent

10

3

3

91.1 27.3

6

10

9

13

18**

12

15

18

21

DARK BROWN SANDY CLAY (CL)
medium stiff, moist, porous, some gravel

BROWN SANDY GRAVEL (GM)
medium dense, moist, fill

BROWN SANDY CLAY (CL)
soft, moist, porous

▽ GRAY CLAY (CH)
medium stiff to stiff, moist

GRAY CLAYEY SANDY GRAVEL (GM)
medium dense, saturated

No caving
Groundwater encountered at 12 feet
Groundwater stable at 7 feet

Weak Soils

BAUER ASSOCIATES, INC.

GEOTECHNICAL CONSULTANTS

Job No: 3674.0

Date: 12/19

By: SJK

LOG OF TEST BORING 2

1650 WEST STEELE LANE
Santa Rosa, California

PLATE

3

MAJOR DIVISIONS		TYPICAL NAMES		
COURSE GRAINED SOILS	GRAVELS more than half course fraction is larger than no. 4 sieve size	CLEAN GRAVELS WITH LITTLE OR NO FINES	GW	WELL GRADED GRAVELS, GRAVEL-SAND MIXTURES
			GP	POORLY GRADED GRAVELS, GRAVEL-SAND MIXTURES
		GRAVELS WITH OVER 12% FINES	GM	SILTY GRAVELS, POORLY GRADED GRAVEL-SAND MIXTURES
			GC	CLAYEY GRAVELS, POORLY GRADED GRAVEL-SAND MIXTURES
	SANDS more than half course fraction is smaller than no. 4 sieve size	CLEAN SANDS WITH LITTLE OR NO FINES	SW	WELL GRADED SANDS, GRAVELLY SANDS
			SP	POORLY GRADED SANDS, GRAVEL-SAND MIXTURES
		SANDS WITH OVER 12% FINES	SM	SILTY SANDS, POORLY GRADED SAND-SILT MIXTURES
			SC	CLAYEY SANDS, POORLY GRADED SAND-CLAY MIXTURES
FINE GRAINED SOILS	SILTS AND CLAYS LIQUID LIMIT LESS THAN 50	ML	INORGANIC SILTS, SILTY OR CLAYEY FINE SANDS, VERY FINE SANDS, ROCK FLOUR, CLAYEY SILTS WITH SLIGHT PLASTICITY	
		CL	INORGANIC SCLAYS OF LOW TO MEDIUM PLASTICITY, GRAVELLY CLAYS, SANDY CLAYS, SILTY CLAYS OR LEAN CLAYS	
		OL	ORGANIC CLAYS AND ORGANIC SILTY CLAYS OF LOW PLASTICITY	
	SILTS AND CLAYS LIQUID LIMIT GREATER THAN 50	MH	INORGANIC SILTS, MICACEOUS OR DIATOMACEOUS FINE SANDY OR SILTY SOILS, ELASTIC SILTS	
		CH	INORGANIC CLAYS OF HIGH PLASTICITY, FAT CLAYS	
		OH	ORGANIC CLAYS OF MEDIUM TO HIGH PLASTICITY, ORGANIC SILTS	
HIGHLY ORGANIC SOILS	Pt	PEAT AND OTHER HIGHLY ORGANIC SOILS		

KEY TO TEST DATA

LL - Liquid Limit (in %)
 PL - Plastic Limit (in %)
 SA - Sieve Analysis

		Shear Strength, psf		
		↓	↓	Confining Pressure, psf
Tx	320	(2600)		Unconsolidated Undrained Triaxial
Tx CU	320	(2600)		Consolidated Undrained Triaxial
DS	2750	(2600)		Consolidated Drained Direct Shear
UC	2000			Unconfined Compression

Notes: (1) All strength tests on 2.8" or 2.4" diameter sample unless otherwise indicated
 (2) * Indicates 1.4" diameter sample

DRILLING METHOD SYMBOLS



Auger Drilling



Diamond Core



Rotary Drilling

SAMPLER GRAPHIC SYMBOLS



Standard Penetration Test (SPT)



HQ Rock Core



Standard California Sampler (ID 2.5 in.)



No Sample Recovery

BAUER ASSOCIATES, INC.

GEOTECHNICAL CONSULTANTS

Job No: 3674.0

Date: 12/19

By: SJK

SOIL CLASSIFICATION CHART & KEY TO TEST DATA

1650 WEST STEELE LANE
 Santa Rosa, California

PLATE

4

Noise Impact Analysis Report 1650 West Steele Lane Multi-family Residential Project City of Santa Rosa, Sonoma County, California

Prepared for:

Hedgpeth Architects

2321 Bethards Drive Suite B

Santa Rosa, CA 95405

707.523.7010

Contact: Patrick O'Neil

Prepared by:

FirstCarbon Solutions

1350 Treat Boulevard, Suite 380

Walnut Creek, CA 94597

925.357.2562

Contact: Mary Bean, Project Director
Philip Ault, Project Manager, Noise and Air Quality Scientist

Date: July 2, 2020

THIS PAGE INTENTIONALLY LEFT BLANK

Table of Contents

Acronyms and Abbreviations	v
Section 1: Introduction	1
1.1 - Purpose of Analysis and Study Objectives.....	1
1.2 - Project Summary.....	1
Section 2: Noise and Vibration Fundamentals	9
2.1 - Characteristics of Noise	9
2.2 - Characteristics of Groundborne Vibration	11
Section 3: Regulatory Setting	15
3.1 - Federal Regulations	15
3.2 - State Regulations.....	16
3.3 - Local Regulations.....	16
Section 4: Thresholds of Significance and Impact Analysis	21
4.1 - Thresholds of Significance	21
4.2 - Noise Levels That Would Conflict with Any Land Use Plan, Policy, or Regulation.....	21
4.3 - Substantial Noise Increase in Excess of Standards	25
4.4 - Groundborne Vibration/Noise Levels.....	29
4.5 - Excessive Noise Levels from Airport Activity.....	31

Appendix A: Noise Modeling Data

List of Tables

Table 1: Typical Construction Equipment Maximum Noise Levels, L_{max}	10
Table 2: Vibration Levels of Construction Equipment	12
Table 3: Summary of EPA Recommended Noise Levels to Protect Public Welfare.....	15
Table 4: Federal Transit Administration Construction Vibration Impact Criteria.....	16
Table 5: Land Use Compatibility for Community Noise Exposure (dBA CNEL or L_{dn})	18

List of Exhibits

Exhibit 1: Regional Location Map	3
Exhibit 2: Local Vicinity Map, Aerial Base.....	5
Exhibit 3: Site Plan	7
Exhibit 4: Traffic Noise Contour Map.....	23

THIS PAGE INTENTIONALLY LEFT BLANK

ACRONYMS AND ABBREVIATIONS

ADT	Average Daily Traffic
APN	Assessor's Parcel Number
Caltrans	California Department of Transportation
CEQA	California Environmental Quality Act
CNEL	Community Noise Equivalent Level
dB	decibel
dBA	A-weighted decibel
du/acre	dwelling units per acre
EPA	United States Environmental Protection Agency
FCS	FirstCarbon Solutions
FHWA	Federal Highway Administration
FTA	Federal Transit Administration
in/sec	inch per second
L _{dn}	day/night average sound level
L _{eq}	equivalent sound level
L _{max}	maximum noise/sound level
MM	Mitigation Measure
PPV	peak particle velocity
rms	root mean square
TTM	Tentative Tract Map
VdB	velocity in decibels

THIS PAGE INTENTIONALLY LEFT BLANK

SECTION 1: INTRODUCTION

1.1 - Purpose of Analysis and Study Objectives

This Noise Impact Analysis has been prepared by FirstCarbon Solutions (FCS) to determine the off-site and on-site noise impacts associated with the proposed 1650 West Steele Lane Multi-family Residential Project (proposed project). The following is provided in this report:

- A description of the study area, project site, and proposed project.
- Information regarding the fundamentals of noise and vibration.
- A description of the local noise guidelines and standards.
- An analysis of the potential short-term, construction-related noise and vibration impacts from the proposed project.
- An analysis of long-term, operations-related noise and vibration impacts from the proposed project.

1.2 - Project Summary

The project site is located at 1650 West Steele Lane, just west of the Highway 101 interchange in the City of Santa Rosa. The regional location is shown in Exhibit 1. The project site is vacant and contains scattered mature trees and vegetation.

The project site is bounded on the north and east by commercial and retail uses; apartments and single-family residences are located to the south and west. The local vicinity map is shown in Exhibit 2.

The proposed project would develop a 36-unit apartment building that qualifies for an in-fill exemption under the California Environmental Quality Act (CEQA). The apartment building would consist of a 3-story portion located within public right-of-way, with 2-story portions located at the rear and the interior side-yards to allow maximum southern solar exposure in the interior courtyard. Semi-private open space would be provided in walled patio gardens at the ground floor units, and balconies at upper level units. Communal open space would be provided at the courtyard on the ground floor, at the entry garden in front of the lobby, at the intersection of West Steele and Meadowbrook Court, and at the roof garden on the second floor. The proposed project would provide a total of 36 parking stalls, including covered parking for 25 cars in a 2-level automated parking structure at the east side yard, and surface parking at the south yard. A parking ratio of one stall per unit is proposed for this transit-oriented development. On-site short-term and long-term bicycle parking would also be provided. The site plan is shown in Exhibit 3.

THIS PAGE INTENTIONALLY LEFT BLANK

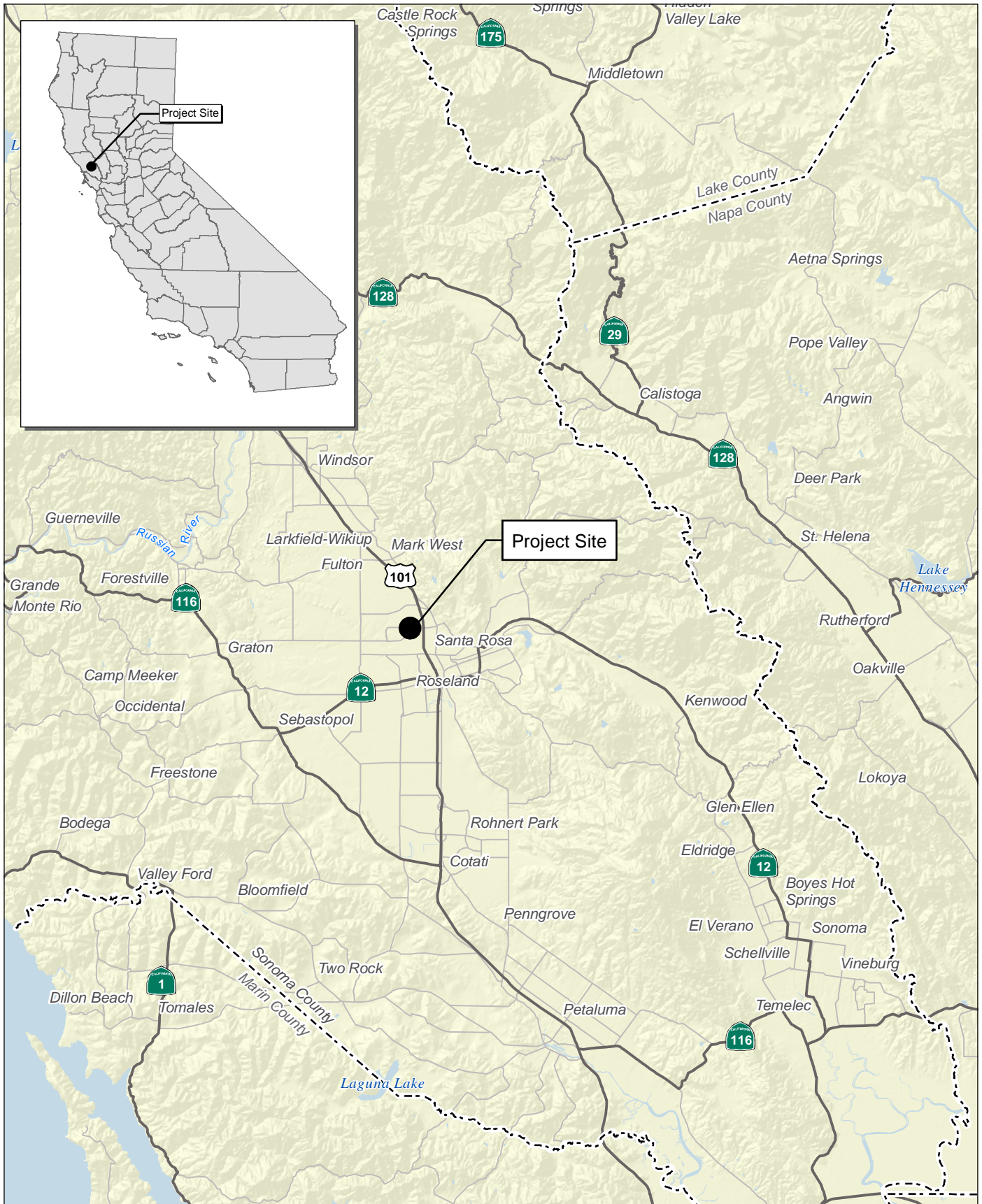

Source: Census 2000 Data, The CaSIL

FIRSTCARBON
SOLUTIONS™

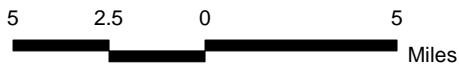
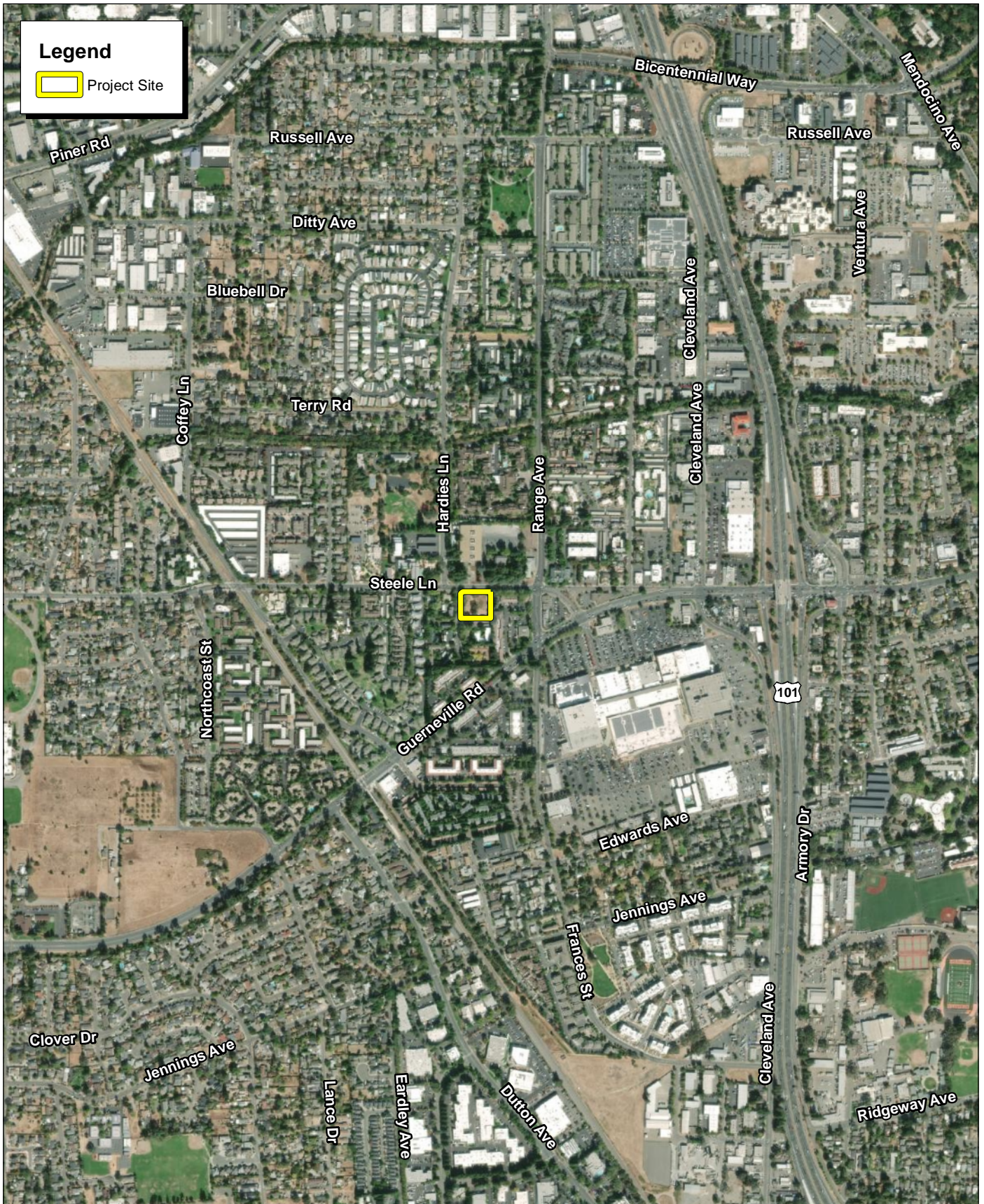

Exhibit 1 Regional Location Map

THIS PAGE INTENTIONALLY LEFT BLANK



Source: ESRI Aerial Imagery.



THIS PAGE INTENTIONALLY LEFT BLANK

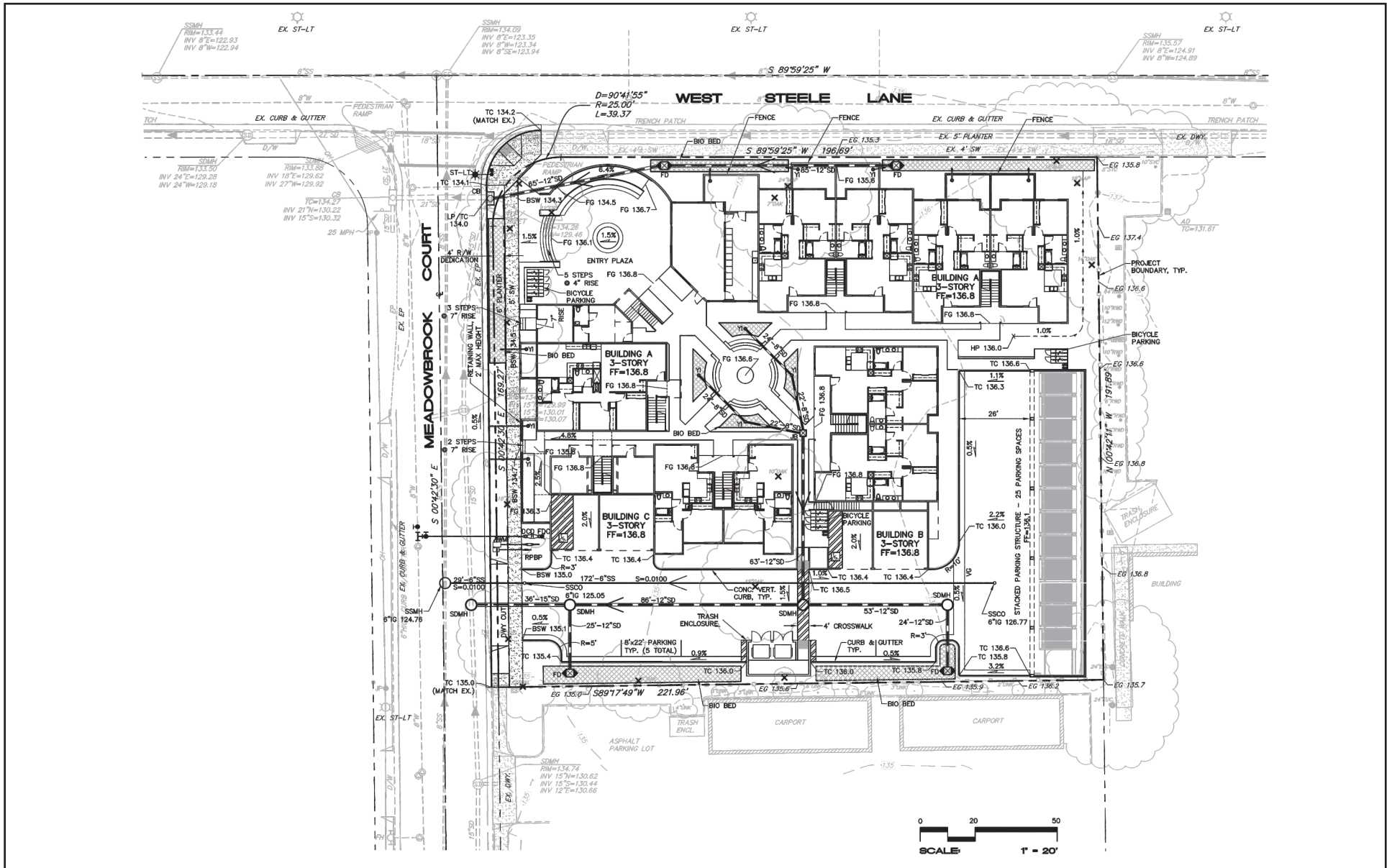

Source: Hedgpeth Architects, February 2020.



52350001 • 06/2020 | 3_site_plan.cdr

Exhibit 3 Site Plan

HEDGPETH ARCHITECTS
1650 WEST STEELE LANE MULTI-FAMILY RESIDENTIAL PROJECT
NOISE IMPACT ANALYSIS REPORT

THIS PAGE INTENTIONALLY LEFT BLANK

SECTION 2: NOISE AND VIBRATION FUNDAMENTALS

2.1 - Characteristics of Noise

Noise is generally defined as unwanted sound. Noise consists of any sound that may produce physiological or psychological damage and/or interfere with communication, work, rest, recreation, and sleep.

Several noise measurement scales exist which are used to describe noise in a particular location. A *decibel* (dB) is a unit of measurement that indicates the relative intensity of a sound. The 0 point on the dB scale is based on the lowest sound level that the healthy, unimpaired human ear can detect. Changes of 3.0 dB or less are only perceptible in laboratory environments. Audible increases in noise levels generally refer to a change of 3.0 dB or more, as this level has been found to be barely perceptible to the human ear in outdoor environments. Sound levels in dB are calculated on a logarithmic basis. An increase of 10 dB represents a 10-fold increase in acoustic energy, while 20 dB is 100 times more intense, 30 dB is 1,000 times more intense. Each 10-dB increase in sound level is perceived as approximately a doubling of loudness. Sound intensity is normally measured through the A-weighted sound level (dBA). This scale gives greater weight to the frequencies of sound to which the human ear is most sensitive.

Noise impacts can be described in three categories. The first is audible impacts, which refers to increases in noise levels noticeable to humans. An audible increase in noise levels generally refers to a change of 3.0 dB or greater, since this level has been found to be barely perceptible in exterior environments. The second category, potentially audible, refers to a change in the noise level between 1.0 and 3.0 dB. This range of noise levels has been found to be noticeable only in laboratory environments. The last category is changes in noise level of less than 1.0 dB, which are inaudible to the human ear. Only audible changes in existing ambient or background noise levels are considered potentially significant.

As noise spreads from a source, it loses energy so that the farther away the noise receiver is from the noise source, the lower the perceived noise level would be. Geometric spreading causes the sound level to attenuate or be reduced, resulting in a 6-dB reduction in the noise level for each doubling of distance from a single point source of noise to the noise-sensitive receptor of concern. A long, closely spaced continuous line of vehicles along a roadway becomes a line source and produces a 3 dBA decrease in sound level for each doubling of distance. However, experimental evidence has shown that where sound from a highway propagates close to “soft” ground (e.g., plowed farmland, grass, crops, etc.), the most suitable drop off rate to use is not 3 dBA but rather 4.5 dBA per distance doubling. There are many ways to rate noise for various time periods, but an appropriate rating of ambient noise affecting humans also accounts for the annoying effects of sound. The predominant rating scales for human communities in the State of California are the equivalent continuous sound level (L_{eq}) and community noise equivalent level (CNEL) or the day/night average level (L_{dn}) based on dBA. L_{eq} is the total sound energy of time-varying noise over a sample period. CNEL is the time-varying noise over a 24-hour period, with a 5-dBA weighting factor applied to the hourly L_{eq} for noises occurring from

7:00 p.m. to 10:00 p.m. (defined as relaxation hours) and a 10-dBA weighting factor applied to noise occurring from 10:00 p.m. to 7:00 a.m. (defined as sleeping hours). L_{dn} is similar to the CNEL scale but without the adjustment for events occurring during the evening hours. CNEL and L_{dn} are within one dBA of each other and are normally exchangeable. The noise adjustments are added to the noise events occurring during the more sensitive hours.

Other noise rating scales of importance when assessing the annoyance factor include the maximum noise level (L_{max}), which is the highest exponential time-averaged sound level that occurs during a stated time period. The noise environments discussed in this analysis are specified in terms of maximum levels denoted by L_{max} for short-term noise impacts. L_{max} reflects peak operating conditions and addresses the annoying aspects of intermittent noise.

Common sources of noise in urban environments include mobile sources, such as traffic, and stationary sources, such as mechanical equipment or construction operations.

Construction is performed in discrete steps, each of which has its own mix of equipment and, consequently, its own noise characteristics. These various sequential phases would change the character of the noise generated on each construction site and, therefore, would change the noise levels as construction progresses. Despite the variety in the type and size of construction equipment, similarities in the dominant noise sources and patterns of operation allow construction-related noise ranges to be categorized by work phase. Table 1 shows typical noise levels of construction equipment as measured at a distance of 50 feet from the operating equipment. Construction-period noise levels are higher than background ambient noise levels, but they eventually cease once construction is complete.

Table 1: Typical Construction Equipment Maximum Noise Levels, L_{max}

Category	Impact Device? (Yes/No)	Specification Maximum Sound Levels for Analysis (dBA at 50 feet)
Pickup Truck	No	55
Pumps	No	77
Air Compressors	No	80
Backhoe	No	80
Front-End Loaders	No	80
Portable Generators	No	82
Dump Truck	No	84
Tractors	No	84
Auger Drill Rig	No	85
Concrete Mixer Truck	No	85
Cranes	No	85

Type of Equipment	Impact Device? (Yes/No)	Specification Maximum Sound Levels for Analysis (dBA at 50 feet)
Dozers	No	85
Excavators	No	85
Graders	No	85
Jackhammers	Yes	85
Man Lift	No	85
Paver	No	85
Pneumatic Tools	No	85
Rollers	No	85
Scrapers	No	85
Concrete/Industrial Saws	No	90
Impact Pile Driver	Yes	95
Vibratory Pile Driver	No	95

Source: Federal Highway Administration (FHWA) 2006.

2.2 - Characteristics of Groundborne Vibration

Groundborne vibrations consist of rapidly fluctuating motions within the ground that have an average motion of zero. Vibrating objects in contact with the ground radiate vibration waves through various soil and rock strata to the foundations of nearby buildings.

Although groundborne vibration can be felt outdoors, it is typically only an annoyance to people indoors where the associated effects of the shaking of a building can be notable. When assessing annoyance from groundborne vibration, vibration is typically expressed as root mean square (rms) velocity in units of decibels of 1 micro-inch per second. To distinguish these vibration levels referenced in decibels from noise levels referenced in decibels, the unit is written as “VdB.”

In extreme cases, excessive groundborne vibration has the potential to cause structural damage to buildings. Common sources of groundborne vibration include construction activities such as blasting, pile driving, and operating heavy earthmoving equipment. However, construction vibration impacts on building structures are generally assessed in terms of peak particle velocity (PPV). For purposes of this analysis, project-related impacts are expressed in terms of PPV. Typical vibration source levels from construction equipment are shown in Table 2.

Table 2: Vibration Levels of Construction Equipment

Construction Equipment	PPV at 25 Feet (inches/second)	rms Velocity in Decibels (VdB) at 25 Feet
Water Trucks	0.001	57
Scraper	0.002	58
Bulldozer (Small)	0.003	58
Jackhammer	0.035	79
Concrete Mixer	0.046	81
Concrete Pump	0.046	81
Paver	0.046	81
Pickup Truck	0.046	81
Auger Drill Rig	0.051	82
Backhoe	0.051	82
Crane (Mobile)	0.051	82
Excavator	0.051	82
Grader	0.051	82
Loader	0.051	82
Loaded Trucks	0.076	86
Bulldozer (Large)	0.089	87
Caisson drilling	0.089	87
Vibratory Roller (Small)	0.101	88
Compactor	0.138	90
Clam shovel drop	0.202	94
Vibratory Roller (Large)	0.210	94
Pile Driver (Impact: typical)	0.644	104
Pile Driver (Impact: upper range)	1.518	112

Source: Compilation of scientific and academic literature, generated by Federal Transit Administration (FTA) and Federal Highway Administration (FHWA).

The propagation of groundborne vibration is not as simple to model as airborne noise. This is because noise in the air travels through a relatively uniform medium, while groundborne vibrations travel through the Earth, which may contain significant geological differences. Factors that influence groundborne vibration include:

- **Vibration source:** Type of activity or equipment, such as impact or mobile, and depth of vibration source;

- **Vibration path:** Soil type, rock layers, soil layering, depth to water table, and frost depth; and
- **Vibration receiver:** Foundation type, building construction, and acoustical absorption.

Among these factors that influence groundborne vibration, there are significant differences in the vibration characteristics when the source is underground compared to at the ground surface. In addition, soil conditions are known to have a strong influence on the levels of groundborne vibration. Among the most important factors are the stiffness and internal damping of the soil and the depth to bedrock. Vibration propagation is more efficient in stiff clay soils than in loose sandy soils, and shallow rock seems to concentrate the vibration energy close to the surface, and can result in groundborne vibration problems at large distance from the source. Factors such as layering of the soil and depth to the water table can have significant effects on the propagation of groundborne vibration. Soft, loose, sandy soils tend to attenuate more vibration energy than hard, rocky materials. Vibration propagation through groundwater is more efficient than through sandy soils. There are three main types of vibration propagation: surface, compression, and shear waves. Surface waves, or Rayleigh waves, travel along the ground's surface. These waves carry most of their energy along an expanding circular wave front, similar to ripples produced by throwing a rock into a pool of water. P-waves, or compression waves, are body waves that carry their energy along an expanding spherical wave front. The particle motion in these waves is longitudinal (i.e., in a "push-pull" fashion). P-waves are analogous to airborne sound waves. S-waves, or shear waves, are also body waves that carry energy along an expanding spherical wave front. However, unlike P-waves, the particle motion is transverse, or side-to-side and perpendicular to the direction of propagation.

As vibration waves propagate from a source, the vibration energy decreases in a logarithmic nature and the vibration levels typically decrease by 6 VdB per doubling of the distance from the vibration source. As stated above, this drop-off rate can vary greatly depending on the soil type, but it has been shown to be effective enough for screening purposes, in order to identify potential vibration impacts that may need to be studied through actual field tests. The vibration level (calculated below as PPV) at a distance from a point source can generally be calculated using the vibration reference equation:

$$PPV = PPV_{ref} * (25/D)^n \text{ (in/sec)}$$

Where:

PPV_{ref} = reference measurement at 25 feet from vibration source
D = distance from equipment to property line
n = vibration attenuation rate through ground

According to Section 7 of the Federal Transit Administration (FTA) Transit Noise and Vibration Impact Assessment Manual, an "n" value of 1.5 is recommended to calculate vibration propagation through typical soil conditions.¹

¹ Federal Transit Administration (FTA). 2018. Transit Noise and Vibration Impact Assessment Manual. September.

THIS PAGE INTENTIONALLY LEFT BLANK

SECTION 3: REGULATORY SETTING

3.1 - Federal Regulations

3.1.1 - United States Environmental Protection Agency

In 1972, Congress enacted the Noise Control Act. This Act authorized the United States Environmental Protection Agency (EPA) to publish descriptive data on the effects of noise and establish levels of sound “requisite to protect the public welfare with an adequate margin of safety.” These levels are separated into health (hearing loss levels) and welfare (annoyance levels) categories, as shown in Table 3. The EPA cautions that these identified levels are not standards because they do not take into account the cost or feasibility of the levels.

For protection against hearing loss, 96 percent of the population would be protected if sound levels are less than or equal to an $L_{eq(24)}$ of 70 dBA. The “(24)” signifies an L_{eq} duration of 24 hours. The EPA activity and interference guidelines are designed to ensure reliable speech communication at about 5 feet in the outdoor environment. For outdoor and indoor environments, interference with activity and annoyance should not occur if levels are below 55 dBA and 45 dBA, respectively.

Table 3: Summary of EPA Recommended Noise Levels to Protect Public Welfare

Effect	Level	Area
Hearing loss	$L_{eq(24)} \leq 70$ dB	All areas
Outdoor activity interference and annoyance	$L_{dn} \leq 55$ dB	Outdoors in residential areas and farms and other outdoor areas where people spend widely varying amounts of time and other places in which quiet is a basis for use.
	$L_{eq(24)} \leq 55$ dB	Outdoor areas where people spend limited amounts of time, such as school yards, playgrounds, etc.
Indoor activity interference and annoyance	$L_{eq} \leq 45$ dB	Indoor residential areas.
	$L_{eq(24)} \leq 45$ dB	Other indoor areas with human activities such as schools, etc.

Source: EPA 1974.

3.1.2 - Federal Transit Administration

The FTA has established industry accepted standards for vibration impact criteria and impact assessment. These guidelines are published in its Transit Noise and Vibration Impact Assessment Manual.² The FTA Guidelines include thresholds for construction vibration impacts for various structural categories as shown in Table 4.

² Federal Transit Administration (FTA). 2018. Transit Noise and Vibration Impact Assessment Manual. September.

Table 4: Federal Transit Administration Construction Vibration Impact Criteria

Building Category	PPV (in/sec)	Approximate VdB
I. Reinforced—Concrete, Steel or Timber (no plaster)	0.5	102
II. Engineered Concrete and Masonry (no plaster)	0.3	98
III. Non Engineered Timber and Masonry Buildings	0.2	94
IV. Buildings Extremely Susceptible to Vibration Damage	0.12	90
Note: VdB = velocity in decibels in/sec = inch per second Source: FTA. 2018. Transit Noise and Vibration Impact Assessment Manual. September		

3.2 - State Regulations

The State of California has established regulations that help prevent adverse impacts to occupants of buildings located near noise sources. Referred to as the “State Noise Insulation Standard,” it requires buildings to meet performance standards through design and/or building materials that would offset any noise source in the vicinity of the receptor. State regulations include requirements for the construction of new hotels, motels, apartment houses, and dwellings other than detached single-family dwellings that are intended to limit the extent of noise transmitted into habitable spaces. These requirements are found in the California Code of Regulations, Title 24 (known as the Building Standards Administrative Code), Part 2 (known as the California Building Code), Appendix Chapters 12 and 12A. For limiting noise transmitted between adjacent dwelling units, the noise insulation standards specify the extent to which walls, doors, and floor-ceiling assemblies must block or absorb sound. For limiting noise from exterior noise sources, the noise insulation standards set an interior standard of 45 dBA CNEL in any habitable room with all doors and windows closed. In addition, the standards require preparation of an acoustical analysis demonstrating the manner in which dwelling units have been designed to meet this interior standard, where such units are proposed in an area with exterior noise levels greater than 60 dBA CNEL.

The State has also established land use compatibility guidelines for determining acceptable noise levels for specified land uses. The City of Santa Rosa has adopted and modified those guidelines as described as follows.

3.3 - Local Regulations

The project site is located within the City of Santa Rosa and this analysis was performed using the City’s noise regulations. The City of Santa Rosa addresses noise in the Noise Element of the Santa Rosa General Plan 2035 (2009)³ and in the City of Santa Rosa Municipal Code.⁴

³ City of Santa Rosa. 2009. Santa Rosa General Plan 2035. November.

⁴ City of Santa Rosa. 2019. Santa Rosa City Code. June.

Santa Rosa General Plan 2035

For the proposed project, the residential multi-family land use designations of the City's land use compatibility guidelines is applicable to the project. Table 5 lists the General Plan's land use compatibility standards applicable to the land use designation of residential multi-family.

Applicable goals and policies of the General Plan are summarized as follows:

- **NS-B-1:** Do not locate noise-sensitive uses in proximity to major noise sources, except residential is allowed near rail to promote future ridership.
- **NS-B-2:** Encourage residential developers to provide buffers other than sound walls, where practical. Allow sound walls only when projected noise levels at a site exceed the City's land use compatibility standards.
- **NS-B-3:** Prevent new stationary and transportation noise sources from creating a nuisance in existing developed areas. Use a comprehensive program of noise prevention through planning and mitigation, and consider noise impacts as a crucial factor in project approval.
- **NS-B-4:** Require new projects in the following categories to submit an acoustical study, prepared by a qualified acoustical consultant:
 - All new projects proposed for areas with existing noise above 60 dBA L_{dn} . Mitigation shall be sufficient to reduce noise levels below 45 dBA L_{dn} in habitable rooms and 60 dBA L_{dn} in private and shared recreational facilities. Additions to existing housing units are exempt.
 - All new projects that could generate noise whose impacts on other existing uses would be greater than those normally acceptable (as specified in the Land Use Compatibility Standards).
- **NS-B-5:** Pursue measures to reduce noise impacts primarily through site planning. Engineering solutions for noise mitigation, such as sound walls, are the least desirable alternative.
- **NS-B-6:** Do not permit existing uses to generate new noises exceeding normally acceptable levels unless:
 - Those noises are mitigated to acceptable levels; or
 - The activities are specifically exempted by the City Council on the basis of community health, safety, and welfare.
- **NS-B-8:** Adopt mitigations, including reduced speed limits, improved paving texture, and traffic controls, to reduce noise to normally acceptable levels in areas where noise standards may be exceeded (e.g., where homes front regional/arterial streets and in areas of mixed use development.)
- **NS-B-9:** Encourage developers to incorporate acoustical site planning into their projects. Recommended measures include:
 - Incorporating buffers and/or landscaped earth berms;
 - Orienting windows and outdoor living areas away from unacceptable noise exposure;
 - Using reduced-noise pavement (rubberized-asphalt);
 - Incorporating traffic calming measures, alternative intersection designs, and lower speed limits; and

- Incorporating state-of-the-art structural sound attenuation and setbacks.
- **NS-B-14:** Discourage new projects that have potential to create ambient noise levels more than 5 dBA L_{dn} above existing background, within 250 feet of sensitive receptors.

Table 5: Land Use Compatibility for Community Noise Exposure (dBA CNEL or L_{dn})

Land Use Category	55	60	65	70	75	80
Residential—Low-Density Single-Family, Duplex, and Mobile Homes	Light Blue					
		Blue				
				Dark Blue		
Residential—Multi-family	Light Blue					
		Blue				
				Dark Blue		
Transient Lodging—Motels, Hotels	Light Blue					
		Blue				
				Dark Blue		
Schools, Libraries, Churches, Hospitals, Nursing Homes	Light Blue					
		Blue				
				Dark Blue		
Auditoriums, Concert Halls, Amphitheaters	Light Blue					
		Blue				
			Dark Blue			
Sports Arenas, Outdoor Spectator Sports	Light Blue					
		Blue				
				Dark Blue		
Playgrounds, Neighborhood Parks	Light Blue					
			Blue			
				Dark Blue		

Land Use Category	55	60	65	70	75	80	
Golf Courses, Riding Stables, Water Recreation, Cemeteries	Normally Acceptable					Conditionally Acceptable	Normally Unacceptable
	Normally Acceptable					Conditionally Acceptable	Clearly Unacceptable
	Normally Acceptable					Conditionally Acceptable	Clearly Unacceptable
Office Buildings, Businesses, Commercial and Professional	Normally Acceptable				Conditionally Acceptable	Normally Unacceptable	
	Normally Acceptable				Conditionally Acceptable	Clearly Unacceptable	
	Normally Acceptable				Conditionally Acceptable	Clearly Unacceptable	
Industrial, Manufacturing, Utilities, Agriculture	Normally Acceptable					Conditionally Acceptable	Normally Unacceptable
	Normally Acceptable					Conditionally Acceptable	Clearly Unacceptable
	Normally Acceptable					Conditionally Acceptable	Clearly Unacceptable

Source: Santa Rosa General Plan 2035. 2009. Noise and Safety Element. November.

Key:

Normally Acceptable: Specified land use is satisfactory, based upon the assumption that any building involved is of normal conventional construction, without any special noise insulation requirements.
Conditionally Acceptable: New construction or development should be undertaken only after a detailed analysis of the noise reduction requirements is made and needed noise insulation features included in the design. Conventional construction, but with closed windows and fresh air supply systems or air conditioning will normally suffice.
Normally Unacceptable: New construction and development should generally be discouraged. If new construction or development does proceed, a detailed analysis of the noise reduction requirements must be made and needed noise insulation features included in the design.
Clearly Unacceptable: New construction or development should generally not be undertaken.

Santa Rosa Municipal Code

The City of Santa Rosa also addresses noise in the ordinances of the City Code. Santa Rosa Municipal Code Section 17-16.120, Machinery and Equipment, states that “it is unlawful for any person to operate any machinery, equipment, pump, fan, air-conditioning apparatus or similar mechanical device in any manner so as to create any noise, which would cause the noise level at the property line of any property to exceed the ambient base noise level by more than five decibels.”

Standard city conditions of project approval limit the hours of construction to 7:00 a.m. to 7:00 p.m., Monday through Friday, and 8:00 a.m. to 6:00 p.m. on Saturdays. No construction is permitted on Sundays and holidays.

THIS PAGE INTENTIONALLY LEFT BLANK

SECTION 4: THRESHOLDS OF SIGNIFICANCE AND IMPACT ANALYSIS

4.1 - Thresholds of Significance

According to California Environmental Quality Act (CEQA) Guidelines updated Appendix G, to determine whether impacts related to noise and vibration are significant environmental effects, the following questions are analyzed and evaluated.

It should be noted that the significance criteria question (a), below, is from the Land Use and Planning section of the CEQA Guidelines Appendix G checklist questions. However, this question addresses impacts related to conflicts with land use plans, which would include project-related conflicts to the noise land use compatibility standards of the Noise Element of the General Plan. Therefore, these impacts are addressed here.

Would the proposed plan:

- a) Cause a significant environmental impact due to a conflict with any land use plan, policy, or regulation adopted for the purpose of avoiding or mitigating an environmental effect?
- b) Generate a substantial temporary or permanent increase in ambient noise levels in the vicinity of the project in excess of standards established in the local general plan or noise ordinance, or applicable standards of other agencies?
- c) Generate excessive groundborne vibration or groundborne noise levels?
- d) For a project located within the vicinity of a private airstrip or an airport land use plan or, where such a plan has not been adopted, within two miles of a public airport or public use airport, would the project expose people residing or working in the project area to excessive noise levels?

4.2 - Noise Levels That Would Conflict with Any Land Use Plan, Policy, or Regulation

A significant impact would occur for the proposed project if the proposed multi-family residential land use development would be exposed to transportation noise levels in excess of applicable land use compatibility standards. The City considers environments with ambient noise levels of up to 65 dBA L_{dn} to be “normally acceptable” and for new multi-family residential land use development. Additionally, the interior noise levels for new multi-family residential land use development are not to exceed 45 dBA L_{dn} .

The project site is bound by West Steele Lane to the north, Meadowbrook Court to the west, commercial and retail uses to the north and east, and apartments and single-family residences to the south and west. While some of these surrounding land uses generate noise from typical parking lot activities and mechanical ventilation systems, the noise environment in the project vicinity is dominated by vehicle traffic noise on local roadways.

4.2.1 - Traffic Noise Compatibility

The City of Santa Rosa has documented traffic noise levels along select roadways throughout the City. According to the traffic noise contour data shown in Figure 12-2 of the City of Santa Rosa General Plan 2035 (see Exhibit 4), the project site lies within the 60 dBA L_{dn} traffic noise contours of U.S. Highway 101. However, this modeling data does not account for noise reduction due to terrain features or shielding from intervening structures. The project site lies over 2,100 feet from the edge of U.S. Highway 101, with multiple intervening structures between the project site and the highway. Therefore, it is a very conservative assumption to consider the project site to lie within the 60 dBA L_{dn} traffic noise contour of U.S. Highway 101.

Furthermore, the Santa Rosa General Plan 2035 Environmental Impact Report (EIR) documents traffic noise levels along West Steele Lane, between Marlow Road and Range Avenue, adjacent to the project site. According to Table 4.E-4 of this EIR, traffic noise levels are projected to range up to 60 dBA L_{dn} within 53 feet of the centerline of West Steele Lane, up to 65 dBA L_{dn} within 17 feet of the centerline of West Steele Lane, and up to 70 dBA L_{dn} within 5 feet of the centerline of West Steele Lane. The nearest proposed façade of the multi-family development project would be located approximately 40 feet from the centerline of West Steele Lane. At this distance traffic noise levels would be expected to range up to 62 dBA L_{dn} .

Therefore, reasonable worst-case combined traffic noise levels from U.S. Highway 101 (64 dBA L_{dn}) and West Steele Lane (62 dBA L_{dn}) could range up to 64 dBA L_{dn} on the project site. These traffic noise levels are within the City's normally acceptable land use compatibility threshold of below 65 dBA L_{dn} for new multi-family residential land use development. Therefore, the proposed project would not conflict with the City's noise land use compatibility standards.

Based on the EPA's Protective Noise Levels,⁵ with a combination of walls, doors, and windows, standard construction in accordance with building code requirements for multi-family residential developments would provide 25 dBA in exterior-to-interior noise reduction with windows closed and 15 dBA or more with windows open. With windows open, the interior noise levels of the proposed units nearest to and facing West Steele Lane would not meet the interior noise standard of 45 dBA L_{dn} for indoor sleeping areas (i.e., 64 dBA - 15 dBA = 49 dBA). However, the proposed multi-family residential buildings would include mechanical ventilation, which would allow windows to remain closed for prolonged periods of time, sufficiently reducing traffic noise levels to meet the interior noise level standard of 45 dBA L_{dn} (i.e., 64 dBA - 25 dBA = 39 dBA). Air conditioning units would give an occupant the option of controlling noise by keeping the windows shut. Therefore, the proposed project would not result in a conflict with the interior noise level standard of 45 dBA L_{dn} .

Therefore, the proposed project would not result in a conflict with applicable land use-noise compatibility guidelines and policies and traffic noise impacts to the proposed project to be less than significant.

⁵ United States Environmental Protection Agency (EPA) 550/9-79-100, November 1978.

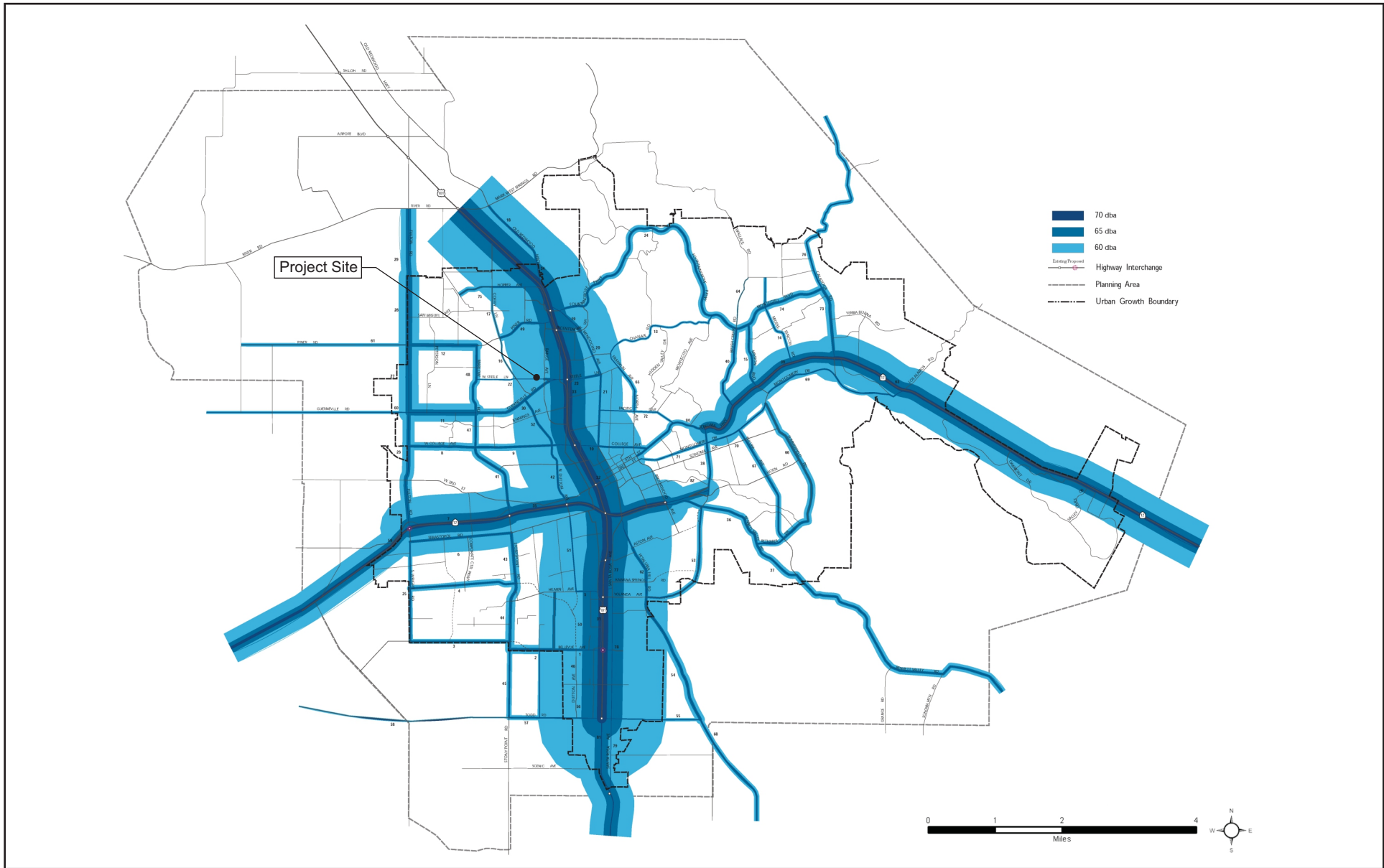

Source: City of Santa Rosa, 2020.

THIS PAGE INTENTIONALLY LEFT BLANK

4.3 - Substantial Noise Increase in Excess of Standards

A significant impact would occur if the proposed project would generate a substantial temporary or permanent increase in ambient noise levels in the project vicinity in excess of standards established in the local general plan or noise ordinance, or applicable standards of other agencies.

4.3.1 - Construction Noise Impacts

Short-Term Construction Impacts

For purposes of this analysis, a significant impact would occur if construction activities would result in a substantial temporary increase in ambient noise levels outside of the City's permissible hours for construction that would result in annoyance or sleep disturbance of nearby sensitive receptors. The City's permissible hours for construction activity is 7:00 a.m. to 7:00 p.m. Monday through Friday, and 8:00 a.m. to 6:00 p.m. on Saturdays; no construction is permitted on Sundays and holidays.

Construction-related Traffic Noise

Noise impacts from construction activities associated with the proposed project would be a function of the noise generated by construction equipment, equipment location, sensitivity of nearby land uses, and the timing and duration of the construction activities. One type of short-term noise impacts that could occur during project construction would result from the increase in traffic flow on local streets, associated with the transport of workers, equipment, and materials to and from the project site.

The transport of workers and construction equipment and materials to the project site would incrementally increase noise levels on access roads leading to the site. Because workers and construction equipment would use existing routes, noise from passing trucks would be similar to existing vehicle-generated noise on these local roadways. Typically, a doubling of the Average Daily Traffic (ADT) hourly volumes on a roadway segment is required in order to result in an increase of 3 dBA in traffic noise levels, which, as discussed in the characteristics of noise discussion above, is the lowest change that can be perceptible to the human ear in outdoor environments. Project-related construction trips would not be expected to double the hourly traffic volumes along any roadway segment in the project vicinity. For this reason, short-term intermittent noise from construction trips would be minor when averaged over a longer time-period and would not result in a perceptible increase in hourly- or daily-average traffic noise levels in the project vicinity. Therefore, short-term construction-related noise impacts associated with the transportation of workers and equipment to the project site would be less than significant.

Construction Equipment Operational Noise

The second type of short-term noise impact is related to noise generated during construction on the project site. Construction is completed in discrete steps, each of which has its own mix of equipment and, consequently, its own noise characteristics. These various sequential phases would change the character of the noise generated on the site and, therefore, the noise levels surrounding the site as construction progresses. Despite the variety in the type and size of construction equipment, similarities in the dominant noise sources and patterns of operation allow construction related noise

ranges to be categorized by work phase. Typical operating cycles for these types of construction equipment may involve 1 or 2 minutes of full-power operation followed by 3 or 4 minutes at lower power settings. Impact equipment, such as impact pile drivers, are not expected to be used during construction of this project.

The loudest phase of construction is typically the site preparation and grading phase as that is when the loudest pieces of heavy construction equipment would operate. For example, the maximum noise level generated by each scraper is assumed to be 85 dBA L_{max} at 50 feet from this equipment. Each bulldozer would also generate 85 dBA L_{max} at 50 feet. The maximum noise level generated by graders is approximately 85 dBA L_{max} at 50 feet.

A conservative but reasonable assumption is that this equipment would operate simultaneously and continuously over at least a 1-hour period in the vicinity of the closest existing residential receptors, but would move linearly over the project site as they perform their earth moving operations, spending a relatively short amount of time adjacent to any one receptor. A characteristic of sound is that each doubling of sound sources with equal strength increases a sound level by 3 dBA. Assuming that each piece of construction equipment operates at some distance from the other equipment, a reasonable worst-case combined noise level during this phase of construction would be 90 dBA L_{max} at a distance of 50 feet from the acoustic center of a construction area. The acoustical center reference is used because construction equipment must operate at some distance from one another on a project site, and the combined noise level as measured at a point equidistant from the sources (acoustic center) would be the worst-case maximum noise level. These operations would be expected to result in a reasonable worst-case hourly average of 86 dBA L_{eq} at a distance of 50 feet from the acoustic center of a construction area. These worst-case construction noise levels would only occur during the site preparation phase of development.

The nearest off-site receptor is a single-family residence located to the west of the project site, approximately 65 feet from the nearest acoustic center of construction activity where heavy construction equipment would operate during construction of the proposed project. At this distance, construction noise levels would range up to approximately 87.8 dBA L_{max} , with a relative worst-case hourly average of 83.8 dBA L_{eq} , if multiple pieces of heavy construction equipment operate simultaneously for an hour period at the nearest construction footprint.

Although there could be a relatively high single event noise exposure potential causing an intermittent noise nuisance, the effect of construction activities on longer-term (hourly or daily) ambient noise levels would be small but could result in a temporary increase in ambient noise levels in the project vicinity that could result in annoyance or sleep disturbance of nearby sensitive receptors. Therefore, limiting construction activities to the daytime hours would reduce the effects of noise levels produced by these activities on longer-term (hourly or daily) ambient noise levels, and would reduce potential impacts that could result in annoyance or sleep disturbances at nearby sensitive receptors. The City of Santa Rosa Municipal Code outlines the City's standards for noise-producing construction activities. According to this ordinance, construction and building repair activities are exempt from the applications of the Municipal Code between the hours of 7:00 a.m. and 7:00 p.m., Monday through Friday, and 8:00 a.m. to 6:00 p.m. on Saturdays. No construction is permitted on Sundays and holidays.

Therefore, restricting construction activities to these stated time periods, as well as implementing the Best Management Noise Reduction Practices listed below, would further ensure that construction noise impacts would not result in substantial temporary increases at the off-site sensitive receptors above standards established in the General Plan or Municipal Code, and construction noise impacts on sensitive receptors in the project vicinity would be less than significant.

Best Management Noise Reduction Practices

Implementation of the following multi-part mitigation measure is required to reduce potential construction period noise impacts:

- The construction contractor shall ensure that all equipment driven by internal combustion engines shall be equipped with mufflers, which are in good condition and appropriate for the equipment.
- The construction contractor shall ensure that unnecessary idling of internal combustion engines (i.e., idling in excess of 5 minutes) is prohibited.
- The construction contractor shall utilize “quiet” models of air compressors and other stationary noise sources where technology exists.
- At all times during project grading and construction, the construction contractor shall ensure that stationary noise-generating equipment shall be located as far as practicable from sensitive receptors and placed so that emitted noise is directed away from adjacent residences.
- The construction contractor shall ensure that the construction staging areas shall be located to create the greatest feasible distance between the staging area and noise-sensitive receptors nearest the project site.

4.3.2 - Mobile Source Operational Noise Impacts

A significant impact would occur if implementation of the proposed project would result in a substantial increase in traffic noise levels compared with traffic noise levels existing without the project. The City of Santa Rosa does define “substantial increase” for mobile noise sources. Therefore, for purpose of this analysis, a substantial increase is based on the following criteria. As noted in the characteristics of noise discussion, audible increases in noise levels generally refer to a change of 3 dBA or more, as this level has been found to be barely perceptible to the human ear in outdoor environments. Typically, a doubling of the ADT hourly volumes on a roadway segment is required in order to result in an increase of 3 dBA in traffic noise levels. Therefore, for purposes of this analysis, a doubling of the existing ADT volumes would result in a substantial permanent increase in traffic noise levels.

Based on the trip generation data from the ITE Manual,⁶ the project would generate an average of 264 trips per day, 20 AM peak-hour trips, and 24 PM peak-hour trips. These average daily and peak-

⁶ Institute of Transportation Engineers (ITE). 2018. Trip Generation Manual, 10th Edition.

hour project trips would not result in a doubling of the average daily trips along West Merrill Avenue or any other roadway segment in the project vicinity. Therefore, the increase in traffic noise resulting from project operations would not be perceptible along any roadway segment in the project vicinity. Therefore, implementation of the proposed project would not result in a substantial increase in traffic noise levels compared with traffic noise levels existing without the project.

4.3.3 - Stationary Source Operational Noise Impacts

The proposed project would include new stationary noise sources, such as typical parking lot activities and mechanical ventilation systems. A significant impact would occur if the proposed parking lot or mechanical ventilation systems exceed the City's noise performance standard. According to Section 17-16.120 of the City's Noise Ordinance, it is unlawful for any person to operate any machinery, equipment, pump, fan, air-conditioning apparatus or similar mechanical device in any manner so as to create any noise, which would cause the noise level at the property line of any property to exceed the ambient base noise level by more than 5 dBA. Furthermore, Policy NS-B-14 of the Noise Element of the General Plan discourages projects that have the potential to create ambient noise levels more than 5 dBA L_{dn} above the ambient base noise level.

Parking Lot Activities

The proposed project would provide a total of 36 parking stalls, including 5 surface parking spaces at the south yard and covered parking for 25 cars in a 2-level automated parking structure at the east side yard. The remaining 6 parking spaces are enclosed garage parking spaces.

According to the project site plans, surface parking spaces for the proposed multi-family residential units would be located approximately 65 feet of the nearest noise-sensitive receptor, the multi-family residential structure west of the project site. Representative surface parking activities, such as vehicles cruising at slow speeds, door slamming, or cars starting, would generate approximately 60 dBA to 70 dBA L_{max} at 50 feet. Typical parking events take an average of less than 1 minute.

The nearest noise-sensitive receptor is the multi-family residential structure located approximately 80-feet west of the nearest surface parking spaces. At this distance maximum noise levels from proposed surface parking activities would attenuate to approximately 65 dBA L_{max} as measured at the nearest façade of this multi-family residential structure. Assuming each of the surface parking spaces at the southern portion of the project site would incur one parking event in a maximum use hour, the combined parking lot activity would generate a reasonable worst-case hourly average noise level of up to 47 dBA L_{eq} as measured at this nearest sensitive receptor.

In addition to the surface parking, the proposed project would include covered parking for 25 cars in a 2-level automated parking structure at the east side yard. These parking spaces would be in the structure that would be enclosed on three sides and would be covered by a roof. The structure would provide shielding for the mechanical operational noise as well as the noise from car doors shutting. The nearest noise-sensitive receptor to the proposed parking structure is the multi-family residential structure located approximately 85-feet south of the parking structure. At this distance maximum noise levels from parking activities within the parking structure would attenuate to below

55 dBA L_{max} as measured at the nearest façade of this multi-family residential structure. Assuming each of the automated parking stalls would incur one parking event in a maximum use hour, the combined parking activity noise levels would generate a reasonable worst-case hourly average noise level of up to 38 dBA L_{eq} as measured at the nearest receptor.

As noted previously, existing background traffic noise levels from U.S. Highway 101 (64 dBA L_{dn}) and West Steele Lane (62 dBA L_{dn}) are documented to range up to 64 dBA L_{dn} on the project site. Therefore, parking lot activity noise levels would not exceed existing background ambient noise levels as measured at the nearest noise sensitive receptors and would not result in a substantial (+5 dBA) permanent increase in ambient noise levels in the project vicinity. The impact of project-related parking lot activities on sensitive off-site receptors would be less than significant.

Mechanical Equipment Operations

At the time of preparation of this analysis, details were not available pertaining to proposed mechanical ventilation systems for the project; therefore, a reference noise level for typical mechanical ventilation systems was used. Noise levels from typical residential mechanical ventilation equipment range from 50 dBA to 70 dBA L_{eq} at a distance of approximately 5 feet. Mechanical ventilation systems could be located as close as approximately 75 feet of the nearest off-site receptors. At this distance noise generated by mechanical ventilation equipment would attenuate to approximately 48 dBA L_{eq} at the nearest off-site residential receptors.

Therefore, when averaged over a 24-hour period, these mechanical ventilation equipment operational noise levels would also not exceed existing 24-hour average background noise levels. Therefore, mechanical ventilation system operational noise levels would not result in a substantial (+5 dBA) permanent increase in noise levels in excess of established standards and this impact would be less than significant. The impact of mechanical ventilation equipment operational noise levels on sensitive off-site receptors would be less than significant.

4.4 - Groundborne Vibration/Noise Levels

A significant impact would occur if the proposed project would generate excessive groundborne vibration or groundborne noise levels as measured at the nearest receptors.

Project-related construction and operational groundborne vibration impacts are analyzed separately below. Groundborne vibrations consist of rapidly fluctuating motions within the ground that have an average motion of zero. Vibrating objects in contact with the ground radiate vibration waves through various soil and rock strata to the foundations of nearby buildings.

In extreme cases, excessive groundborne vibration has the potential to cause structural damage to buildings. Common sources of groundborne vibration include construction activities such as blasting, pile driving, and operating heavy earthmoving equipment. In general, if groundborne vibration levels do not exceed levels considered to be perceptible, then groundborne noise levels would not be perceptible in most interior environments. Therefore, this analysis focuses on determining exceedances of groundborne vibration levels.

The City of Santa Rosa has not adopted a provision addressing the impacts of groundborne vibration levels. Therefore, for purposes of this analysis, the FTA's vibration impact criteria are utilized. The FTA has established industry accepted standards for vibration impact assessment in its Transit Noise and Vibration Impact Assessment Manual.⁷ These guidelines are summarized in Table 4.

4.4.1 - Short-term Construction Vibration Impacts

A significant impact would occur if the project construction activities would generate groundborne vibration levels in excess of levels established by the FTA's Construction Vibration Damage Criteria as measured at existing structures in the project vicinity.

Of the variety of equipment used during construction, the large vibratory rollers anticipated to be used in the site preparation phase of construction would produce the greatest groundborne vibration levels. Large vibratory rollers produce groundborne vibration levels ranging up to 0.210 inch per second (in/sec) PPV at 25 feet from the operating equipment.

The nearest off-site residential structure is located west of the project site across Meadowbrook Court, approximately 65 feet from the nearest construction footprint where large vibratory rollers would potentially operate. At this distance, groundborne vibration levels could range up to 0.05 PPV from operation of a large vibratory roller. This is well below the FTA's construction vibration damage criteria of 0.2 PPV for this type of structure—buildings of non-engineered timber and masonry construction.

The nearest commercial building is located southeast of the project site, approximately 25 feet from the nearest construction footprint where large vibratory rollers would potentially operate. At this distance, groundborne vibration levels could range up to 0.21 PPV from operation of a large vibratory roller. This is well below the FTA's construction vibration damage criteria of 0.3 PPV for this type of structure—buildings of engineered concrete and masonry construction.

Therefore, project construction activities would not generate groundborne vibration levels in excess of the FTA's criteria and impacts would be considered less than significant as measured at the nearest receiving structures in the project vicinity. Project construction related groundborne vibration impacts would be less than significant.

4.4.2 - Operational Vibration Impacts

Implementation of the proposed project would not include any permanent sources that would expose persons in the project vicinity to groundborne vibration levels that could be perceptible without instruments at any existing sensitive land use in the project vicinity. In addition, there are no existing significant permanent sources of groundborne vibration in the project vicinity. Therefore, project operations would not generate excessive groundborne vibration levels or expose proposed uses to excessive groundborne vibration levels, and groundborne vibration impacts would be less than significant.

⁷ Federal Transit Administration (FTA). 2018. Transit Noise and Vibration Impact Assessment Manual. September.

4.5 - Excessive Noise Levels from Airport Activity

A significant impact would occur if the proposed project would expose people residing or working in the project area to excessive noise levels for a project located within the vicinity of a private airstrip or an Airport Land Use Compatibility Plan or, where such a plan has not been adopted, within 2 miles of a public airport or public use airport.

The nearest airport to the project site is the Charles M. Schulz Sonoma County Airport located 4.75 miles northwest of the project site. Because of the distance from and orientation of the airport runways, the project site is located well outside of the 65 dBA CNEL airport noise contours. While aircraft noise is occasionally audible on the project site from aircraft flyovers, aircraft noise associated with nearby airport activity would not expose people residing or working near the project site to excessive noise levels. Therefore, implementation of the proposed project would not expose persons residing or working in the project vicinity to noise levels from airport activity that would be in excess of normally acceptable standards for multi-family residential land use development. Therefore, there would be no impact associated with airport noise.

THIS PAGE INTENTIONALLY LEFT BLANK

Appendix A:
Noise Modeling Data

THIS PAGE INTENTIONALLY LEFT BLANK

Parking Lot activity

Receptor: Closest Residence to the west

No.	Equipment Description	Reference (dBA)	Quantity	Usage factor[1]	Distance to Receptor	Ground Effect[2]	Shielding (dBA)[3]	Calculated (dBA)		Energy	
		50 ft Lmax						Lmax	Leq		
1	parking lot activity	70	1	1	80	1	0	65.9	43.9	24414.0625	
2	parking lot activity	70	1	1	105	1	0	63.6	40.3	10797.96998	
3	parking lot activity	70	1	1	130	1	0	61.7	37.6	5689.576695	
4	parking lot activity	70	1	1	175	1	0	59.1	33.7	2332.361516	
5	parking lot activity	70	1	1	200	1	0	58.0	31.9	1562.5	
6											
7											
8											
9											
10											
								Lmax[4]	66	Leq	47

Notes:

[1] Percentage of time activity occurs each hour

[2] Soft ground terrain between project site and receptor.

[3] Shielding due to terrain or structures

[4] Calculated Lmax is the Loudest value.

Receptor: Closest Residence to the south

No.	Equipment Description	Reference (dBA)	Quantity	Usage factor[1]	Distance to Receptor	Ground Effect[2]	Shielding (dBA)[3]	Calculated (dBA)		Energy	
		50 ft Lmax						Lmax	Leq		
1	parking lot activity	70	1	1	85	1	10	55.4	33.1	2035.416243	
2	parking lot activity	70	1	1	99	1	10	54.1	31.1	1288.26269	
3	parking lot activity	70	1	1	113	1	10	52.9	29.4	866.3127028	
4	parking lot activity	70	1	1	127	1	10	51.9	27.9	610.2374409	
5	parking lot activity	70	1	1	141	1	10	51.0	26.5	445.9156092	
6	parking lot activity	70	1	1	155	1	10	50.2	25.3	335.6718472	
7	parking lot activity	70	1	1	169	1	10	49.4	24.1	258.9702638	
8											
9											
10											
								Lmax[4]	55	Leq	38

Notes:

[1] Percentage of time activity occurs each hour

[2] Soft ground terrain between project site and receptor.

[3] Shielding due to terrain or structures

[4] Calculated Lmax is the Loudest value.

Land Use: 220 Multifamily Housing (Low-Rise)

Description

Low-rise multifamily housing includes apartments, townhouses, and condominiums located within the same building with at least three other dwelling units and that have one or two levels (floors). Multifamily housing (mid-rise) (Land Use 221), multifamily housing (high-rise) (Land Use 222), and off-campus student apartment (Land Use 225) are related land uses.

Additional Data

In prior editions of *Trip Generation Manual*, the low-rise multifamily housing sites were further divided into rental and condominium categories. An investigation of vehicle trip data found no clear differences in trip making patterns between the rental and condominium sites within the ITE database. As more data are compiled for future editions, this land use classification can be reinvestigated.

For the three sites for which both the number of residents and the number of occupied dwelling units were available, there were an average of 2.72 residents per occupied dwelling unit.

For the two sites for which the numbers of both total dwelling units and occupied dwelling units were available, an average of 96.2 percent of the total dwelling units were occupied.

This land use included data from a wide variety of units with different sizes, price ranges, locations, and ages. Consequently, there was a wide variation in trips generated within this category. Other factors, such as geographic location and type of adjacent and nearby development, may also have had an effect on the site trip generation.

Time-of-day distribution data for this land use are presented in Appendix A. For the 10 general urban/suburban sites with data, the overall highest vehicle volumes during the AM and PM on a weekday were counted between 7:15 and 8:15 a.m. and 4:45 and 5:45 p.m., respectively. For the one site with Saturday data, the overall highest vehicle volume was counted between 9:45 and 10:45 a.m. For the one site with Sunday data, the overall highest vehicle volume was counted between 11:45 a.m. and 12:45 p.m.

For the one dense multi-use urban site with 24-hour count data, the overall highest vehicle volumes during the AM and PM on a weekday were counted between 7:00 and 8:00 a.m. and 6:15 and 7:15 p.m., respectively.

For the three sites for which data were provided for both occupied dwelling units and residents, there was an average of 2.72 residents per occupied dwelling unit.

The average numbers of person trips per vehicle trip at the five general urban/suburban sites at which both person trip and vehicle trip data were collected were as follows:

- 1.13 during Weekday, Peak Hour of Adjacent Street Traffic, one hour between 7 and 9 a.m.
- 1.21 during Weekday, Peak Hour of Adjacent Street Traffic, one hour between 4 and 6 p.m.

The sites were surveyed in the 1980s, the 1990s, the 2000s, and the 2010s in British Columbia (CAN), California, District of Columbia, Florida, Georgia, Illinois, Indiana, Maine, Maryland, Minnesota, New Jersey, New York, Ontario, Oregon, Pennsylvania, South Dakota, Tennessee, Texas, Utah, Virginia, and Washington.

It is expected that the number of bedrooms and number of residents are likely correlated to the number of trips generated by a residential site. Many of the studies included in this land use did not indicate the total number of bedrooms. To assist in the future analysis of this land use, it is important that this information be collected and included in trip generation data submissions.

Source Numbers

168, 187, 188, 204, 211, 300, 305, 306, 319, 320, 321, 357, 390, 412, 418, 525, 530, 571, 579, 583, 864, 868, 869, 870, 896, 903, 918, 946, 947, 948, 951

Multifamily Housing (Low-Rise) (220)

Vehicle Trip Ends vs: Dwelling Units
On a: Weekday

Setting/Location: General Urban/Suburban
Number of Studies: 29
Avg. Num. of Dwelling Units: 168
Directional Distribution: 50% entering, 50% exiting

Vehicle Trip Generation per Dwelling Unit

Average Rate	Range of Rates	Standard Deviation
7.32	4.45 - 10.97	1.31

Multifamily Housing (Low-Rise) (220)

Vehicle Trip Ends vs: Dwelling Units
On a: Weekday,
Peak Hour of Adjacent Street Traffic,
One Hour Between 4 and 6 p.m.

Setting/Location: General Urban/Suburban
Number of Studies: 50
Avg. Num. of Dwelling Units: 187
Directional Distribution: 63% entering, 37% exiting

Vehicle Trip Generation per Dwelling Unit

Average Rate	Range of Rates	Standard Deviation
0.56	0.18 - 1.25	0.16

Multifamily Housing (Low-Rise) (220)

Vehicle Trip Ends vs: Dwelling Units
On a: Weekday,
AM Peak Hour of Generator

Setting/Location: General Urban/Suburban
 Number of Studies: 36
 Avg. Num. of Dwelling Units: 161
 Directional Distribution: 28% entering, 72% exiting

Vehicle Trip Generation per Dwelling Unit

Average Rate	Range of Rates	Standard Deviat
0.56	0.34 - 0.97	0.15

Multifamily Housing (Low-Rise) (220)

Vehicle Trip Ends vs: Dwelling Units
On a: Weekday,
PM Peak Hour of Generator

Setting/Location: General Urban/Suburban
 Number of Studies: 35
 Avg. Num. of Dwelling Units: 146
 Directional Distribution: 59% entering, 41% exiting

Vehicle Trip Generation per Dwelling Unit

Average Rate	Range of Rates	Standard Deviat
0.67	0.41 - 1.25	0.14

PROJECT TRIP CALCULATION

	Trip Rate	# Dwelling Units	Total Trips
Weekday	7.32	36	264
AM Peak Hour	0.56	36	20
PM Peak Hour	0.67	36	24



March 30, 2020

Mr. Patrick O'Neill
McBride Lane Apartments LLC
19 Leona Drive
San Rafael, CA 94903

Traffic Study for the 1650 Steele Lane Project

Dear Mr. O'Neill;

As requested, W-Trans has prepared a focused traffic study for the proposed residential development at 1650 Steele Lane in the City of Santa Rosa. The purpose of this letter is to address the potential traffic impacts associated with the proposed multifamily residential development.

Project Description

The proposed project would include construction of a three-story 36-unit housing apartment complex including four affordable units on a vacant lot at 1650 Steele Lane in the City of Santa Rosa. The site would be accessible via a proposed driveway to be constructed on the southern end of the project site off Meadowbrook Court. There would be 36 vehicle parking spaces provided on-site.

Circulation Setting

Vehicular Circulation

The study area consists of Steele Lane and Meadowbrook Court, which run along the frontages of the project site.

Steele Lane is generally oriented east-west and is classified as a major collector. Along the project frontage the road has one 12-foot travel lane and a bicycle lane in each direction; the posted speed limit is 35 mph.

Meadowbrook Court is a cul-de-sac in a north-south orientation classified as a residential street. The two-lane street has a posted speed limit of 25 mph.

Pedestrian Facilities

Pedestrian facilities include sidewalks, crosswalks, pedestrian signal phases, curb ramps, curb extensions, and various streetscape amenities such as lighting, benches, etc. Continuous sidewalks are present along the project frontage on Steele Lane, connected to a curb ramp at the project corner with Meadowbrook Court. There are no sidewalks along the project frontage on Meadowbrook Court to connect to existing sidewalks on Steele Lane and on Meadowbrook Court south of the project site nor are there sidewalks on the west side of Meadowbrook Court opposite the project site. There is no street lighting on Meadowbrook Court near the project site.

Bicycle Facilities

There are bicycle lanes on Steele Lane between Marlow Road and Range Avenue, as well as on Range Avenue between Russell Avenue and Steele Lane. According to the *City of Santa Rosa Bicycle and Pedestrian Master Plan 2018 Update*, 2019, the existing SMART trail is proposed to be extended north between Guerneville Road and north of the City limits. Additionally, existing bicycle lanes on Range Avenue would be extended south to Jennings Avenue. Sharrows are proposed along Hardies Lane between Steele Lane and Russell Avenue.

Transit Facilities

The closest bus stop from the project is approximately 200 feet to the near Range Avenue. The project site is within the quarter-mile walking distance considered an acceptable walking distance to transit of Santa Rosa CityBus Routes 1, 6 and 10, Mendocino Transit Authority (MTA) Route 95, and Sonoma County Transit (SCT) Routes 20, 30, 44, 48, 54, and 57. These routes provide connectivity from the site throughout the City of Santa Rosa, within the County of Sonoma, and to adjacent Mendocino County. The project site is within one-half mile of both the Santa Rosa North SMART Station and the Copeland Transit Mall. SMART provides access between North Santa Rosa and Larkspur Landing where a connection can be made by ferry to San Francisco. According to the *City of Santa Rosa Bicycle and Pedestrian Master Plan 2018 Update*, existing bicycle lanes on Range Avenue are proposed to be extended south, which would connect the project site between existing bicycle lanes on Steele Lane and Guerneville Road to the Copeland Mall and the Santa Rosa North SMART Station.

Two bicycles can be carried on most CityBus, SCT, and MTA buses. Bike rack space is a first come first served basis. Additional bicycles are allowed on these buses as the discretion of the driver.

Dial-a-ride, also known as paratransit, or door-to-door service, is available for those who are unable to independently use the transit system due to a physical or mental disability. This service is available through CityBus and SCT. The service is designed to serve the needs of individuals with disabilities within Santa Rosa area and includes area within a three-quarters of a mile from an active CityBus or SCT route.

Trip Generation

The anticipated trip generation for the proposed project was estimated using standard rates published by the Institute of Transportation Engineers (ITE) in *Trip Generation Manual*, 10th Edition, 2017 for a Multifamily Housing (Low-Rise) (Land Use #220). Based on application of these rates, the proposed project is expected to generate an average of 264 trips per day, including 17 a.m. peak hour trips and 20 trips during the p.m. peak hour. These results are summarized in Table 1.

Table 1 – Proposed Trip Generation Summary

Land Use	Units	Daily		AM Peak Hour				PM Peak Hour			
		Rate	Trips	Rate	Trips	In	Out	Rate	Trips	In	Out
Apartments	36 du	7.32	264	0.46	17	4	13	0.56	20	13	7

Note: du = dwelling unit

Because the project is expected to generate fewer than 50 peak hour trips, only a focused study is required under the *City's Guidance for the Preparation of Traffic Operational Analysis*, 2019.

Site Access

As part of the construction of the project, a driveway would be constructed off Meadowbrook Court at the southern side of the project site.

Emergency Vehicle Access

Based on the site plan dimensions, on-site circulation is adequate for emergency vehicle access, such as fire trucks and ambulances. There is a fire hydrant at the corner of Steele Lane/Meadowbrook Court. Auto-turn exhibits of a fire truck maneuvering on-site is enclosed.

Sight Distance

Sight distances along Meadowbrook Court at the proposed new driveway were evaluated based on sight distance criteria contained in the *Highway Design Manual*, 6th Edition published by Caltrans. The recommended sight distances along the Meadowbrook Court at the private project driveway are based on stopping sight distance.

Based on a design speed of 25 mph, the minimum stopping sight distance needed is 150 feet. During the site visit, there was a vehicle parked where the proposed driveway would be, and sight distance was limited due to vehicles parked on either side of the proposed driveway. To ensure adequate sight lines, it is recommended that the curb be painted red on either side of the driveway for a length of 22 feet, or one standard vehicle length. Additionally, it is recommended that any signage or landscaping planned at the driveway be outside of the driver's vision triangle to maintain adequate sight lines.

Finding – Sight distance based on the posted speed limit at the proposed driveway was limited due to parked vehicles.

Recommendation – Parking should be prohibited through use of red-painted curb for 22 feet, or the length of one standard parking space, on either side of the project driveway to ensure adequate sight distance. Additionally, the project should be designed to keep any project signage or landscaping outside of the driver's vision triangle.

Left-Turn Lane Warrant

The need for a left-turn lane on Steele Lane at Meadowbrook Court was evaluated based on criteria contained in the *Intersection Channelization Design Guide*, National Cooperative Highway Research Program (NCHRP) Report No. 279, Transportation Research Board, 1985, as well as an update of the methodology developed by the Washington State Department of Transportation and published in the *Method For Prioritizing Intersection Improvements*, January 1997.

Existing peak hour volumes at Steele Lane/Range Avenue as well as safety criteria were used. The trip generation for the existing single-family and multifamily units that are accessible via Meadowbrook Court were assumed based on City GIS parcel maps, and 62 multifamily units and two single family units were assumed. Based on counts along Steele Lane, it was assumed 60 percent of trips would travel to and from Meadowbrook Court from the east and 40 percent to and from the west. Under Existing plus Project conditions, which includes traffic associated with the existing residential units that are accessible via Meadowbrook Court and the proposed project, a left-turn lane is **not** warranted on Steele Lane at Meadowbrook Court during either of the peak periods evaluated. The left-turn lane warrant spreadsheets and counts used are enclosed for reference.

Non-Auto Modes

Pedestrian Facilities

Given the proximity of the Coddington Mall and rapid bus stops within one-half mile surrounding the site, it is anticipated that some project residents will want to walk, bicycle, and/or use transit for trips from and to the project site. The site plan includes plans for construction of sidewalk and landscape buffering on the project frontage on Meadowbrook Court, which will provide a connection between existing sidewalks south of the project site and on Steele Lane. The inclusion of a landscape buffer results in an indirect connection to the existing sidewalk to the south of the site. Because buffers are typically not required on minor streets it appears that the landscape buffer could be eliminated. If it is to be retained it should be tapered at the south end of the site so that there is a smoother transition to the existing sidewalk.

The existing curb ramp on the project corner of Meadowbrook Court/Steele Lane would be reconstructed to match the new curblines along Meadowbrook Court after widening the street along the project frontage by four feet. Additionally, the site plan includes a streetlight just south of Steele Lane on Meadowbrook Court.

The existing sidewalk on Steele Lane along the project frontage will be reconstructed and the existing driveway on Steele Lane on the project frontage would be closed and converted to sidewalk.

Finding – Planned sidewalks and street lighting along Meadowbrook Court, along with existing facilities, are adequate for anticipated demand and will improve connectivity from existing conditions.

Recommendation – Either the sidewalk along the project frontage should be contiguous with the curb and gutter or the transition at the south end should be tapered to provide a more standard and comfortable connection to the existing sidewalk on the southern end of Meadowbrook Court.

Bicycle Facilities

Existing bicycle facilities, including bike lanes on Steele Lane, together with shared use of minor streets, provide adequate access for bicyclists. The proposed addition of bicycle lanes along some of the streets surrounding the project site as well as extension of the SMART trail north of the Santa Rosa North Station will provide adequate access for bicyclists.

Finding – Bicycle facilities serving the project are adequate and will be improved with the planned completion of additional facilities in the future.

Transit Facilities

Existing transit routes are acceptable to accommodate project-generated transit trips. Existing bus stops are within an acceptable walking distance of the site, and accessible via sidewalks.

Finding – Transit facilities serving the project site are adequate.

Vehicular Parking

The proposed project would provide 36 off-street parking spaces. The City of Santa Rosa's City Code stipulates the City's parking requirements for new developments. According to Zoning Code Section 20-36.050, "Parking requirements for projects located within the Downtown and North Santa Rosa Station Area Specific Plan boundaries may be reduced by the review authority, as a condition of project approval or Minor Conditional Use Permit, when supported by a parking study." Because the project site is within the *North Santa Rosa Station Area Specific Plan* boundary, the parking requirement for the 32 market-rate units of 1.5 spaces per unit is lower than for general multifamily dwelling units. Additionally, the four affordable units would have a required parking rate of one space per unit. Based on the applicable parking requirements, the proposed project would need 52 parking spaces, or 16 spaces more than are proposed. According to the City Code, "The review authority may approve a decrease in parking spaces after first making the following finding: (C)(2)(a) The number of parking spaces approved will be sufficient for its safe, convenient and efficient operation of the use, and will be compatible with the neighboring properties." Since the proposed parking supply is deficient to meet City requirements, the project's potential parking demand was evaluated.

Standard parking demand rates published by ITE in *Parking Generation*, 5th Edition, 2019 were applied to the proposed project. Since the project site is within one-half mile of the SMART station and within walking distance of the Coddington Mall and Transit Center, the land use "Multifamily Residential Housing (Low-Rise) in a Dense Multi-Use Urban Area within One-Half Mile of Rail Transit" (LU 220) was applied. Based on ITE rates, the 36-unit

project would generate a peak parking demand of 39 parking spaces, which is three spaces more than the proposed parking supply, but 13 spaces fewer than required based on application of City code.

It is noted that the proposed project includes plans to provide unbundled parking, which could decrease parking demand and provide a cost saving to tenants. This makes parking a separate option in lease agreements and allows residents to choose if they want to lease a parking space or not. Residential parking spaces are typically bundled into the lease amounts, so residents may not realize the high cost of building, operating, and maintaining parking. Further, adding parking as a separate line item will help tenants understand the cost savings associated with reducing their parking needs. This parking demand strategy is estimated to reduce parking demand by 10 to 15 percent based on the Metropolitan Transportation Commission (MTC)'s *Reforming Parking Policies to Support Smart Growth*. To be conservative, applying the lower potential parking demand percentage decrease from unbundled parking (10 percent) the project would generate four fewer spaces than compared to ITE rates, for a total peak parking demand of 35 spaces. Compared to the proposed parking supply, the parking demand would be one less space than proposed with unbundled parking deductions applied.

Finding – Based on City requirements, the proposed parking supply would be deficient by 16 spaces. However, given the site's proximity to rail transit, application of ITE standard parking demand rates together with the project's proposed use of unbundled parking, the anticipated peak parking demand would be one space less than the proposed supply. Under these assumptions, the proposed parking supply would be expected to be adequate to meet the project's demand.

Bicycle Parking

According to the City Code, the project would be required to provide bicycle parking spaces at a rate of one space per four units unless units have a private garage or storage space for a bicycle. Based on the proposed number of units, the project would be required to provide at least nine bicycle parking spaces. As proposed, there would be nine long-term spaces and nine bicycle rack spaces, for a total of 18 bicycle parking spaces on-site; this would be more than adequate to meet City requirements. As the proposed supply of bicycle parking spaces is double the number required based on City requirements, it is anticipated that this would encourage the use of active modes of transportation rather than vehicular ownership, further reducing parking demand associated with the project.

Conclusions and Recommendations

- As proposed, the project would generate 264 trips daily, including 17 trips in the a.m. peak hour and 20 trips during the p.m. peak hour.
- Emergency vehicle access would be adequate.
- Sight lines at the proposed driveway location would be limited by vehicles parked on the project side of Meadowbrook Court. It is recommended that the curb be painted red for 22 feet, or one parking space length, on either side of the project driveway to ensure adequate sight lines. Additionally, any project landscaping and signage at the driveway should be placed outside the driver's vision triangle.
- A left-turn lane would not be warranted on Steele Lane at Meadowbrook Court, with or without project generated trips.
- With the construction of the proposed project, existing sidewalks on the project frontage on Steele Lane would be improved, and the existing driveway eliminated. New sidewalk would be constructed on the Meadowbrook Court frontage. It is recommended that this sidewalk be placed contiguous to the curb and

gutter to match facilities to the south or else realigned at the southerly end of the site to provide a transition to the connection with existing facilities.

- Existing bicycle and transit facilities serving the site are adequate.
- The proposed supply of vehicle parking spaces is deficient by 16 spaces compared to City requirements; however, it is adequate to meet the peak demand projected by applying standard parking demand rates combined with reductions in demand due to unbundled parking. The number of bicycle parking spaces on-site as proposed is double the number needed to meet City requirements, which would be expected to contribute to lower vehicle ownership.

Thank you for giving W-Trans the opportunity to provide these services. Please call if you have any questions.

Sincerely,

Julia Walker
Assistant Planner

Dalene J. Whitlock, PE, PTOE
Senior Principal

DJW/jaw/SRO547.L1

Enclosures: Site Plan; Auto-Turn Exhibit; Left-Turn Lane Warrant Spreadsheets; Counts

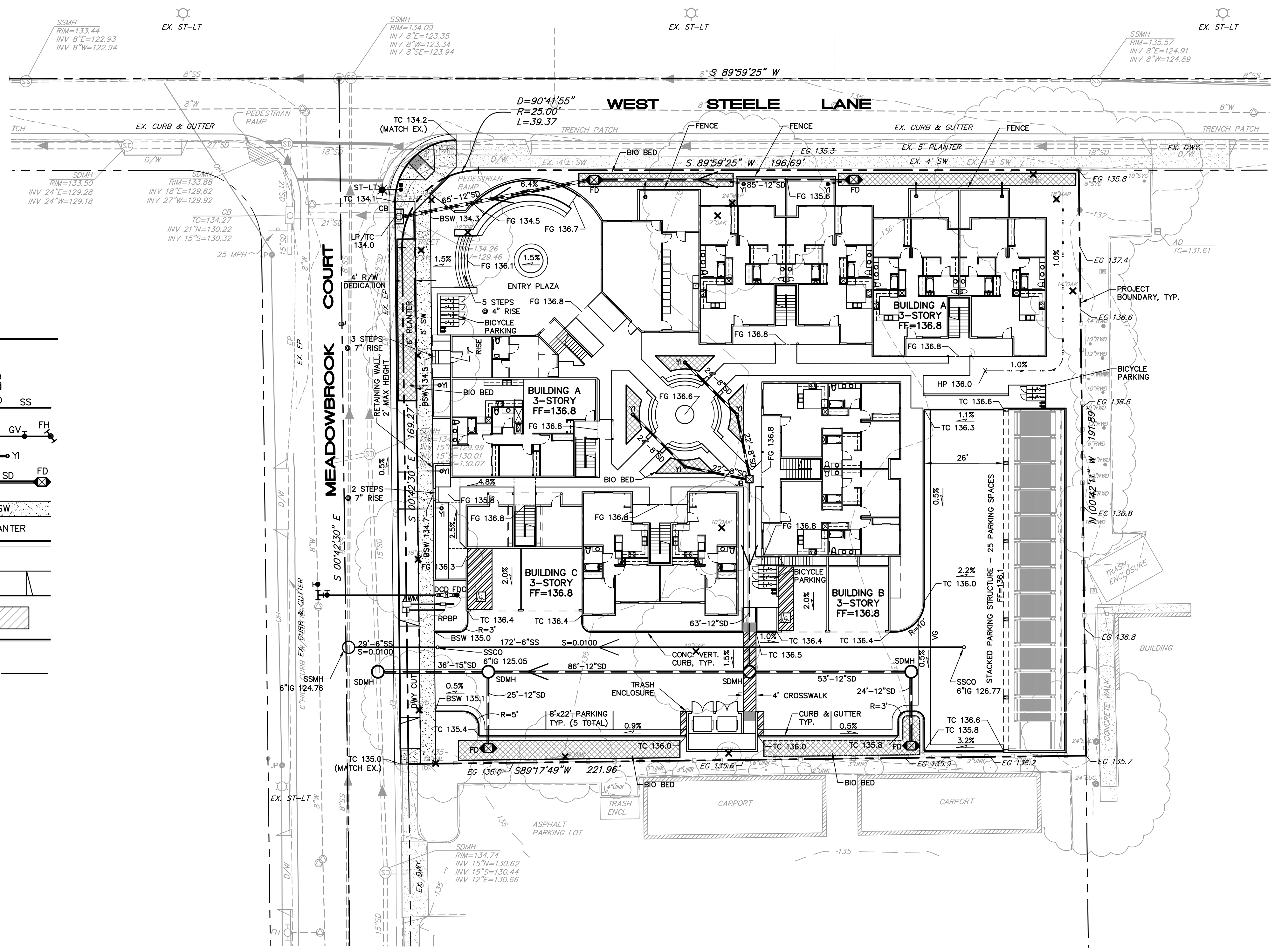
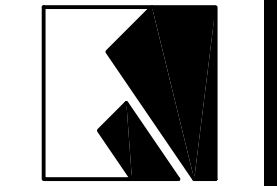

LEGEND

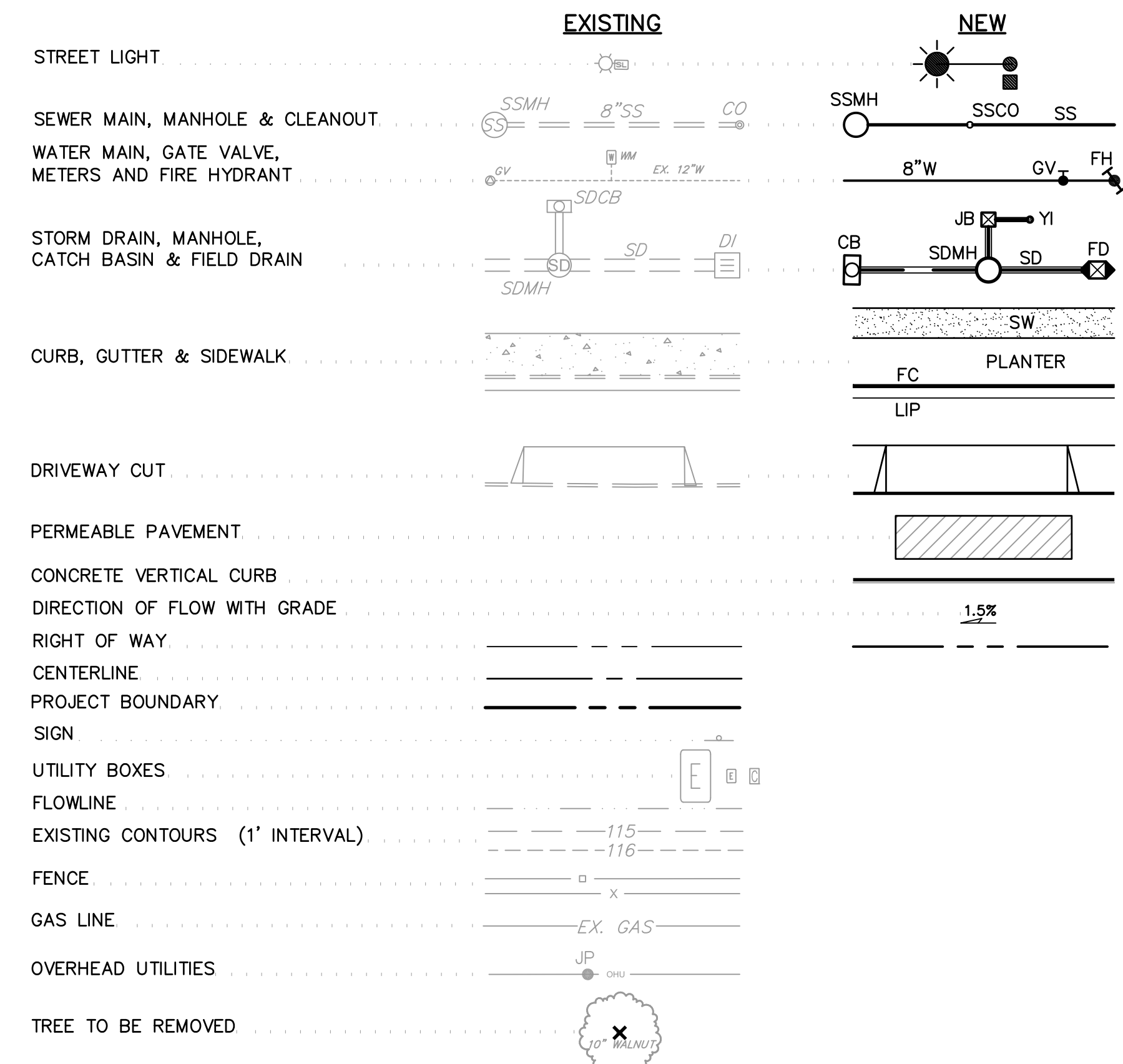

ABBREVIATIONS

ADA	AMERICANS WITH DISABILITIES ACT
APN	ASSESSORS PARCEL NUMBER
BSW	BACK OF SIDEWALK
CB	CATCH BASIN
CONC	CONCRETE
DCD	DOUBLE CHECK DETECTOR
DN	DOCUMENT NUMBER
EG	EXISTING GRADE
EP	EDGE OF PAVEMENT
EX	EXISTING
FD	FIELD DRAIN
FDC	FIRE DEPARTMENT CONNECTION
FF	FINISH FLOOR
FG	FINISH GRADE
FH	FIRE HYDRANT
FL	FLOW LINE
GV	GATE VALVE
HP	HIGH POINT
IG	INVERT GRADE
JB	JUNCTION BOX
LP	LOW POINT
R	RADIUS
R/W	RIGHT OF WAY
RPBP	REDUCED PRESSURE BACKFLOW PREVENTOR
S	SLOPE OR SOUTH
SDMH	STORM DRAIN MANHOLE
SO	SIDE OPENING
SS	SANITARY SEWER
SSCO	SANITARY SEWER CLEAN OUT
SSMH	SANITARY SEWER MANHOLE
ST-LT	STREET LIGHT
SW	SIDEWALK
SWE	SIDEWALK EASEMENT
TC	TOP OF CURB
TYP	TYPICAL
VERT	VERTICAL
VG	VALLEY GUTTER
W	WATER OR WEST
WM	WATER METER
YI	YARD INLET

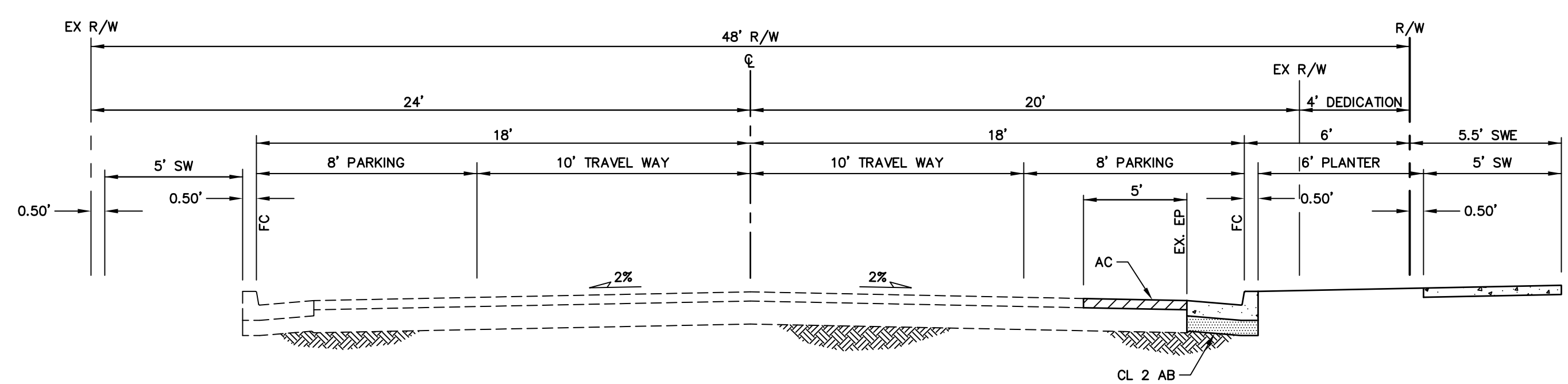

MINOR STREET - PUBLIC
MEADOWBROOK COURT

NO SCALE

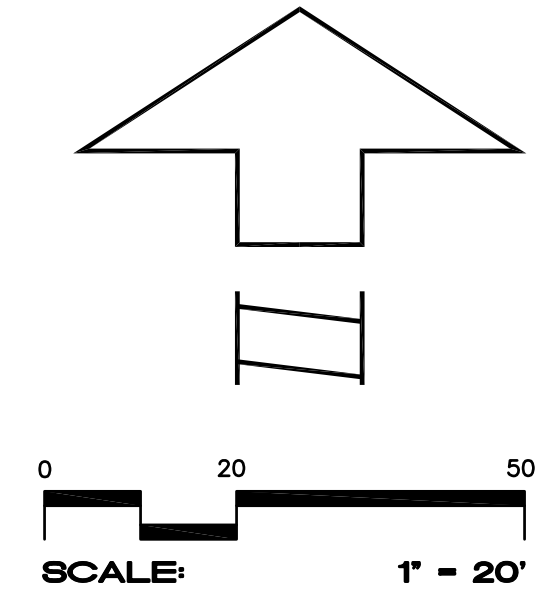

S:\2019\PROJ\19-107\Drawings\Site\Grading\SSMH\SSMH-01.dwg 11/15/2019 10:56:08 AM

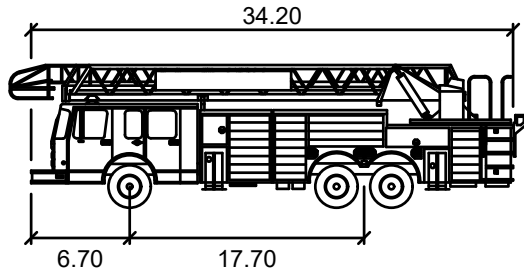

FIRE-LADDER

- Width : 8.20
- Track : 8.20
- Lock to Lock Time : 6.0
- Steering Angle : 36.8

feet

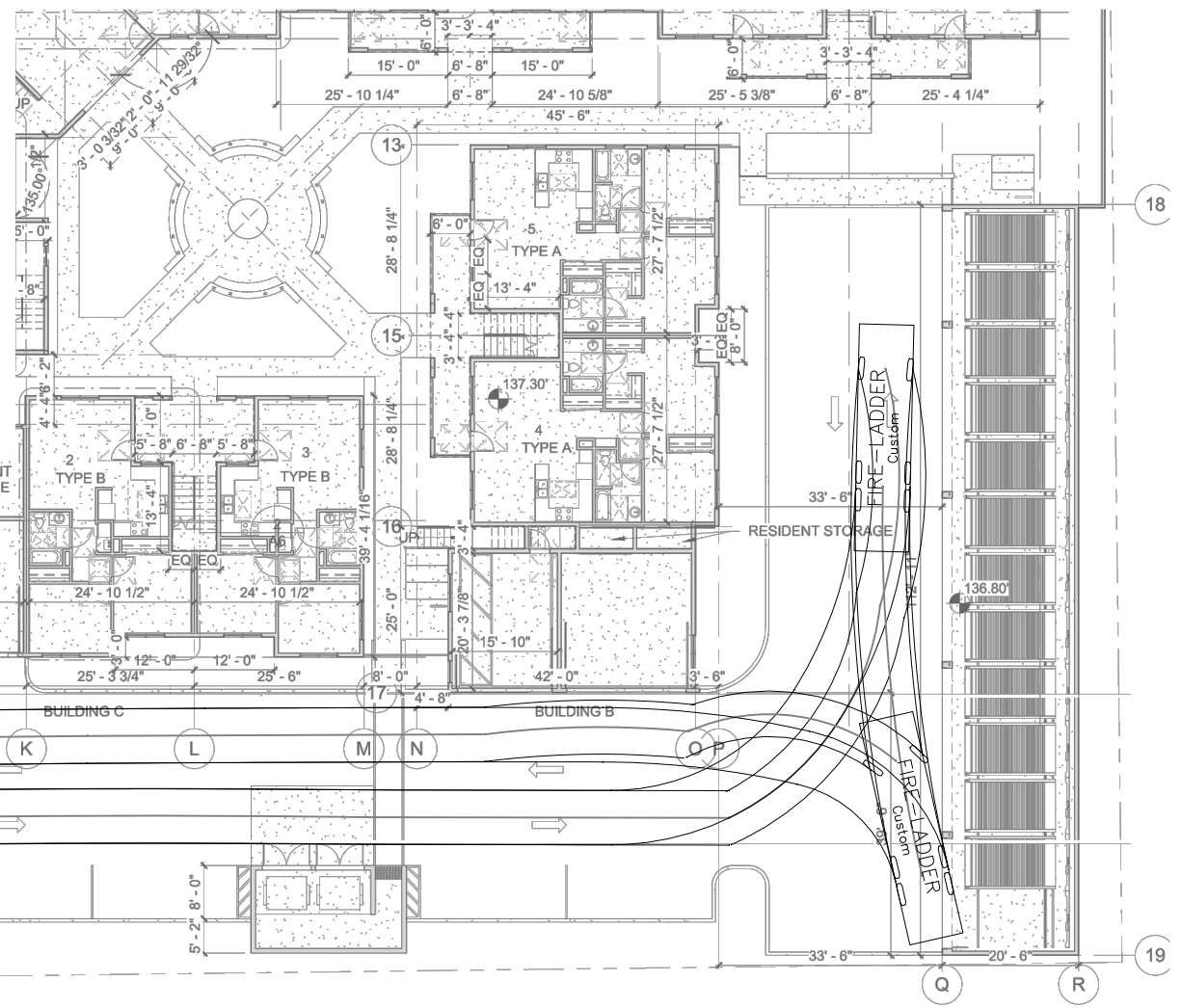

Turn Lane Warrant Analysis - Tee Intersections

Study Intersection: Steele Lane/Meadowbrook Court
 Study Scenario: AM Existing

Direction of Analysis Street: East/West

Cross Street Intersects: From the South

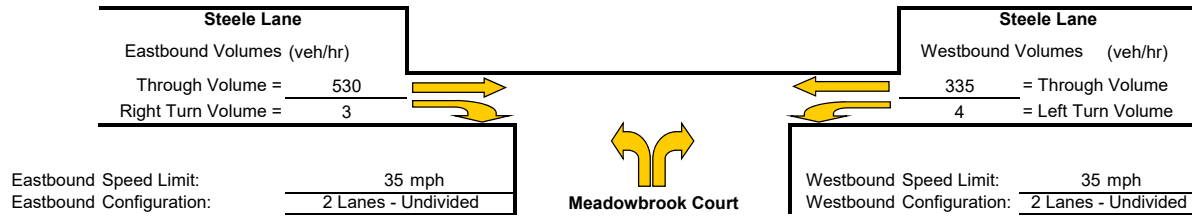

Eastbound Right Turn Lane Warrants

1. Check for right turn volume criteria

Thresholds not met, continue to next step

2. Check advance volume threshold criteria for turn lane

Advancing Volume Threshold AV = 1027.6
 Advancing Volume Va = 533
 If $AV < Va$ then warrant is met No

Right Turn Lane Warranted: NO

Eastbound Right Turn Taper Warrants

(evaluate if right turn lane is unwarranted)

1. Check taper volume criteria

NOT WARRANTED - Less than 20 vehicles

2. Check advance volume threshold criteria for taper

Advancing Volume Threshold AV = -
 Advancing Volume Va = 533
 If $AV < Va$ then warrant is met -

Right Turn Taper Warranted: NO

Westbound Left Turn Lane Warrants

Percentage Left Turns %lt 1.2 %
 Advancing Volume Threshold AV 1025 veh/hr
 If $AV < Va$ then warrant is met

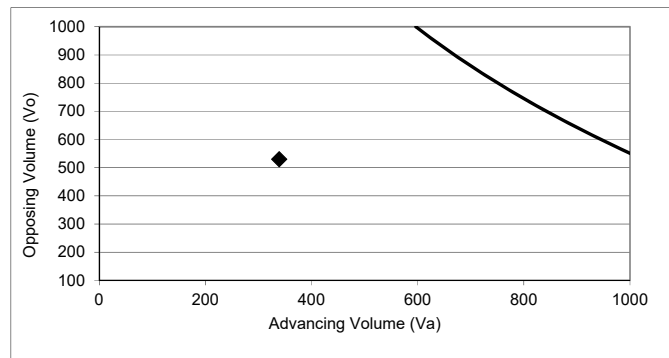

◆ Study Intersection

Two lane roadway warrant threshold for: 35 mph

Turn lane warranted if point falls to right of warrant threshold line

Left Turn Lane Warranted: NO

Methodology based on Washington State Transportation Center Research Report *Method For Prioritizing Intersection Improvements*, January 1997.

The right turn lane and taper analysis is based on work conducted by Cottrell in 1981.

The left turn lane analysis is based on work conducted by M.D. Harmelink in 1967, and modified by Kikuchi and Chakroorty in 1991.

Turn Lane Warrant Analysis - Tee Intersections

Study Intersection: Steele Lane/Meadowbrook Court

Study Scenario: AM Existing plus Project

Direction of Analysis Street: East/West

Cross Street Intersects: From the South

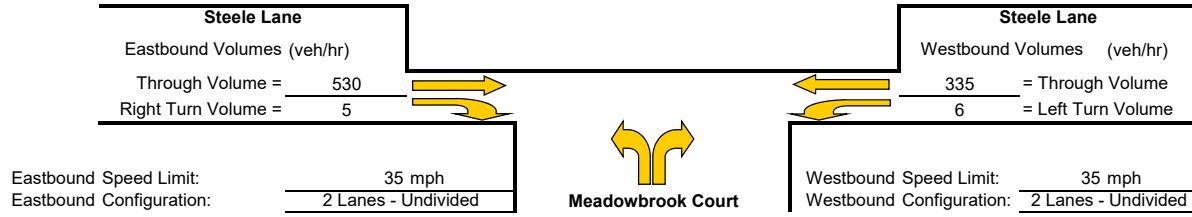

Eastbound Right Turn Lane Warrants

1. Check for right turn volume criteria

Thresholds not met, continue to next step

2. Check advance volume threshold criteria for turn lane

Advancing Volume Threshold AV = 1012.6
 Advancing Volume Va = 535
 If $AV < Va$ then warrant is met No

Right Turn Lane Warranted: NO

Eastbound Right Turn Taper Warrants

(evaluate if right turn lane is unwarranted)

1. Check taper volume criteria

NOT WARRANTED - Less than 20 vehicles

2. Check advance volume threshold criteria for taper

Advancing Volume Threshold AV = -
 Advancing Volume Va = 535
 If $AV < Va$ then warrant is met -

Right Turn Taper Warranted: NO

Westbound Left Turn Lane Warrants

Percentage Left Turns %lt 1.8 %
 Advancing Volume Threshold AV 942 veh/hr
 If $AV < Va$ then warrant is met

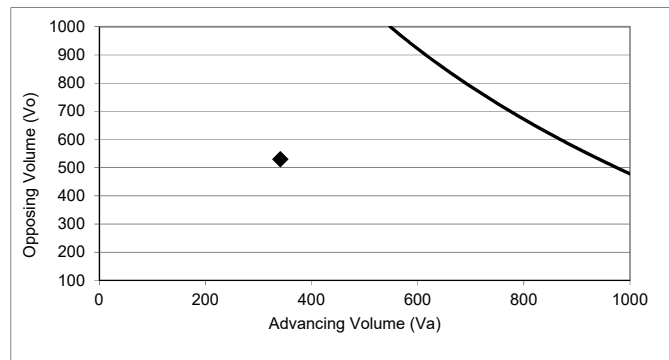

◆ Study Intersection

Two lane roadway warrant threshold for: 35 mph

Turn lane warranted if point falls to right of warrant threshold line

Left Turn Lane Warranted: NO

Methodology based on Washington State Transportation Center Research Report *Method For Prioritizing Intersection Improvements*, January 1997.

The right turn lane and taper analysis is based on work conducted by Cottrell in 1981.

The left turn lane analysis is based on work conducted by M.D. Harmelink in 1967, and modified by Kikuchi and Chakroborty in 1991.

Turn Lane Warrant Analysis - Tee Intersections

Study Intersection: Steele Lane/Meadowbrook Court

Study Scenario: PM Existing

Direction of Analysis Street: East/West

Cross Street Intersects: From the South

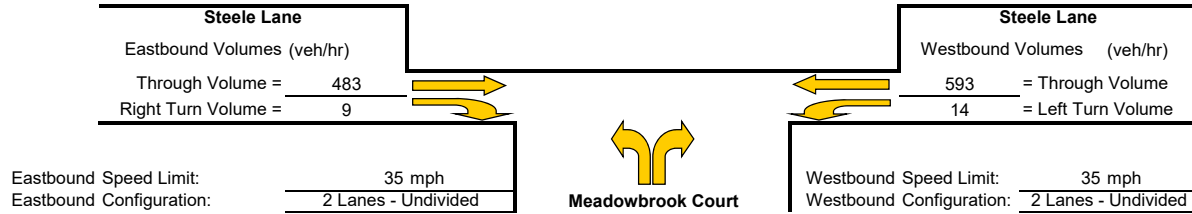

Eastbound Right Turn Lane Warrants

1. Check for right turn volume criteria

Thresholds not met, continue to next step

2. Check advance volume threshold criteria for turn lane

Advancing Volume Threshold AV = 982.6
 Advancing Volume Va = 492
 If $AV < Va$ then warrant is met No

Right Turn Lane Warranted: NO

Eastbound Right Turn Taper Warrants

(evaluate if right turn lane is unwarranted)

1. Check taper volume criteria

NOT WARRANTED - Less than 20 vehicles

2. Check advance volume threshold criteria for taper

Advancing Volume Threshold AV = -
 Advancing Volume Va = 492
 If $AV < Va$ then warrant is met -

Right Turn Taper Warranted: NO

Westbound Left Turn Lane Warrants

Percentage Left Turns %lt 2.3 %
 Advancing Volume Threshold AV 923 veh/hr
 If $AV < Va$ then warrant is met

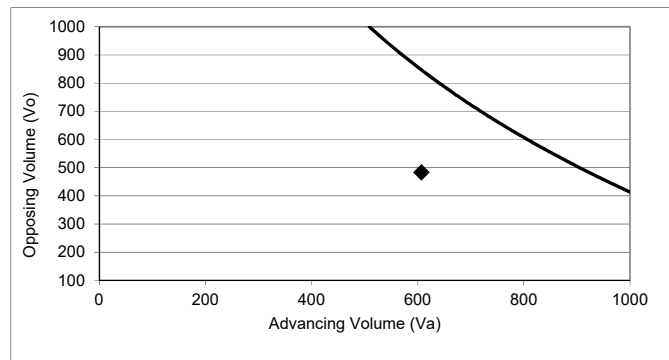

◆ Study Intersection

Two lane roadway warrant threshold for: 35 mph

Turn lane warranted if point falls to right of warrant threshold line

Left Turn Lane Warranted: NO

Methodology based on Washington State Transportation Center Research Report *Method For Prioritizing Intersection Improvements*, January 1997.

The right turn lane and taper analysis is based on work conducted by Cottrell in 1981.

The left turn lane analysis is based on work conducted by M.D. Harmelink in 1967, and modified by Kikuchi and Chakroborty in 1991.

Turn Lane Warrant Analysis - Tee Intersections

Study Intersection: Steele Lane/Meadowbrook Court

Study Scenario: PM Existing plus Project

Direction of Analysis Street: East/West

Cross Street Intersects: From the South

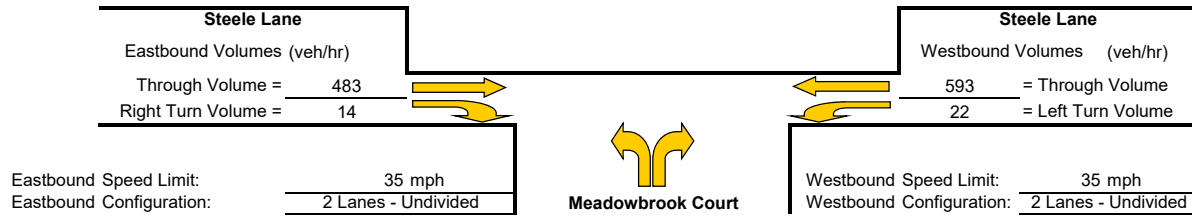

Eastbound Right Turn Lane Warrants

1. Check for right turn volume criteria

Thresholds not met, continue to next step

2. Check advance volume threshold criteria for turn lane

Advancing Volume Threshold AV = 945.1
 Advancing Volume Va = 497
 If $AV < Va$ then warrant is met No

Right Turn Lane Warranted: NO

Eastbound Right Turn Taper Warrants

(evaluate if right turn lane is unwarranted)

1. Check taper volume criteria

NOT WARRANTED - Less than 20 vehicles

2. Check advance volume threshold criteria for taper

Advancing Volume Threshold AV = -
 Advancing Volume Va = 497
 If $AV < Va$ then warrant is met -

Right Turn Taper Warranted: NO

Westbound Left Turn Lane Warrants

Percentage Left Turns %lt 3.6 %
 Advancing Volume Threshold AV 790 veh/hr
 If $AV < Va$ then warrant is met

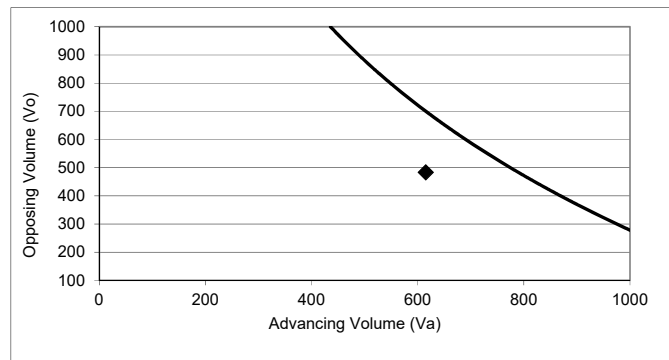

◆ Study Intersection

Two lane roadway warrant threshold for: 35 mph

Turn lane warranted if point falls to right of warrant threshold line

Left Turn Lane Warranted: NO

Methodology based on Washington State Transportation Center Research Report *Method For Prioritizing Intersection Improvements*, January 1997.

The right turn lane and taper analysis is based on work conducted by Cottrell in 1981.

The left turn lane analysis is based on work conducted by M.D. Harmelink in 1967, and modified by Kikuchi and Chakroborty in 1991.

INTERSECTION TURNING MOVEMENT COUNTS

PREPARED BY: AimTD LLC. tel: 714 253 7888 cs@aimtd.com

DATE: Tue, Feb 19, 19	LOCATION: NORTH & SOUTH: EAST & WEST:	Santa Rosa Range W Steele	PROJECT #: SC LOCATION #: 66 CONTROL: SIGNAL
---------------------------------	----------------------------------------------------	---------------------------------	-------------------------------------------------------------------------

NOTES: <div style="border: 1px solid black; padding: 5px; width: fit-content; margin: 5px 0;">PM SB queue</div>	AM PM MD OTHER OTHER	▲ N ▼ S	◀ W ▶ E	
-------------------------------------------------------------------------------------------------------------------------------	----------------------------------	------------	------------	--

Add U-Turns to Left Turns

LANES:	NORTHBOUND			SOUTHBOUND			EASTBOUND			WESTBOUND			TOTAL
	Range			Range			W Steele			W Steele			
	NL	NT	NR	SL	ST	SR	EL	ET	ER	WL	WT	WR	
	1	2	0	1	2	0	1	1	0	1	1	0	

U-TURNS				
NB	SB	EB	WB	TTL
0	0	0	0	0

	NORTHBOUND			SOUTHBOUND			EASTBOUND			WESTBOUND			TOTAL	
	NL	NT	NR	SL	ST	SR	EL	ET	ER	WL	WT	WR		
AM	7:00 AM	7	27	9	5	8	1	9	74	7	6	43	2	198
	7:15 AM	4	25	2	2	14	3	6	100	5	6	51	7	225
	7:30 AM	11	43	8	9	23	8	6	101	10	5	75	5	304
	7:45 AM	13	57	7	5	40	4	12	118	7	13	57	5	338
	8:00 AM	15	58	7	11	37	8	16	95	19	9	93	11	379
	8:15 AM	15	59	3	5	56	5	16	119	12	2	52	12	356
	8:30 AM	12	51	7	10	36	6	7	98	14	5	59	10	315
	8:45 AM	15	56	11	11	34	6	12	96	12	4	58	9	324
	VOLUMES	92	376	54	58	248	41	84	801	86	50	488	61	2,439
	APPROACH %	18%	72%	10%	17%	71%	12%	9%	82%	9%	8%	81%	10%	
APP/DEPART	522	/	521	347	/	384	971	/	913	599	/	621	0	
BEGIN PEAK HR	7:45 AM													
VOLUMES	55	225	24	31	169	23	51	430	52	29	261	38	1,388	
APPROACH %	18%	74%	8%	14%	76%	10%	10%	81%	10%	9%	80%	12%		
PEAK HR FACTOR	0.950			0.845			0.906			0.726			0.916	
APP/DEPART	304	/	314	223	/	250	533	/	485	328	/	339	0	
MIDDAY	11:30 AM	18	39	13	22	69	5	9	76	14	17	59	13	354
	11:45 AM	11	50	13	15	57	8	8	62	13	12	78	12	339
	12:00 PM	26	40	8	14	74	10	9	75	14	19	85	19	393
	12:15 PM	29	58	11	13	74	7	11	83	13	14	74	22	409
	12:30 PM	25	41	8	7	70	8	12	64	10	15	66	17	343
	12:45 PM	19	59	10	12	66	6	12	77	12	13	77	13	376
	1:00 PM	22	69	5	3	66	5	14	68	10	11	69	16	358
	1:15 PM	23	53	6	11	67	6	15	72	4	13	68	17	355
	VOLUMES	173	409	74	97	543	55	90	577	90	114	576	129	2,927
	APPROACH %	26%	62%	11%	14%	78%	8%	12%	76%	12%	14%	70%	16%	
APP/DEPART	656	/	628	695	/	747	757	/	748	819	/	804	0	
BEGIN PEAK HR	12:00 PM													
VOLUMES	99	198	37	46	284	31	44	299	49	61	302	71	1,521	
APPROACH %	30%	59%	11%	13%	79%	9%	11%	76%	13%	14%	70%	16%		
PEAK HR FACTOR	0.852			0.921			0.916			0.882			0.930	
APP/DEPART	334	/	313	361	/	394	392	/	382	434	/	432	0	
PM	4:00 PM	26	51	6	21	96	15	12	89	21	21	99	11	468
	4:15 PM	31	42	16	21	81	9	10	82	14	18	102	16	442
	4:30 PM	29	39	10	18	95	10	10	85	14	16	109	12	447
	4:45 PM	22	48	10	26	112	20	11	99	28	17	121	14	528
	5:00 PM	20	48	9	17	128	22	13	82	13	19	107	12	490
	5:15 PM	29	50	13	19	106	17	4	94	12	19	107	15	485
	5:30 PM	25	44	14	16	106	7	14	100	22	19	110	15	492
	5:45 PM	15	33	16	5	92	18	6	84	17	25	108	14	433
	VOLUMES	197	355	94	143	816	118	80	715	141	154	863	109	3,785
	APPROACH %	30%	55%	15%	13%	76%	11%	9%	76%	15%	14%	77%	10%	
APP/DEPART	646	/	544	1,077	/	1,111	936	/	952	1,126	/	1,178	0	
BEGIN PEAK HR	4:45 PM													
VOLUMES	96	190	46	78	452	66	42	375	75	74	445	56	1,995	
APPROACH %	29%	57%	14%	13%	76%	11%	9%	76%	15%	13%	77%	10%		
PEAK HR FACTOR	0.902			0.892			0.891			0.946			0.945	
APP/DEPART	332	/	288	596	/	601	492	/	499	575	/	607	0	

0	0	0	0	0
0	0	0	0	0
0	0	0	0	0
0	0	0	0	0
0	0	0	0	0
0	0	0	0	0
0	0	0	0	0
0	0	0	0	0
0	0	0	0	0
0	0	0	0	0

0	0	0	0	0
0	0	0	0	0
0	0	0	0	0
0	0	0	0	0
0	0	0	0	0
0	0	0	0	0
0	0	0	0	0
0	0	0	0	0
0	0	0	0	0
0	0	0	0	0

0	0	0	0	0
0	0	0	0	0
0	0	0	0	0
0	0	0	0	0
0	0	0	0	0
0	0	0	0	0
0	0	0	0	0
0	0	0	0	0
0	0	0	0	0
0	0	0	0	0

