

ABBREVIATIONS

&	AND
Z	ANGLE
@	AT
CL	CENTERLINE
(E)	EXISTING
(F)	FUTURE
(N)	NEW
A.B.	ANCHOR BOLT
A.C.	ASPHALT CONCRETE
ACCOUT.	ACCUPTICAL
ADA	AMERICANS WITH DISABILITIES ACT
ADJ.	ADJUSTABLE
A.F.	ACCESS FLOOR
AFF	ABOVE FINISH FLOOR
AFS	AUTOMATIC FIRE SPRINKLERS
ALUM.	ALUMINUM
ATT.	ATTENUATION
BD.	BOARD
BLDG.	BUILDING
BLK.	BLOCK
BLKTS.	BLANKETS
C	CARPET
C.F.S.	CHANNEL FRAMING SYSTEM
C.G.	CORNER GUARD
CH	CHICK
CLG.	CEILING
CLR.	CLEAR
CONF.	CONFERENCE
CONC.	CONCRETE
CONT.	CONTINUOUS
C.P.	CARPET PAD
CSK.	COUNTERSINK
C.T.	CARPET TILE
DET.	DETAIL
DM.	DIMENSION
EA	EACH
EEWS	EMERG. EYEWASH & SHOWER
EL.	ELEVATION
EMERG.	EMERGENCY
E.P.B.	ELECTRIC PANEL BOARD
E.W.C.	ELECTRICAL WATER COOLER
EXT.	EXTERIOR
F.B.	FLAT BAR
F.D.	FLOOR DRAIN
F.E.	FIRE EXTINGUISHER
F.E.C.	FIRE EXTINGUISHER CABINET
F.H.C.	FIRE HOSE CABINET
FN.	FINISH
FL.	FLOOR
F.O.C.	FACE OF CONCRETE
F.O.F.	FACE OF FINISH
F.O.M.	FACE OF MASONRY
F.O.S.	FACE OF STUD
F.R.P.	FIBERGLASS REINFORCED PLASTIC
F.S.	FIRE SPRINKLER
FTGS.	FOOTINGS
F.V.C.	FIRE VALVE CABINET
F.W.	FABRIC WALL COVERING
F.W.P.	FABRIC WRAPPED PANELS
G	GROUT
GA.	GAUGE
GALV.	GALVANIZED
G.B.	GRAB BAR
GBDW	GYPSUM BOARD DRY WALL
G.I.	GALVANIZED IRON
GL.	GLASS
GR.	GRADE
H.C.	HANDICAPPED
H.M.	HOLLOW METAL
H.P.	HIGH POINT
INCL.	INCLUDING
INS.	INSIDE
INSUL.	INSULATION
LAM.	LAMINATE
LAV.	LAVATORY
L.P.	LOW POINT or PLASTIC LAMINATE
L.S.D.	LIQUID SOAP DISPENSER
MAX.	MAXIMUM
M.B.	MACHINE BOLT
M.F.	MONOLITHIC FLOORING
MFR.	MANUFACTURER
MIN.	MINIMUM
MTL.	METAL
N.I.C.	NOT IN CONTRACT
N.T.S.	NOT TO SCALE
O.C.	ON CENTER
O.D.	OVERFLOW DRAIN
OPNG.	OPENING
P	PLATE
P	PANT
PLAS.	PLASTER
PLWD.	PLYWOOD
P.T.	POINT
P.T.D.	PAPER TOWEL DISPENSER
R.	RISER
R.B.	RESILIENT BASE
R.D.	ROOF DRAIN
REF.	REFRIGERATOR
REQD.	REQUIRED
R.F.	RESILIENT FLOORING
RM.	ROOM
RSB	RECESSED SOAP DISPENSER
R.T.	RESILIENT TILE
R.W.D.	REDWOOD
R.W.L.	RAIN WATER LEADER
S.A.D.	SEE ARCHITECTURAL DRAWINGS
S.C.	SEBULE CONCRETE
S.D.	STORM DRAIN
S.F.	STONE FLOORING
S.G.	SPECIAL GLASS
SHT.	SHEET
SM	SIMILAR
S.M.	SOLID SURFACING MATERIAL
S.N.D.	SANITARY NAPKIN DISPENSER
S.N.R.	SANITARY NAPKIN RECEPTACLE
S.S.	STAINLESS STEEL
S.S.D.	SEE STRUCTURAL DRAWINGS
STL.	STEEL
STRUCT.	STRUCTURAL
T.	TREAD
T.C.V.	TEMP. CONTROL VALVE
T&B	TOP AND BOTTOM
T.O.S.	TOP OF SLAB
T.S.	TUBE SECTION
TYP.	TYPICAL
T.P.	TOILET PAPER
T.S.C.	TOILET SEAT COVER
U.G.	UNDERGROUND
U.O.N.	UNLESS OTHERWISE NOTED
UR.	URINAL
VCT.	VINYL COMPOSITION TILE
V.V.	VINYL WALL COVERING
W	WITH
W.B.	WOOD BASE
W.F.	WOOD FLOORING
W.H.	WATER HEATER
W.P.	WATERPROOF
W.R.	WATER RESISTANCE
W.T.	WINDOW TREATMENT
W.V.	WOOD VENEER
W.W.F.	WELDED WIRE FABRIC



JANE DISPENSARY TENANT IMPROVEMENT 4040 SONOMA HIGHWAY SANTA ROSA, CA 95249 A.P.N. 032-500-040

GENERAL NOTES

- ALL WORK PERFORMED SHALL COMPLY WITH THE REQUIREMENTS OF THE 2019 CALIFORNIA BUILDING CODE, AND OTHER LOCAL, STATE OR FEDERAL CODES AND ORDINANCES AS THEY APPLY TO THE WORK PERFORMED HERE-IN.
- THE CONTRACTOR AND/OR SUBCONTRACTORS SHALL VISIT THE JOB SITE AND VERIFY DRAWINGS AND CONDITIONS AND BRING TO THE DESIGNER'S ATTENTION ANY DISCREPANCIES, ERRORS, OR OMISSIONS REQUIRING CLARIFICATION OR REVISION BEFORE COMMENCING WITH THE WORK.
- THE DRAWINGS SHALL NOT BE SCALED. THE DRAWINGS SHALL BE CONSIDERED A GUIDE AND EXISTING PARTITIONS SHALL TAKE PRECEDENCE OVER SCALE OR DIMENSIONS. ALL DIMENSIONS SHOWN ARE TO FACE OF STUD OR CONCRETE. CONTRACTOR SHALL NOTIFY THE DESIGNER IF UNKNOWN WIRES, PLUMBING VENTS OR FRAMING PROBLEMS ARISE BEFORE TRYING TO RECTIFY SAME.
- JOB SITE CONDITIONS DURING THE COURSE OF CONSTRUCTION, INCLUDING THE SAFETY OF ALL PERSONS AND DAMAGE TO THE PROPERTY, SHALL BE THE SOLE RESPONSIBILITY OF THE CONTRACTOR.
- TEMPORARY SHORING SHALL BE THE SOLE RESPONSIBILITY OF THE CONTRACTOR.
- THE CONTRACTOR WILL HOLD HARMLESS, INDEMNIFY AND DEFEND THE OWNER, THE DESIGNER AND HIS CONSULTANTS AND EACH OF THEIR OFFICERS AND EMPLOYEES AND AGENTS FROM ANY AND ALL LIABILITY CLAIMS, LOSSES AND DAMAGES ARISING OR ALLEGED TO ARISE FROM THE PERFORMANCE OF THE WORK DESCRIBED HERE-IN, BUT NOT INCLUDING THE SOLE NEGLIGENCE OF THE OWNER, THE DESIGNER AND HIS CONSULTANTS, AND EACH OF THEIR OFFICERS, EMPLOYEES AND AGENTS.
- CONTRACTOR SHALL AT ALL TIMES KEEP THE PREMISES NEAT AND ORDERLY, IN A SAFE WORKING CONDITION, AND FREE FROM ACCUMULATION OF WASTE MATERIALS CAUSED BY HIS OPERATION. AT THE COMPLETION OF THE WORK, HE SHALL REMOVE ALL WASTE MATERIAL, TOOLS, CONSTRUCTION EQUIPMENT, MACHINERY, AND SURPLUS MATERIALS FROM THE PREMISES, SHALL CLEAN ALL GLASS SURFACES, AND LEAVE THE WORK BROOM CLEAN THROUGHOUT. IF THE CONTRACTOR FAILS TO CLEANUP, THE OWNER MAY DO SO AND THE COST THEREOF SHALL BE PAID BY THE CONTRACTOR.
- DUE TO THE NATURE OF PROJECTS INVOLVING EXISTING CONDITIONS, WE RESERVE THE RIGHT TO MODIFY OUR REQUIREMENTS DURING CONSTRUCTION DUE TO FIELD CONDITIONS. THE COSTS FOR MODIFICATION REQUIRED BY OUR OFFICE SHALL BE SOLELY THE RESPONSIBILITY OF THE OWNER AND WE ASSUME NO LIABILITY FOR THESE CONDITIONS OTHER THAN TO PROPERLY ADJUST OUR DETAILS, DESIGNS, AND CALCULATIONS IF WE FEEL THIS TO BE NECESSARY.
- THE DESIGNER SHALL NOT BE RESPONSIBLE FOR ANY UNAUTHORIZED CHANGES TO OR USE OF THESE DRAWINGS. ALL CHANGES TO THE DRAWINGS MUST BE IN WRITING AND APPROVED BY THE DESIGNER.

SCOPE OF WORK

THE SCOPE OF WORK SHALL CONSIST OF THE FOLLOWING:
TENANT IMPROVEMENT TO AN EXISTING RETAIL SPACE (1/3RD OF (E) 1-STORY BUILDING) FOR THE PURPOSES OF RETAIL CANNABIS SALES. AT REAR: EXISTING ACCESSIBLE BATHROOM TO REMAIN, REMODEL BREAK-ROOM, AND INVENTORY OFFICE WITH STORAGE. THE WORK WILL NOT INVOLVE STRUCTURAL MODIFICATIONS.

CONTACTS

OWNER: 2074 ARMORY INC.
1030 2nd ST, SUITE 2A
SANTA ROSA, CA 95404
707-529-8385

ARCHITECT: BEVING ARCHITECTURE INC.
MICA BEVING
PO BOX 154
VENTURA, CA 93002
805-302-9166

MECHANICAL ENGINEER: 15000 INC.
2901 CLEVELAND AVE., SUITE 204
SANTA ROSA, CA 95403
707-577-0363

LIGHTING WATTAGE CALCS: DELTA T ENERGY
adrian@deltatenergyconsulting.com
707-827-0233

CONSTRUCTION TYPE: III-B
OCCUPANCY: M

OCCUPANT LOAD: S.F./FACTOR TABLE 10-A LOAD
MERCANTILE / OFFICE 2012 / 100 = 20

CODE REFERENCE

THE DESIGN AND CONSTRUCTION OF ALL SITE ALTERATIONS SHALL COMPLY WITH THE 2019:

- CALIFORNIA BUILDING CODE (CBC)
- CALIFORNIA ELECTRICAL CODE (CEC)
- CALIFORNIA MECHANICAL CODE (CMC)
- CALIFORNIA PLUMBING CODE (CPC)
- CALIFORNIA ENERGY CODE
- CALIFORNIA FIRE CODE (CFC)
- CALIFORNIA EXISTING BUILDING CODE (CEBC)
- CALIFORNIA GREEN BUILDING CODE (CALGREEN)
- CALIFORNIA RESIDENTIAL CODE (CRC)
- CALIFORNIA HEALTH AND SAFETY CODE (H&SC)
- CALIFORNIA BUSINESS AND PROFESSIONS CODE (B&PC)
- NATIONAL FIRE PROTECTION ASSOCIATION STANDARDS (NFPA)
- MEDICAL AND ADULT USE CANNABIS REGULATION AND SAFETY ACT (MAUCRSA)
- SANTA ROSA CITY CODE (SRCC)

SHEET INDEX

SHEET	DESCRIPTION
T.001	COVER SHEET, GENERAL NOTES, VICINITY MAP AND INDEX

ARCHITECTURAL:

A.201	AS-BUILT / DEMO. FLOOR PLAN
A.211	PROPOSED FLOOR PLAN
A.301	EXTERIOR ELEVATIONS & BUILDING SECTIONS
A.500	ADA ACCESSIBILITY DETAILS
A.501	INTERIOR ELEVATIONS
A.502	INTERIOR ELEVATIONS

STAMPS / APPROVALS

City of Santa Rosa
Planning & Economic
Development Department
Aug 12, 2021
RECEIVED

LUNA DESIGN

PO Box 1973,
Sonoma CA 95476
Office 707.935.8546
Cell 415.806.6084
www.lunadesignsonoma.com

Steven G. Moody

THESE DRAWINGS ARE THE PROPERTY OF LUNA DESIGN. ALL DESIGNS AND OTHER INFORMATION CONTAINED ON THESE DRAWINGS ARE FOR USE ON THE SPECIFIC PROJECT AND SHALL NOT BE USED ON OTHER PROJECTS, OR FOR ADDITIONS TO THIS PROJECT, OR FOR COMPLETION OF THIS PROJECT BY OTHERS WITHOUT FIRST OBTAINING THE EXPRESSED WRITTEN CONSENT OF LUNA DESIGN. THESE DRAWINGS SHALL NOT BE REPRODUCED, CHANGED OR COPIED IN ANY FORM WHATSOEVER WITHOUT FIRST OBTAINING THE EXPRESSED WRITTEN PERMISSION AND CONSENT OF LUNA DESIGN, NOR ARE THEY TO BE ASSIGNED TO ANY OTHER PARTY WITHOUT SAID WRITTEN PERMISSION AND CONSENT.

JANE DISPENSARY T.I.
4040 HIGHWAY 12, SANTA ROSA CA 95249
APN: 032-500-040

Revisions:

Rev	Description	Date

Drawn By: SM
Date: 5/12/21
Scale: AS SHOWN

TITLE SHEET
T.001

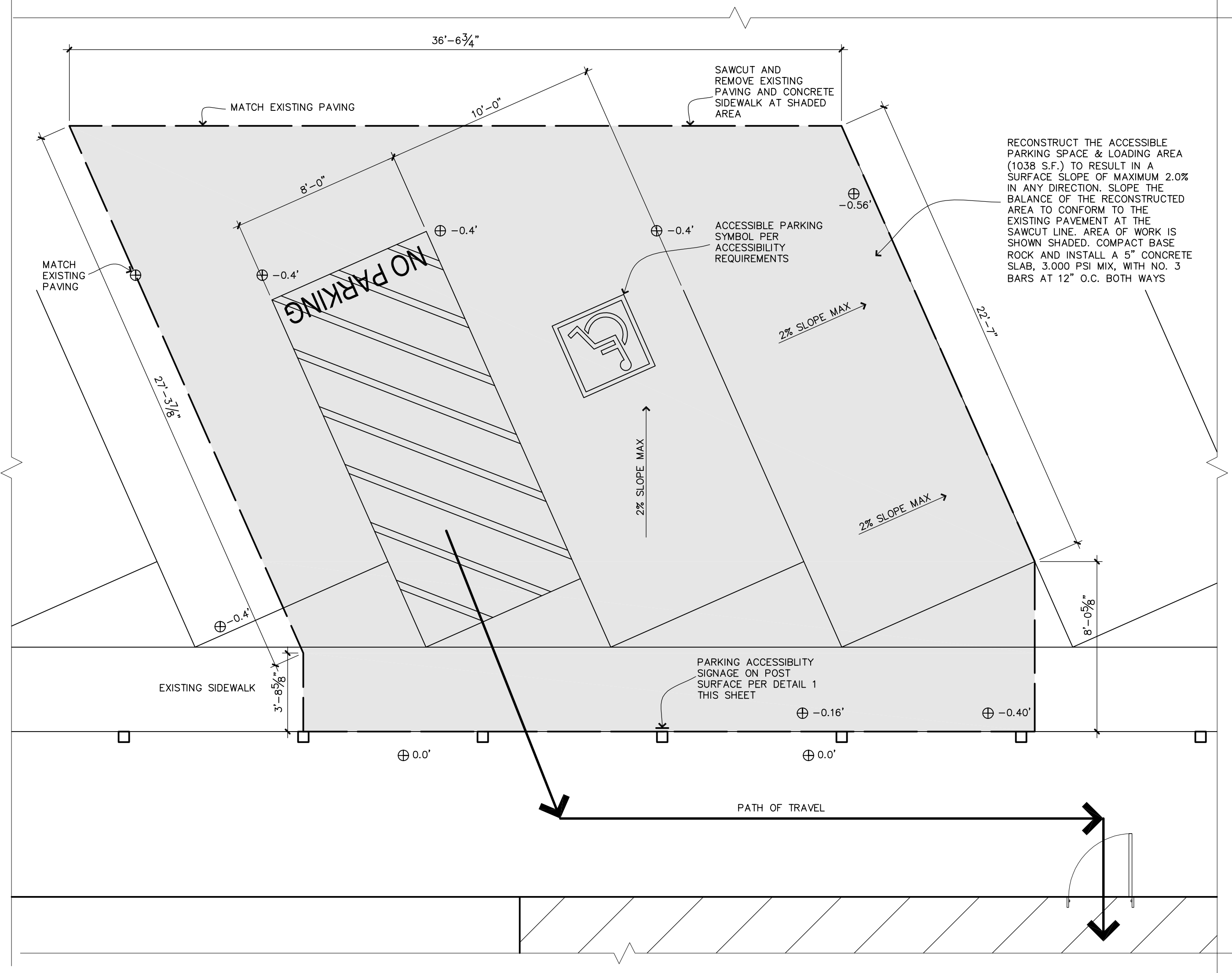

1 PARTIAL SITE PLAN
SCALE: 1/4" = 1'-0"

SUMMARIZED BUILDING CODE ANALYSIS

LOCATION: 4046 SONOMA HIGHWAY, SANTA ROSA, CALIFORNIA
 APPLICABLE CODE: 2019 CALIFORNIA BUILDING CODE (CBC),
 TITLE 24, PART 2, VOLUMES 1 AND 2

	ACTUAL	ALLOWED
1. OCCUPANCY & USE	A-3 RESTAURANT	
2. TYPE OF CONSTRUCTION	V-N	
3. NUMBER OF STORIES:	1	
4. ACTUAL BUILDING HEIGHT:	14'-0"	40'-0"
5. BUILDING AREA:	1,745 SQ. FT.	
6. AREA OF PROJECT:	21,647 SQ. FT.	
7. ALLOWABLE AREA:	N/A	
8. AREA INCREASES:	NONE	
9. HEIGHT INCREASES:	NONE	75 FEET ALLOWED
10. FIRE SPRINKLERS:	NO	
11. FIRE ALARM SYSTEM:	YES	
12. OTHER FIRE PROTECTION	YES	FIRE EXTINGUISHERS
13. SMOKE CONTROL SYSTEM:	NO	
14. BUILDING OCCUPANT LOAD		
15. YEAR OF ORIG. CONSTRUCTION:		
16. HIGH FIRE HAZARD SEVERITY ZONE:	NO	
17. EMERGENCY RESPONDER RADIO COVERAGE	YES	

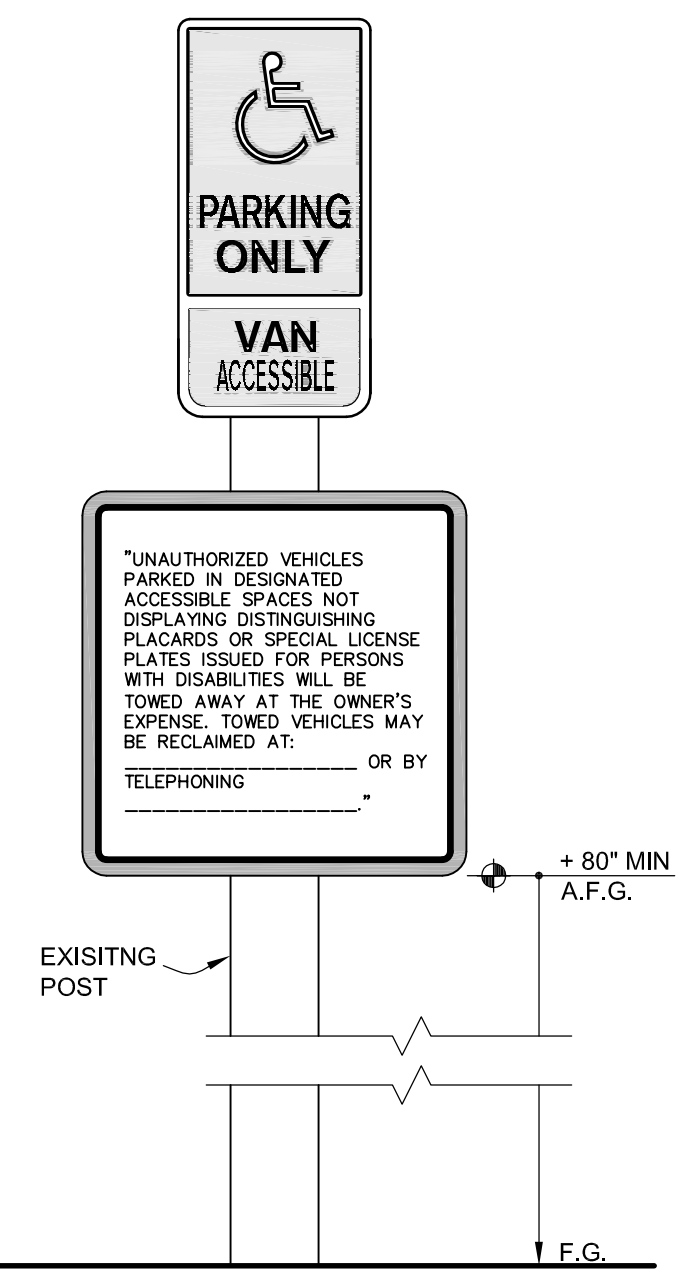

1 PARKING SIGNAGE
SCALE: NONE

APPLICABLE CODES

ALL WORK SHALL COMPLY WITH THE:
 CALIFORNIA BUILDING CODE, 2019 EDITION
 CALIFORNIA PLUMBING CODE, 2019 EDITION
 CALIFORNIA MECHANICAL CODE, 2019 EDITION
 CALIFORNIA ELECTRICAL CODE, 2019 EDITION
 CALIFORNIA ENERGY STANDARDS, 2019 EDITION
 CALGREEN CHECKLIST, 2019 EDITION
 APPLICABLE LOCAL CODES AND ORDINANCES

SHEET INDEX

- A - 1 SITE PLAN PROJECT INFORMATION
- A - 2 FLOOR PLAN & ELECTRICAL PLAN
- FS-T1 FOOD SERVICE NOTES
- FS-1 FOOD SERVICE EQUIPMENT FLOOR PLAN
- FS-2 FOOD SERVICE EQUIPMENT SCHEDULE
- FS-3 FOOD SERVICE EQUIPMENT PLUMBING PLAN
- FS-4 FOOD SERVICE EQUIPMENT ELECTRICAL PLAN

City of Santa Rosa
 Planning & Economic
 Development Department
 Aug 12, 2021
 RECEIVED

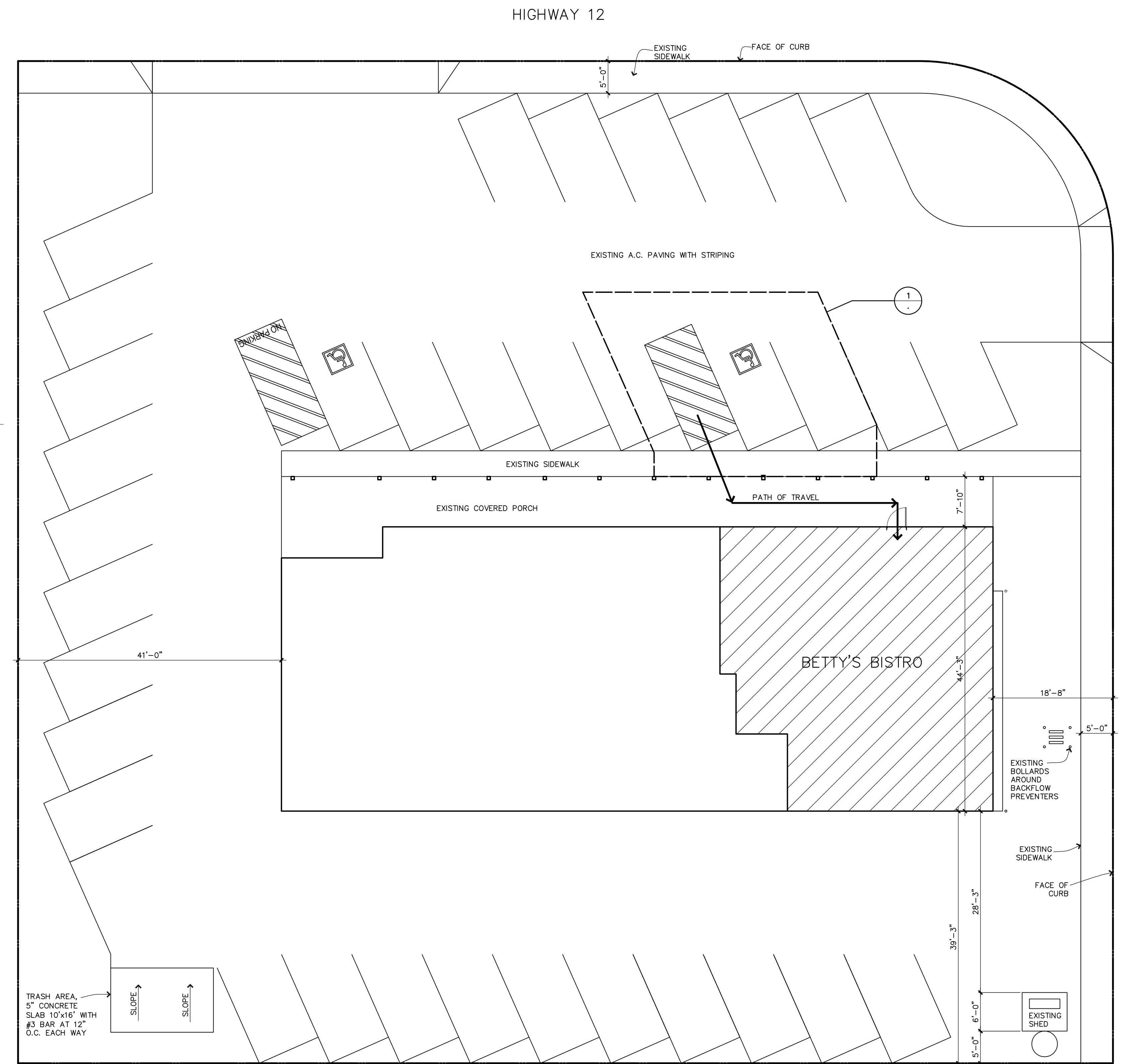

SITE PLAN
SCALE: 1" = 10'-0"

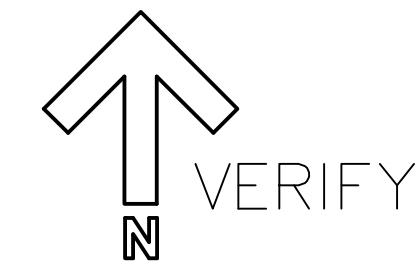

ROBERT E
 ANDERSON
 ARCHITECT

103 MORRIS STREET
 SUITE N
 SEBASTOPOL
 CALIF 95472
 707 823 7802



TENANT IMPROVEMENTS FOR:
BETTY'S BISTRO
 4046 SONOMA HIGHWAY
 SANTA ROSA, CA

DATE: 3-25-21
 Drawn: JFD

SITE PLAN

Steven A. Moody

THESE DRAWINGS ARE THE INSTRUMENTS OF SERVICE AND ARE THE PROPERTY OF LUNA DESIGN. ALL DESIGNS AND OTHER INFORMATION CONTAINED ON THESE DRAWINGS ARE FOR USE ON THE SPECIFIC PROJECT AND SHALL NOT BE USED ON OTHER PROJECTS, OR FOR ADDITIONS TO THIS PROJECT, OR FOR COMPLETION OF THIS PROJECT BY OTHERS WITHOUT FIRST OBTAINING THE EXPRESS WRITTEN CONSENT OF LUNA DESIGN. THESE DRAWINGS SHALL NOT BE REPRODUCED, CHANGED OR COPIED IN ANY FORM WHATSOEVER WITHOUT FIRST OBTAINING THE EXPRESS WRITTEN PERMISSION AND CONSENT OF LUNA DESIGN, NOR ARE THEY TO BE ASSIGNED TO ANY THIRD PARTY WITHOUT SAID WRITTEN PERMISSION AND CONSENT.

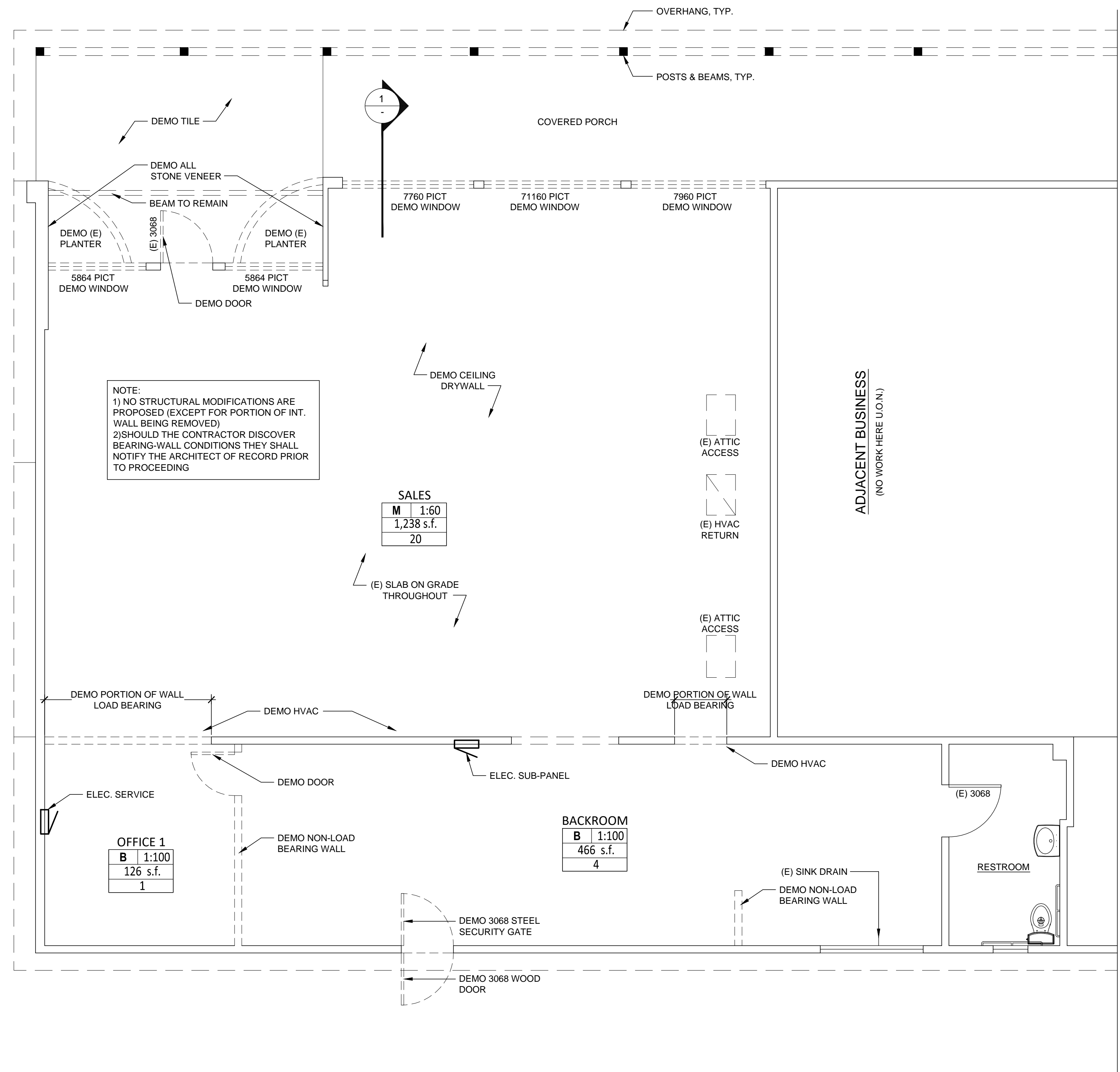

AS-BUILT / DEMO. FLOOR PLAN

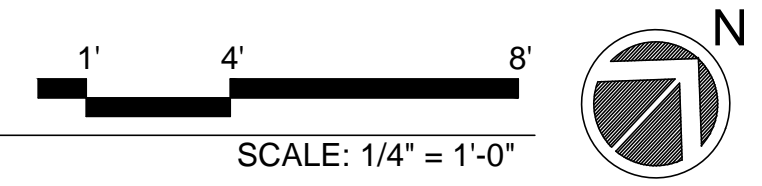

JANE DISPENSARY T.I.
4040 HIGHWAY 12, SANTA ROSA CA 95249
APN: 032-500-040

Revisions:

Rev	Description	Date

Drawn By: SM
Date: 5/12/21
Scale: AS SHOWN

AS-BUILT PLAN
A.201

Steven A. Moody

THESE DRAWINGS ARE THE INSTRUMENTS OF SERVICE AND ARE THE PROPERTY OF LUNA DESIGN. ALL DESIGNS AND OTHER INFORMATION CONTAINED ON THESE DRAWINGS ARE FOR USE ON THE SPECIFIC PROJECT AND SHALL NOT BE USED ON OTHER PROJECTS, OR FOR ADDITIONS TO THIS PROJECT, OR FOR COMPLETION OF THIS PROJECT BY OTHERS WITHOUT FIRST OBTAINING THE EXPRESSED WRITTEN CONSENT OF LUNA DESIGN. THESE DRAWINGS SHALL NOT BE REPRODUCED, CHANGED OR COPIED IN ANY FORM WHATSOEVER WITHOUT FIRST OBTAINING THE EXPRESSED WRITTEN PERMISSION AND CONSENT OF LUNA DESIGN, NOR ARE THEY TO BE ASSIGNED TO ANY THIRD PARTY WITHOUT SAID WRITTEN PERMISSION AND CONSENT.

JANE DISPENSARY T.I.
4040 HIGHWAY 12, SANTA ROSA CA 95249
APN: 032-500-040

Revisions:	Rev	Description	Date

Drawn By: SM
Date: 5/12/21
Scale: AS SHOWN

PROPOSED FLOOR PLAN
A.211

EGRESS LEGEND

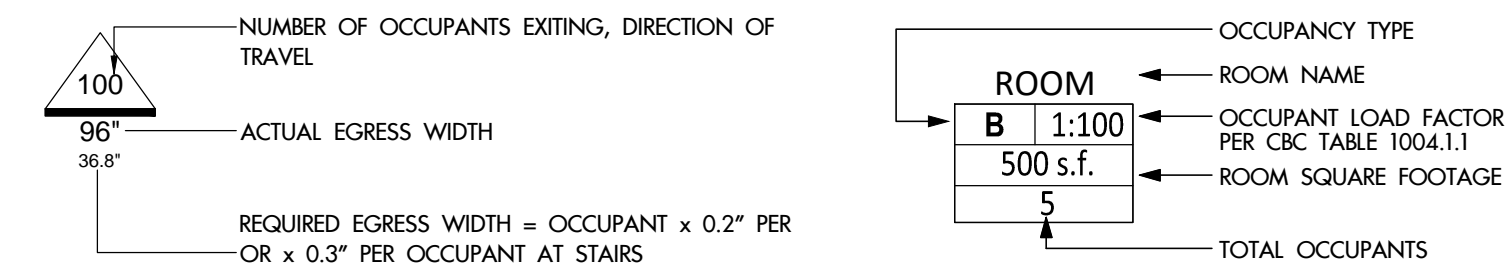

WALL TYPES

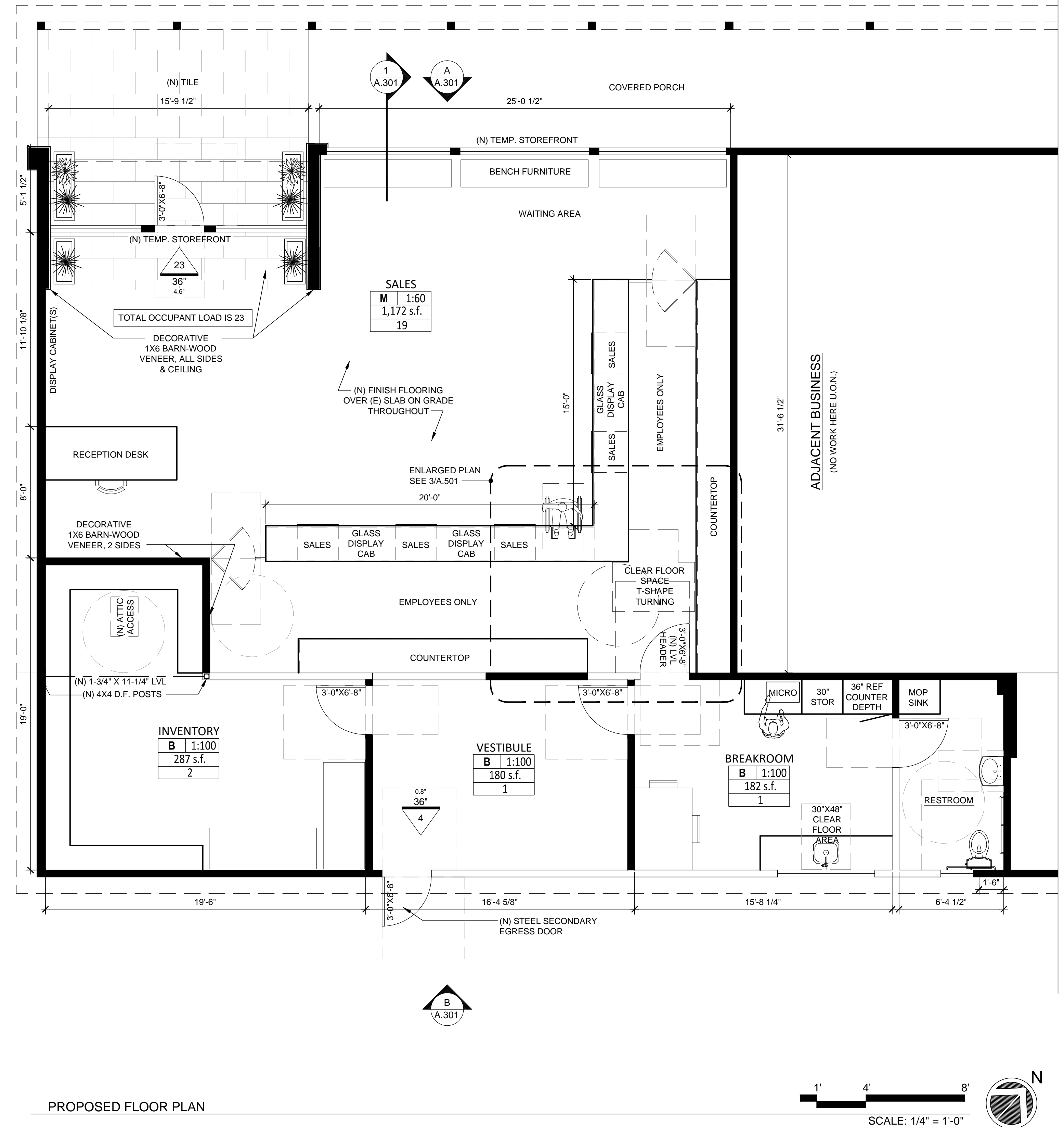
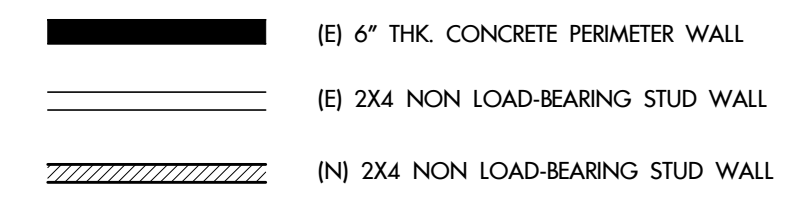

PROPOSED FLOOR PLAN

Steven A. Moody

THESE DRAWINGS ARE THE INSTRUMENTS OF SERVICE AND ARE THE PROPERTY OF LUNA DESIGN. ALL DESIGNS AND OTHER INFORMATION CONTAINED ON THESE DRAWINGS ARE FOR USE ON THE SPECIFIC PROJECT AND SHALL NOT BE USED ON OTHER PROJECTS, OR FOR ADDITIONS TO THIS PROJECT, OR FOR COMPLETION OF THIS PROJECT BY OTHERS WITHOUT FIRST OBTAINING THE EXPRESSED WRITTEN CONSENT OF LUNA DESIGN. THESE DRAWINGS SHALL NOT BE REPRODUCED, CHANGED, OR COPIED IN ANY FORM WHATSOEVER WITHOUT FIRST OBTAINING THE EXPRESSED WRITTEN PERMISSION AND CONSENT OF LUNA DESIGN, NOR ARE THEY TO BE ASSIGNED TO ANY THIRD PARTY WITHOUT SAID WRITTEN PERMISSION AND CONSENT.

JANE DISPENSARY T.I.
4040 HIGHWAY 12, SANTA ROSA CA 95249
APN: 032-500-040

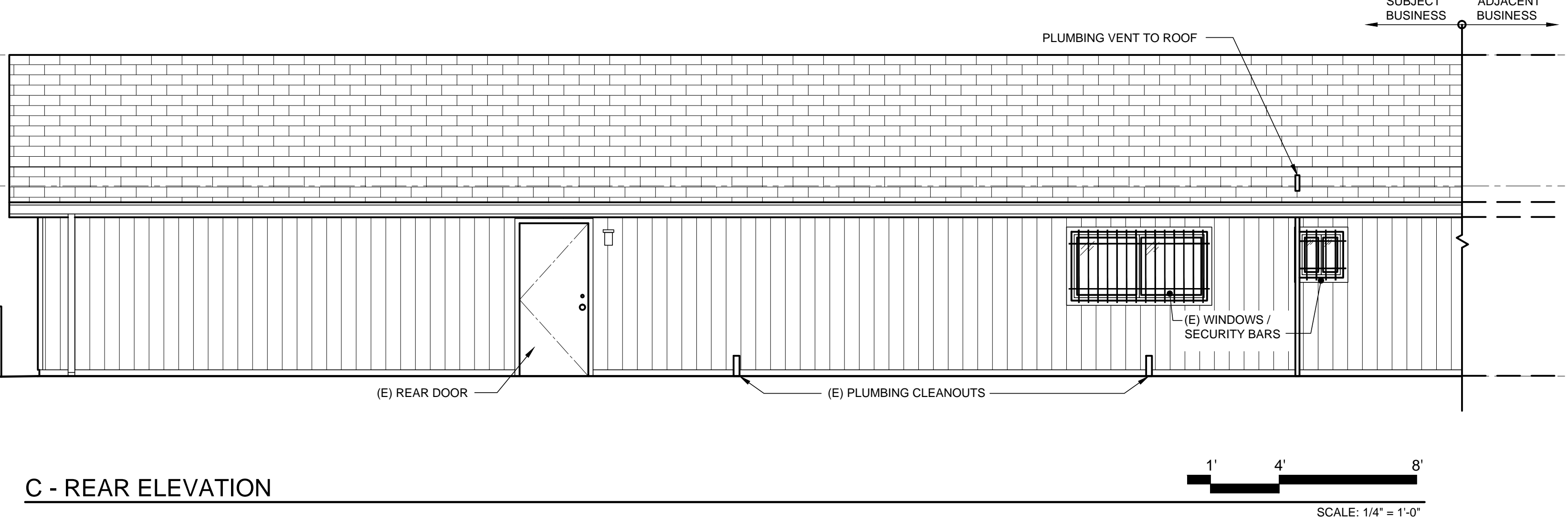
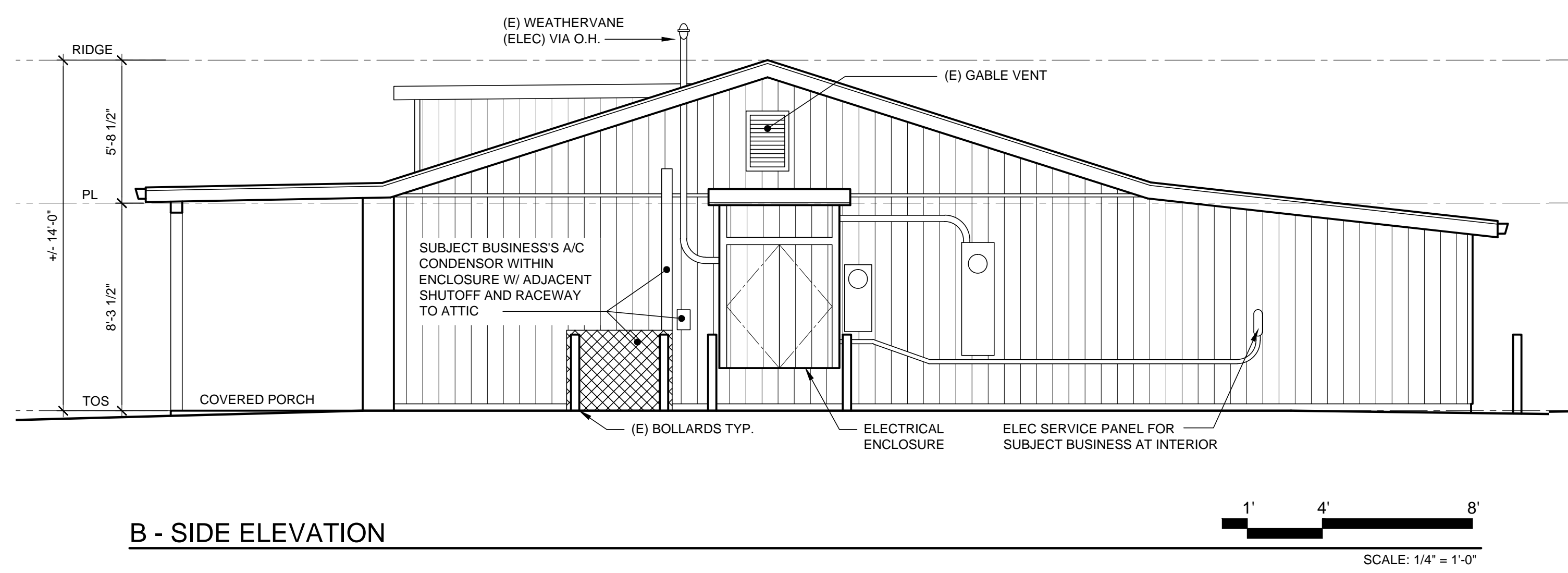
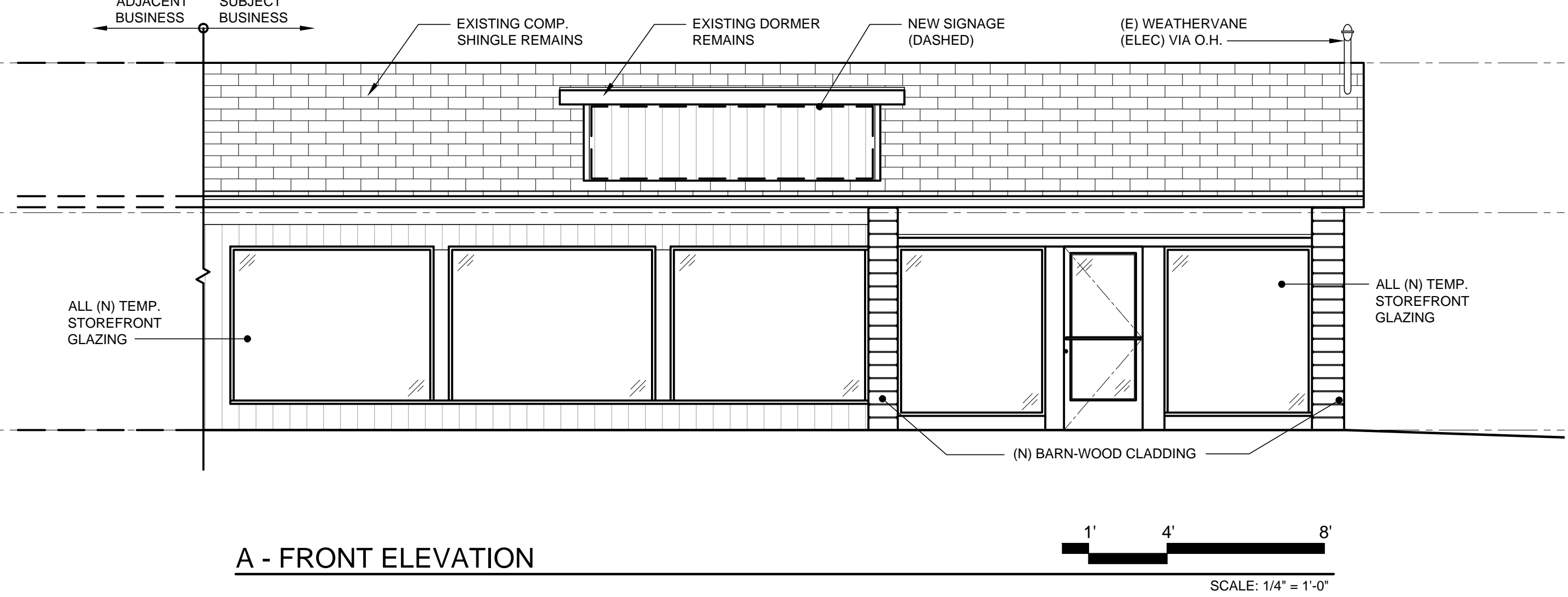
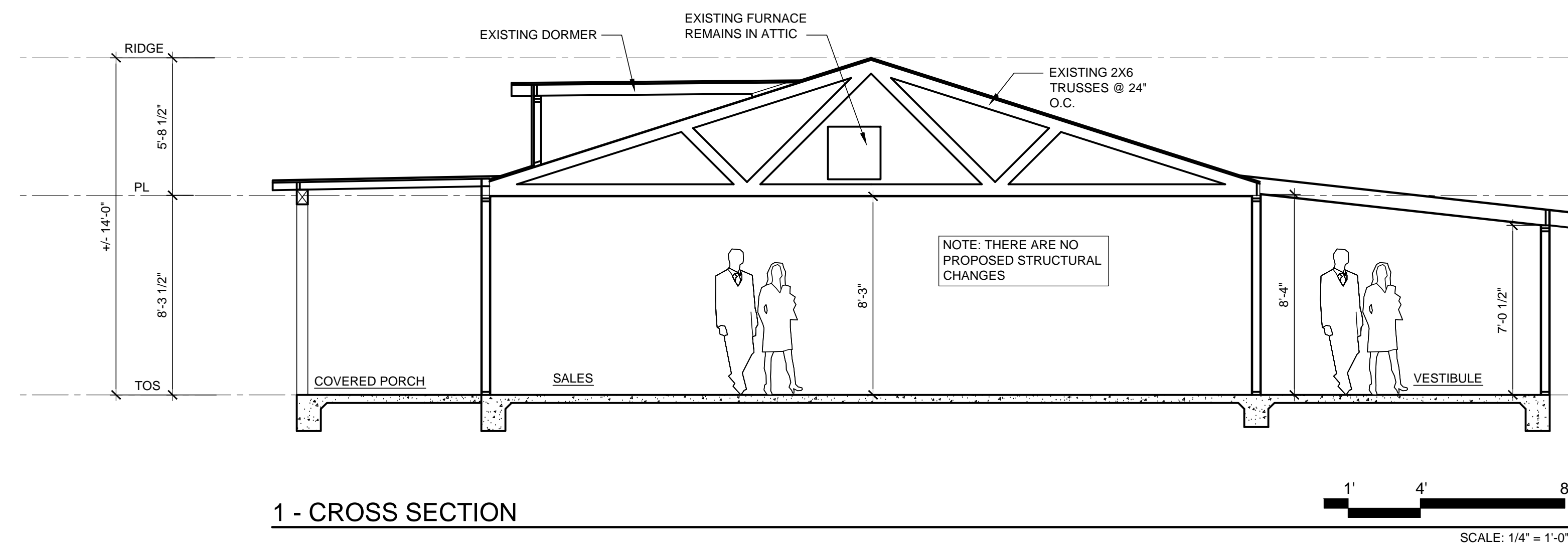

Revisions:	Rev	Description	Date

Drawn By: SM
Date: 5/12/21
Scale: AS SHOWN

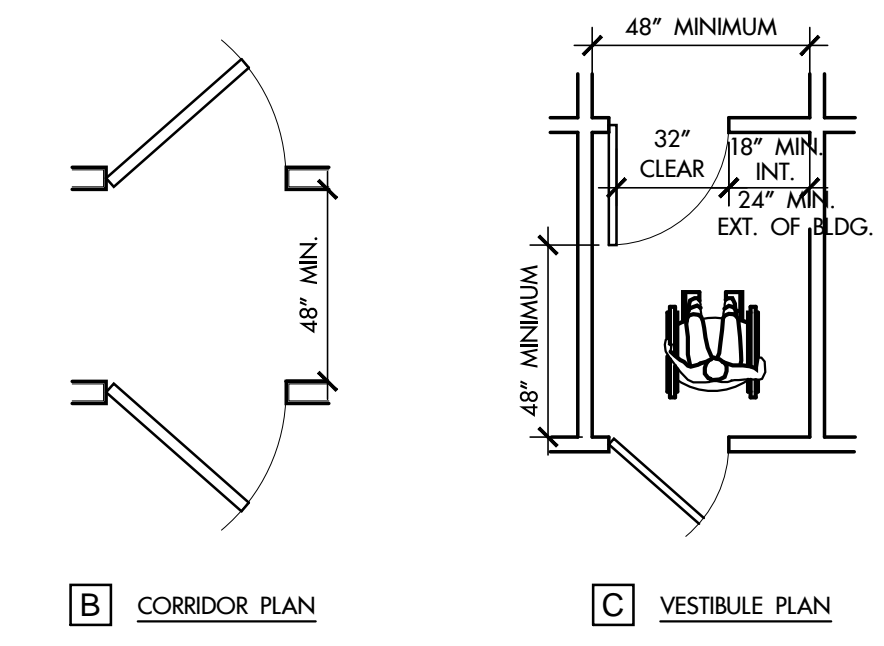
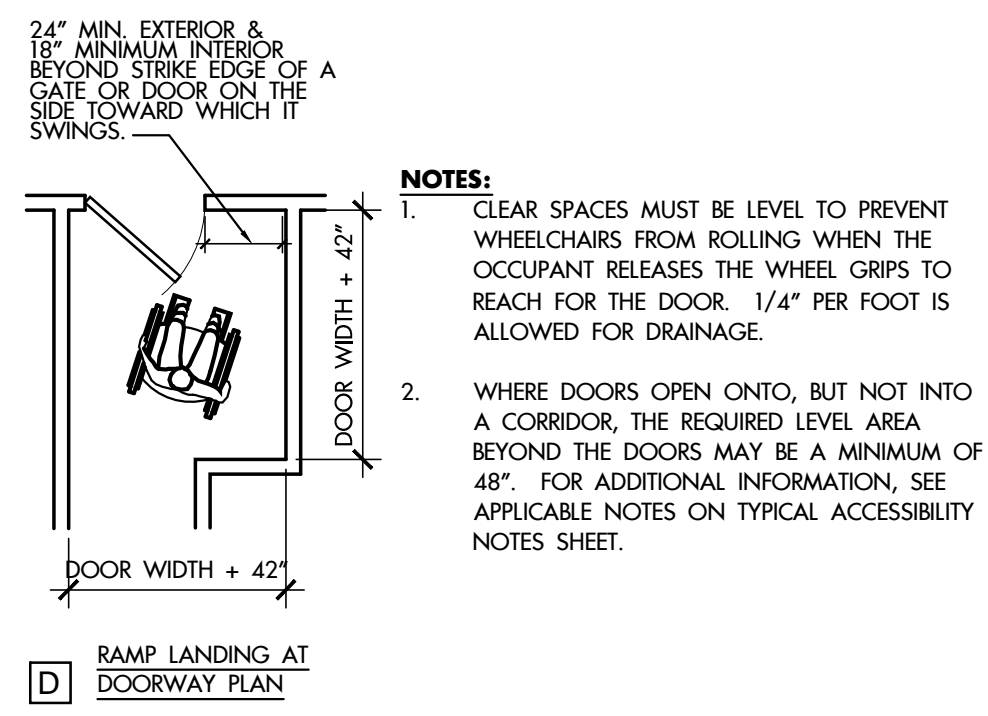

4 DOOR CLEAR SPACE

SCALE: 1/2" = 1'-0" ADA-doors clear

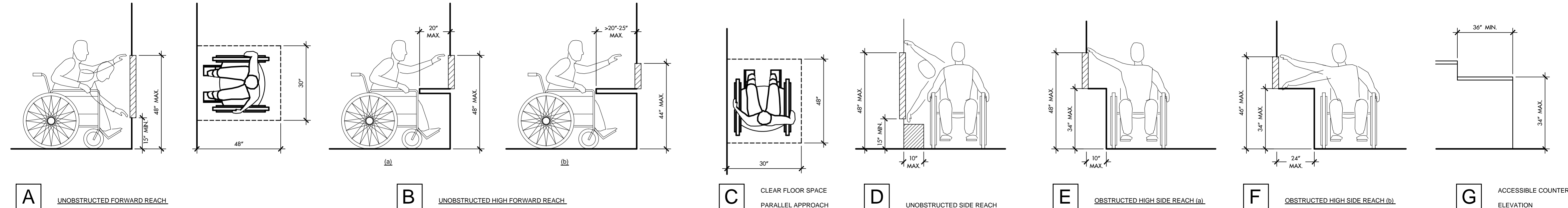

3 REACH REQUIREMENTS

SCALE: 1/2" = 1'-0" CAB-counter-01

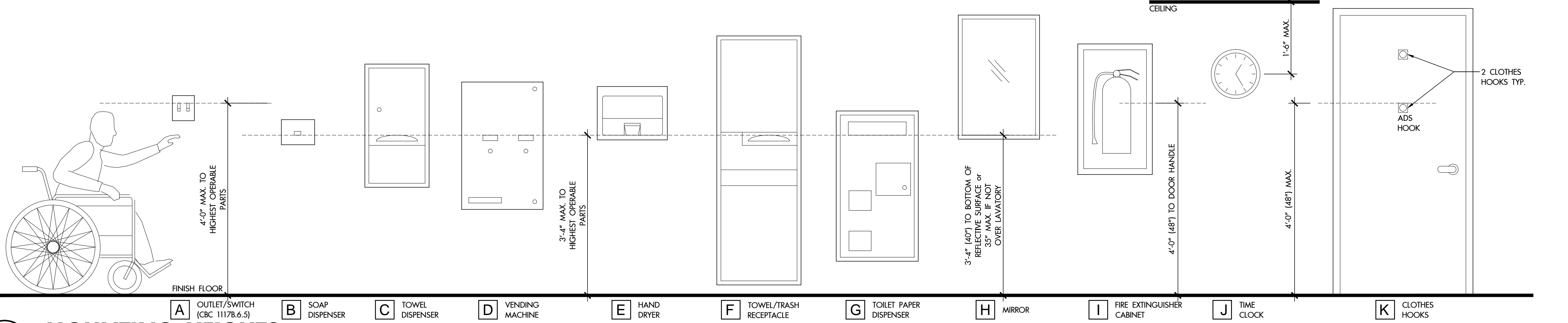

2 MOUNTING HEIGHTS

SCALE: 3/4" = 1'-0" ADA-mount hts

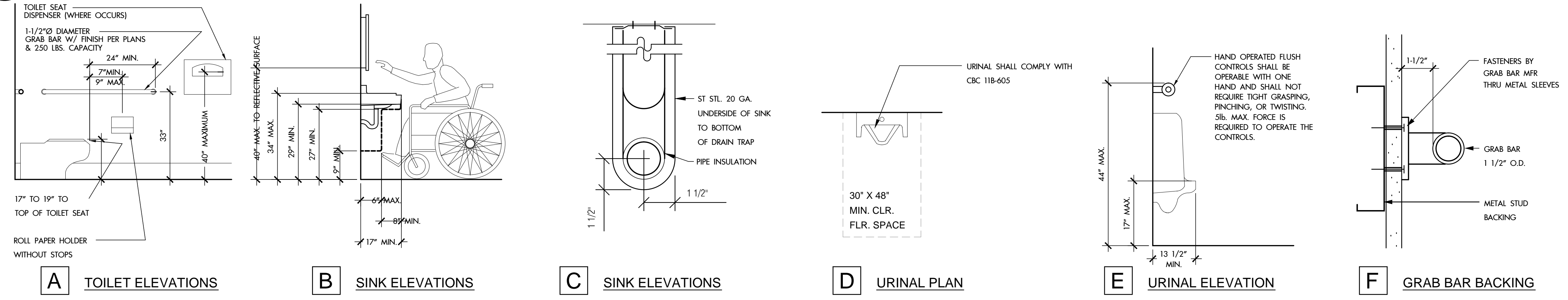
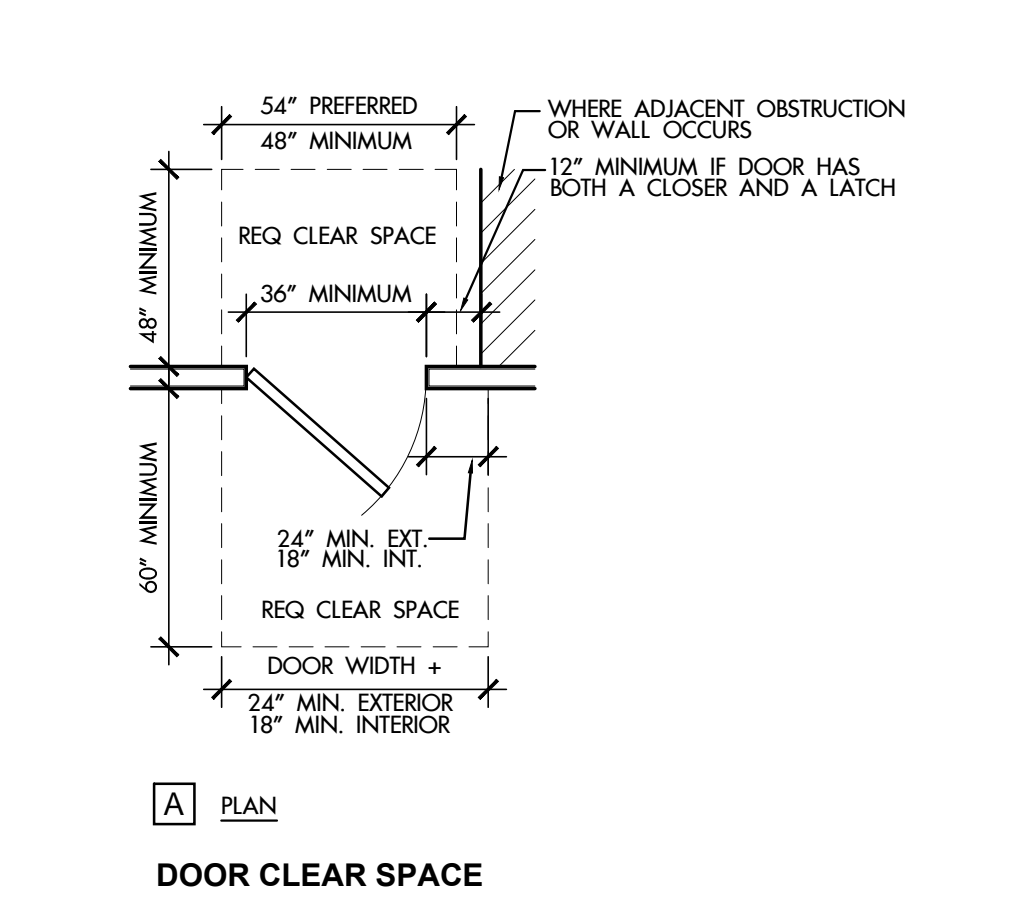

1 PLUMBING FIXTURE CLEARANCES

SCALE: 1/2" = 1'-0" ADA-fixt clr

6 ADA SIGNAGE

SCALE: 1/2" = 1'-0" ADA-signage

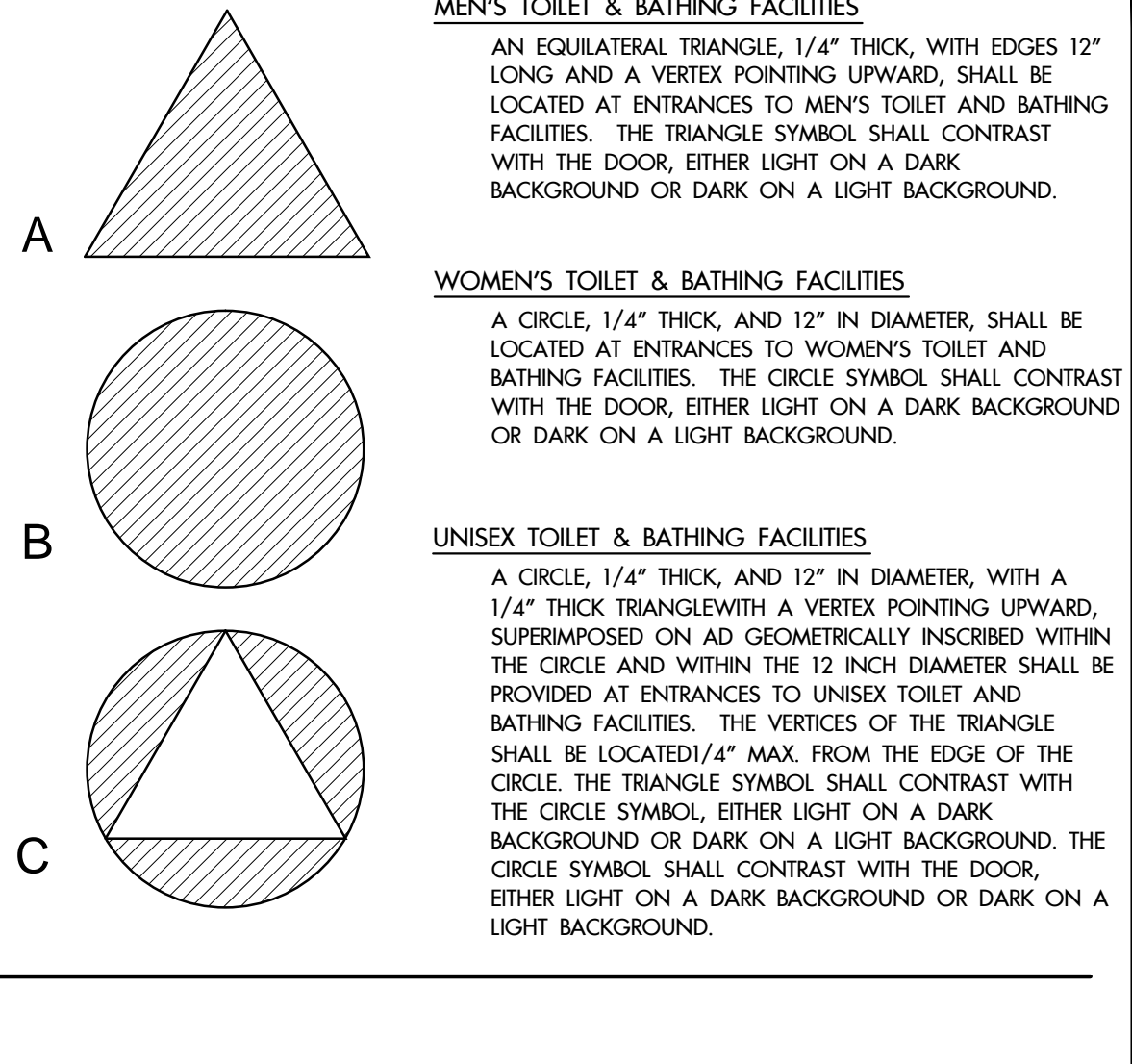
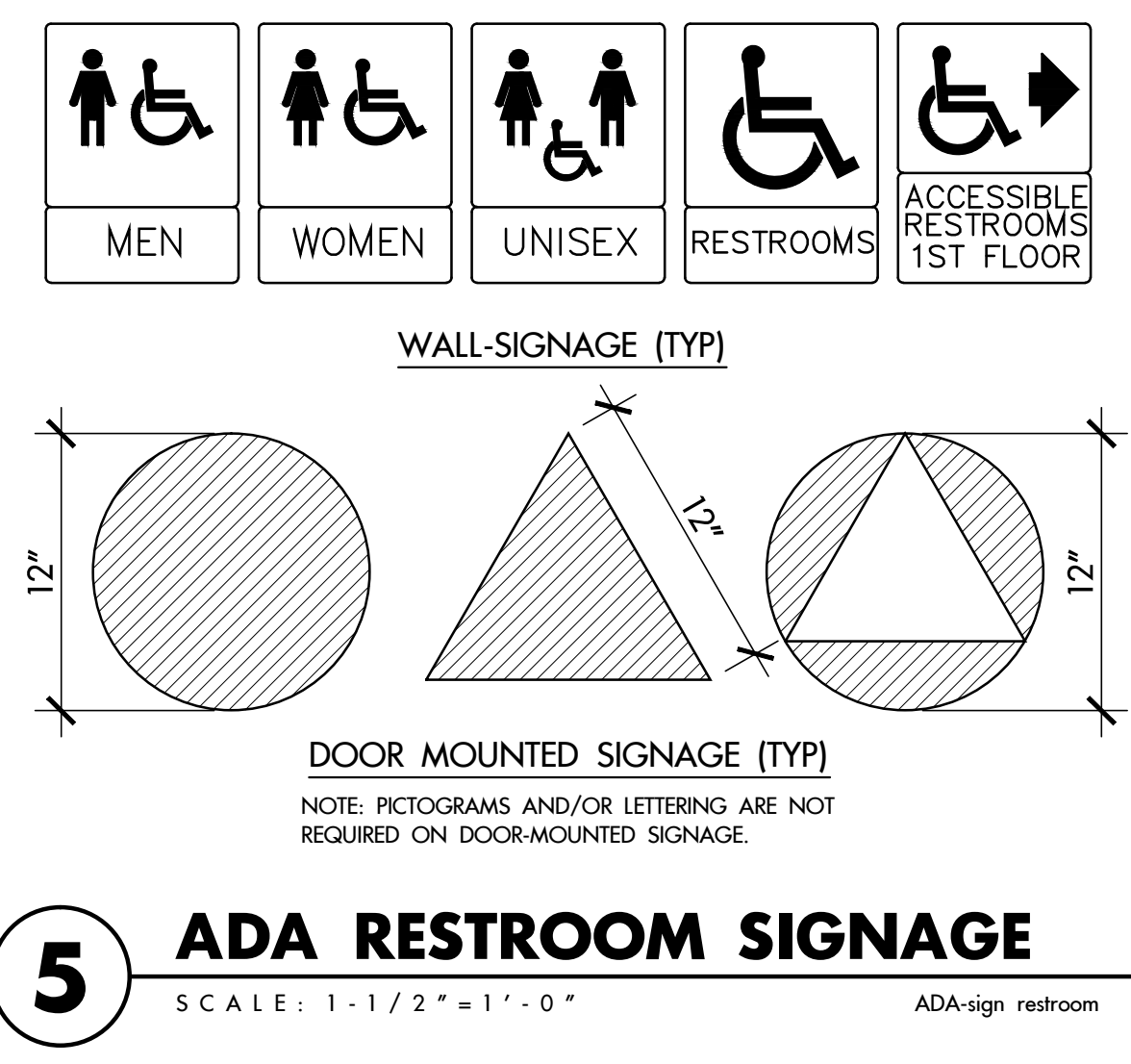
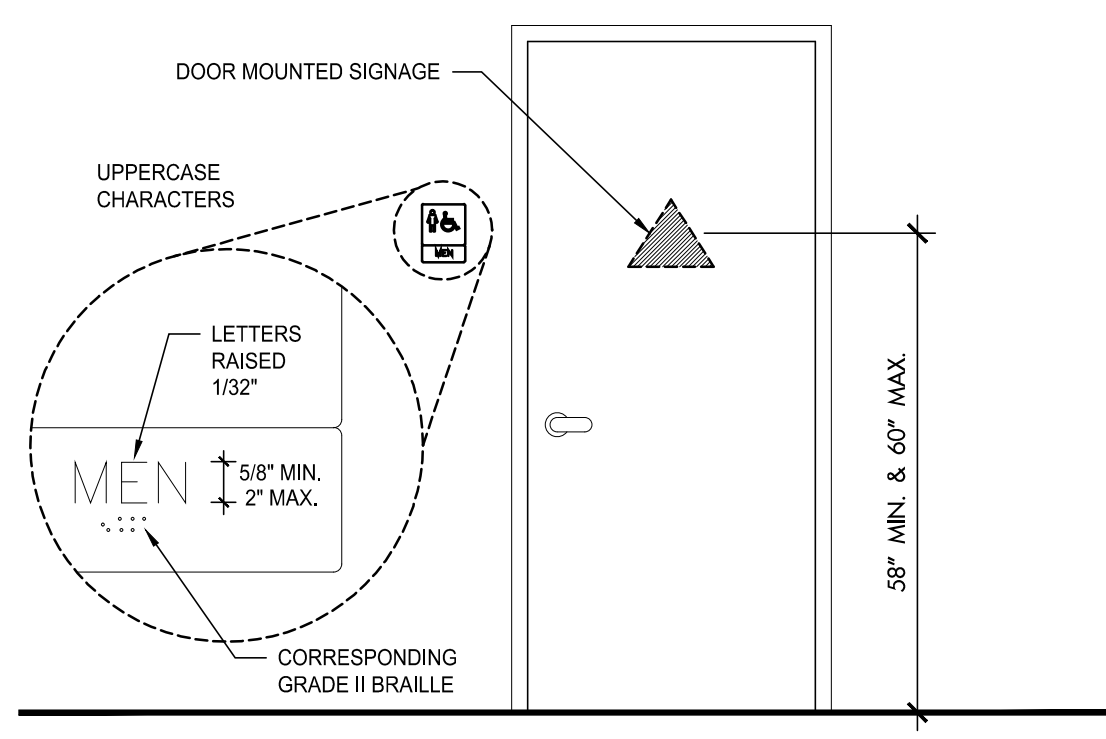

LUNA DESIGN

PO Box 1973,
 Sonoma CA 95476
 Office 707.935.8545
 Cell 415.806.6084
 www.lunadesignsonoma.com

Steve A. Moody

THESE DRAWINGS ARE THE INSTRUMENTS OF SERVICE AND ARE THE PROPERTY OF LUNA DESIGN. ALL DESIGN AND OTHER INFORMATION CONTAINED ON THESE DRAWINGS ARE FOR USE ON THE SPECIFIED PROJECT AND SHALL NOT BE USED ON OTHER PROJECTS, OR FOR ADDITIONS TO THIS PROJECT, OR FOR COMPLETION OF THIS PROJECT BY OTHERS WITHOUT FIRST OBTAINING THE EXPRESS WRITTEN CONSENT OF LUNA DESIGN. THESE DRAWINGS SHALL NOT BE REPRODUCED, CHANGED OR COPIED IN ANY FORM WHATSOEVER WITHOUT FIRST OBTAINING THE EXPRESS WRITTEN PERMISSION AND CONSENT OF LUNA DESIGN, NOR ARE THEY TO BE ASSIGNED TO ANY THIRD PARTY WITHOUT SAID WRITTEN PERMISSION AND CONSENT.

JANE DISPENSARY T.I.
 4040 HIGHWAY 12, SANTA ROSA CA 95249
 APN: 032-500-040

Date	Description

Drawn By: SM
 Date: 5/12/21
 Scale: AS SHOWN

ACCESSIBILITY

A.500

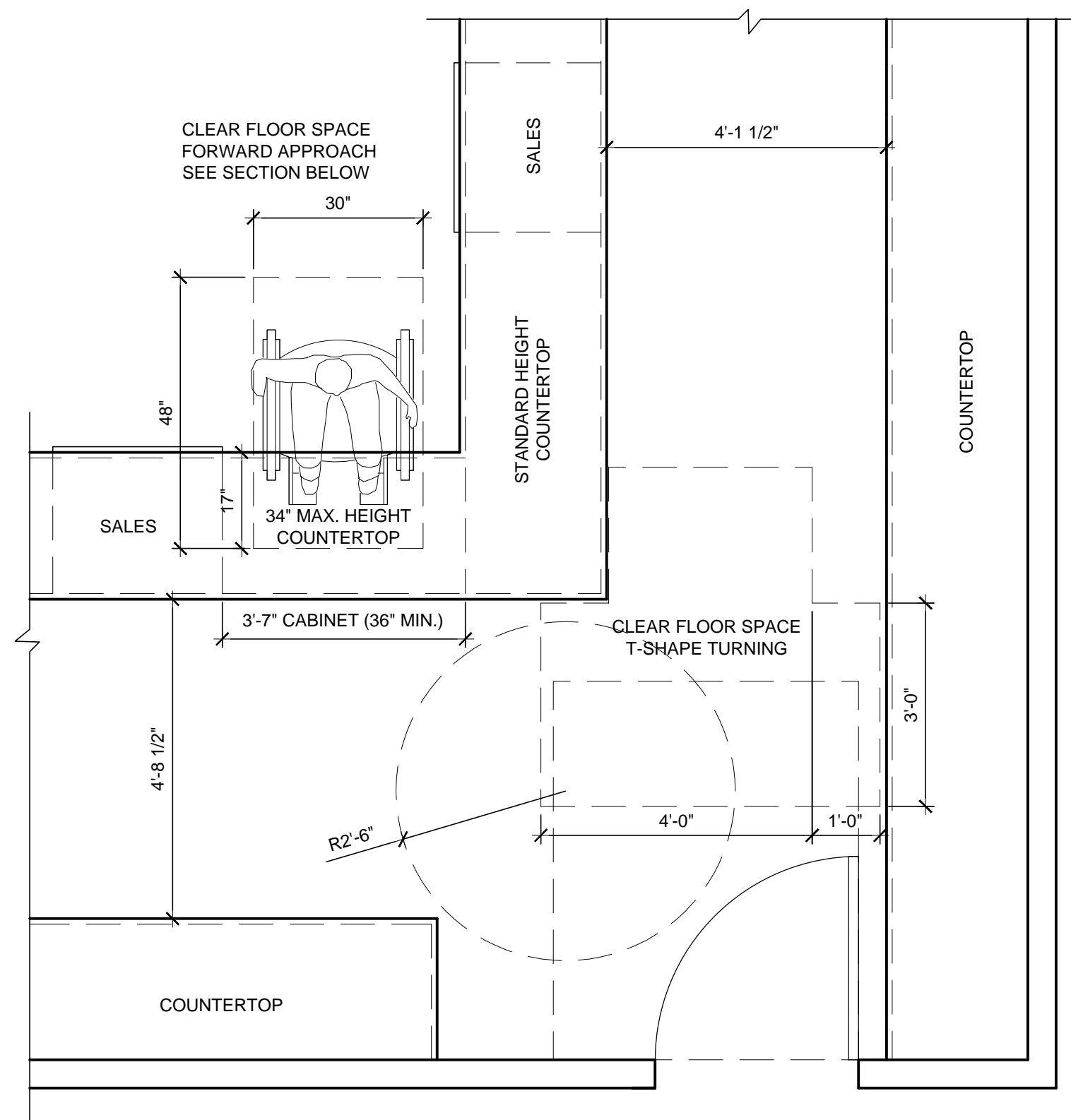

3A - ACCESSIBLE POINT OF SALE SCALE: 1/2" = 1'-0"

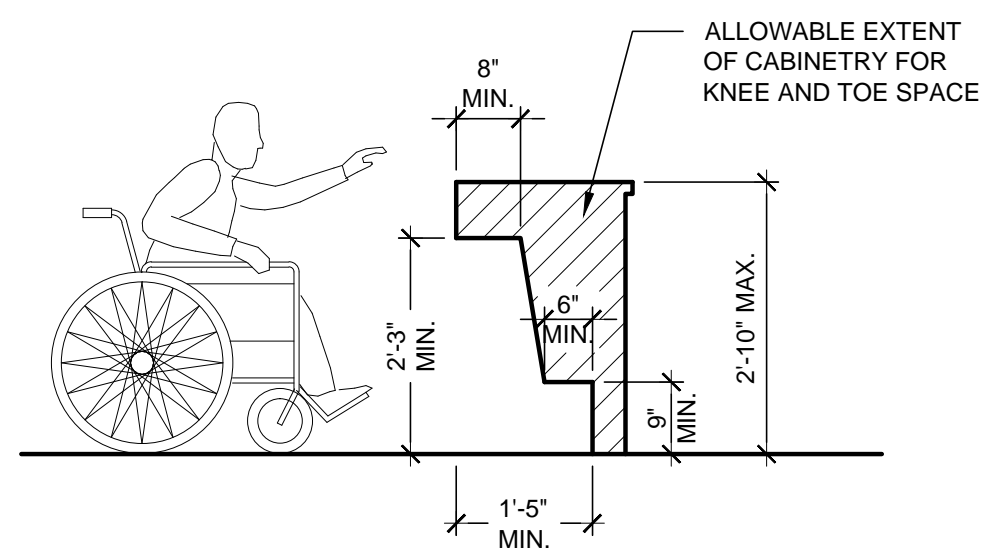

FORWARD APPROACH AT SALES COUNTER

3B - CABINETS SECTION SCALE: 1/2" = 1'-0"

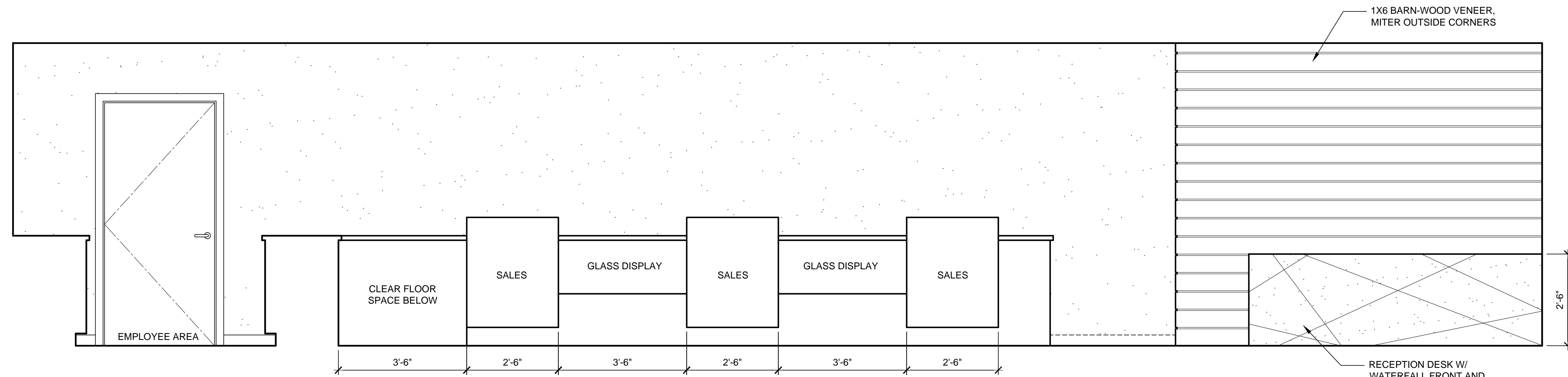

EAST SALES

SCALE: 1/2" = 1'-0"

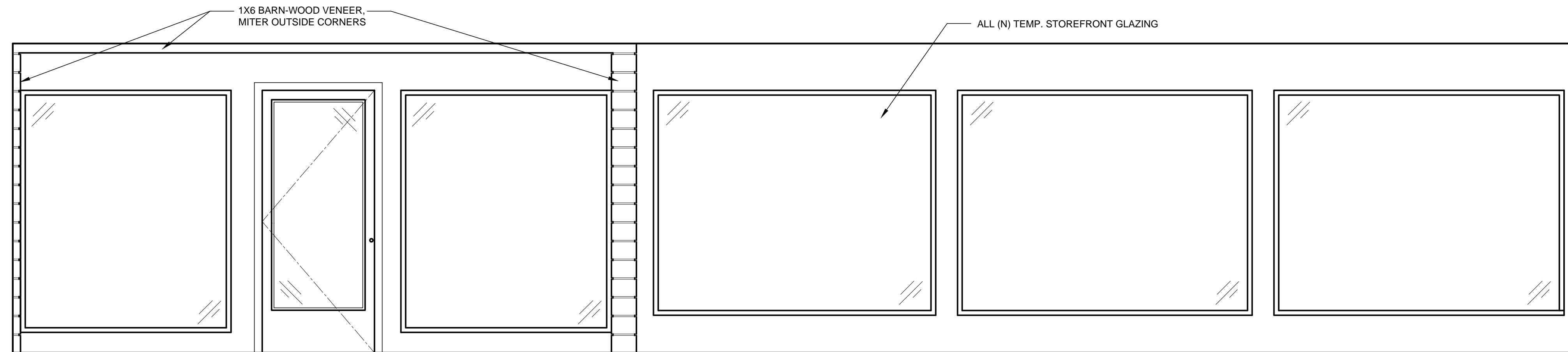

WEST SALES

SCALE: 1/2" = 1'-0"

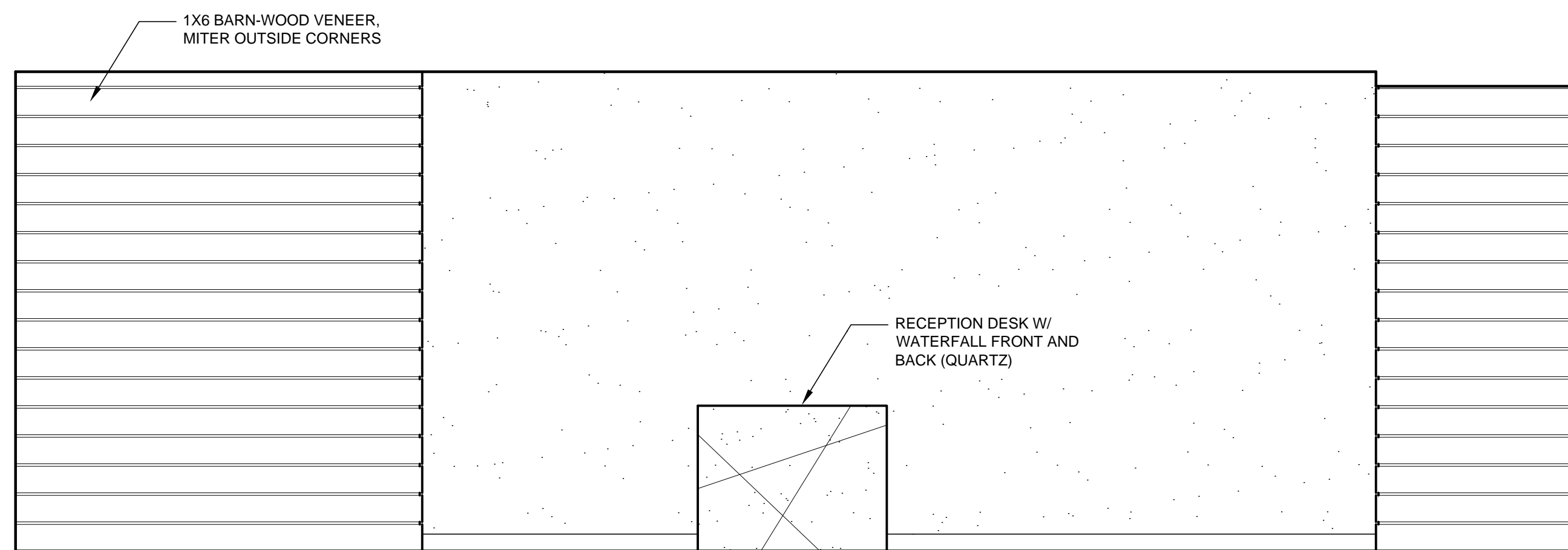

SOUTH SALES

SCALE: 1/2" = 1'-0"

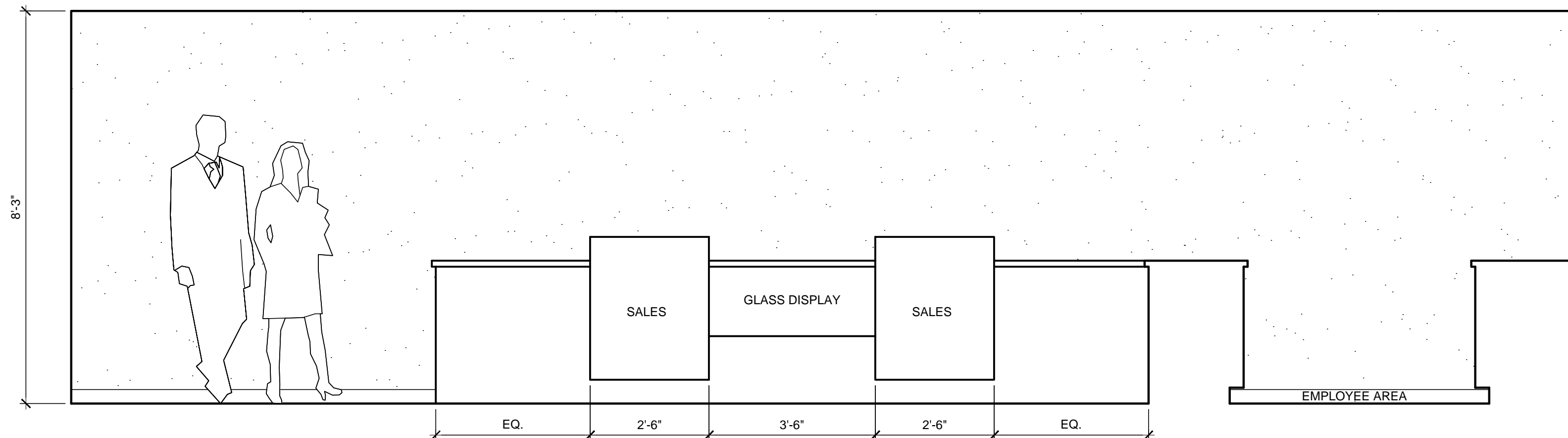

NORTH SALES

SCALE: 1/2" = 1'-0"

LUNA DESIGN

PO Box 1973,
Sonoma CA 95476
Office 707.935.8545
Cell 415.806.6084
www.lunadesignsonoma.com

Steve A. Moody

THESE DRAWINGS ARE THE INSTRUMENTS OF SERVICE AND ARE THE PROPERTY OF LUNA DESIGN. ALL DESIGN AND OTHER INFORMATION CONTAINED ON THESE DRAWINGS ARE FOR USE ON THE SPECIFIED PROJECT AND SHALL NOT BE USED ON OTHER PROJECTS, OR FOR ADDITIONS TO THIS PROJECT, OR FOR COMPLETION OF THIS PROJECT BY OTHERS, WITHOUT THE EXPRESSED WRITTEN CONSENT OF LUNA DESIGN. THESE DRAWINGS SHALL NOT BE REPRODUCED, CHANGED, OR COPIED IN ANY FORM WHATSOEVER WITHOUT FIRST OBTAINING THE EXPRESSED WRITTEN PERMISSION AND CONSENT OF LUNA DESIGN, NOR ARE THEY TO BE ASSIGNED TO ANY THIRD PARTY WITHOUT SAID WRITTEN PERMISSION AND CONSENT.

JANE DISPENSARY T.I.
4040 HIGHWAY 12, SANTA ROSA CA 95249
APN: 032-500-040

Revisions:	Rev	Description	Date

Drawn By: SM
Date: 5/12/21
Scale: AS SHOWN

INTERIOR ELEVATIONS

A.501

Steven A. Moody

THESE DRAWINGS ARE THE INSTRUMENTS OF SERVICE AND ARE THE PROPERTY OF LUNA DESIGN. ALL DESIGN AND OTHER INFORMATION CONTAINED ON THESE DRAWINGS ARE FOR USE ON THE SPECIFIC PROJECT AND SHALL NOT BE USED ON OTHER PROJECTS, OR FOR ADDING TO THIS PROJECT, OR FOR COMPLETION OF THIS PROJECT BY OTHERS WITHOUT FIRST OBTAINING THE EXPRESS WRITTEN CONSENT OF LUNA DESIGN. THESE DRAWINGS SHALL NOT BE REPRODUCED, CHANGED, OR COPIED IN ANY FORM WHATSOEVER WITHOUT FIRST OBTAINING THE EXPRESS WRITTEN PERMISSION AND CONSENT OF LUNA DESIGN, NOR ARE THEY TO BE ASSIGNED TO ANY THIRD PARTY WITHOUT SAID WRITTEN PERMISSION AND CONSENT.

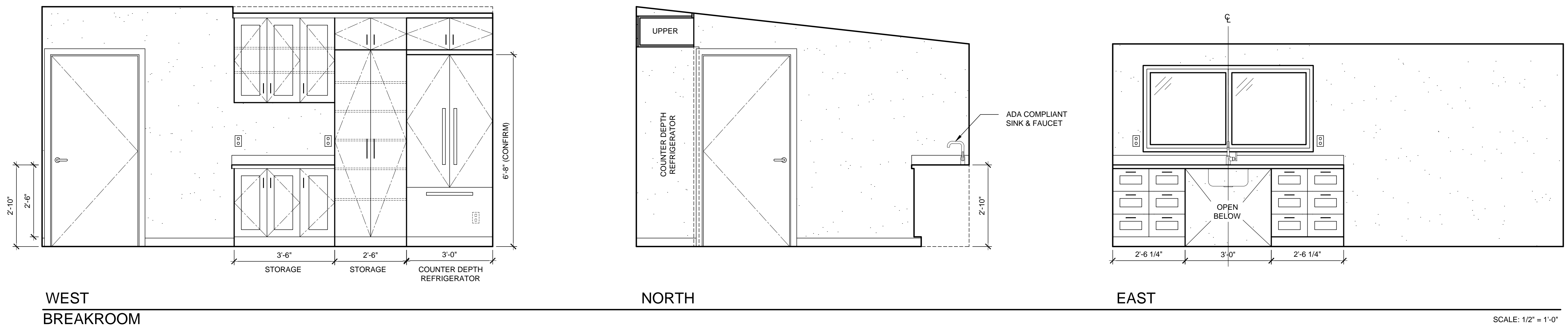
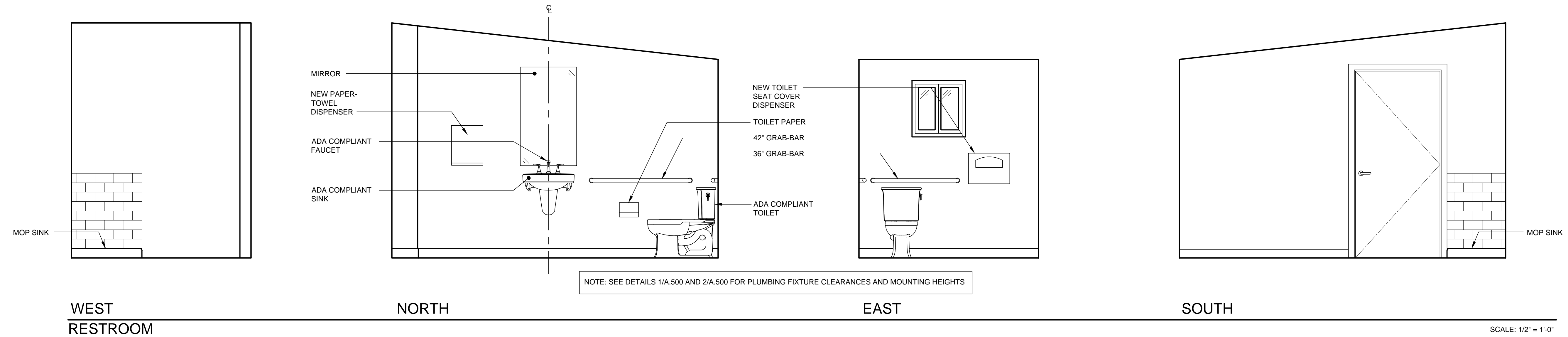

JANE DISPENSARY T.I.
4040 HIGHWAY 12, SANTA ROSA CA 95249
APN: 032-500-040

Revisions:	Rev	Description	Date

Drawn By: SM
Date: 5/12/21
Scale: AS SHOWN

**INTERIOR
ELEVATIONS**
A.502