

**APPLICATION FOR  
CONDITIONAL USE PERMIT**

**PHENOTOPIA**

COMMERCIAL CANNABIS DISPENSARY  
443 DUTTON AVENUE, SUITE 11, SANTA ROSA

## TABLE OF CONTENTS

<b>Project Summary</b>	<b>1</b>
<b>Property &amp; Neighborhood</b>	<b>2</b>
GENERAL PLAN	2
NEIGHBORING BUSINESSES	3
SENSITIVE USES	4
SETBACKS	4
VISIBILITY OF ENTRANCE	5
TRAFFIC & PARKING	5
CODE COMPLIANCE	5
<b>Business Plan</b>	<b>6</b>
COMPANY OVERVIEW	6
MISSION & OBJECTIVES	6
PRINCIPALS	7
MARKET ANALYSIS	8
TARGETED MARKETS	11
PRODUCT MIX	12
MARKETING STRATEGY	15
TRADE ASSOCIATIONS & NETWORKING EVENTS	16
FINANCIAL PROJECTIONS	17
<b>Retail Operations Plan</b>	<b>19</b>
OPERATIONAL TIMELINE	19
ORGANIZATIONAL STRUCTURE & PERSONNEL	20
HUMAN RESOURCES POLICIES	22
INTERNAL MEETINGS & REPORTING	24
SALES FLOOR OPERATIONS	24
DELIVERY; ONSITE CONSUMPTION; SPECIAL EVENTS	25
PRODUCT SAFETY	25
INVENTORY CONTROL & DIVERSION PREVENTION	25
SITE MANAGEMENT & NUISANCE PREVENTION	28
<b>Security Plan</b>	<b>29</b>
INTRODUCTION	29
PROFESSIONAL SECURITY SERVICES	29
PHYSICAL SECURITY SETTING	29
LOCKS AND ACCESS CONTROL	30

SURVEILLANCE CAMERAS	30
ALARM SYSTEM	31
SECURITY PERSONNEL	31
TRANSPORTATION	31
SECURE STORAGE & WASTE DISPOSAL	32
EMERGENCY ACCESS	33

**Odor, Light, and Noise Control** **34**

ODOR CONTROL	34
LIGHTING PLAN	34
NOISE CONTROL	35

**Neighborhood Enhancement & Community Relations** **36**

NEIGHBORHOOD ENHANCEMENT & COMPATIBILITY	36
COMMUNITY OUTREACH	39
COMMUNITY BENEFITS	39
COMMUNITY LIAISON	40
ENVIRONMENTAL BENEFITS	40

**Attachment A: Crime Alert Dispensary Facility Security Plan**

**Attachment B: AICE Odor Control Plan**

**Attachment C: Canvassing Report**

**Attachment D: Letters Of Support**

## INDEX: MERIT-BASED CRITERIA

### 1. Local & State Compliance

---

<i>State Regulations</i>	19-35; attms A, B
<i>County/regional Permit Reqs.</i>	19-20
<i>Santa Rosa General Plan Policies</i>	2-5, 36-40, 41
<i>Santa Rosa City Code Locational &amp; Operational Reqs.</i>	2-5, 19-35; attms A, B

### 2. Neighborhood Compatibility

---

<i>Neighborhood Fit</i>	2-5, 36-40, 41
<i>Odor Control</i>	34; attm B
<i>Enhanced Retail Experience</i>	24-25, 36-41; site plans
<i>Entrance; Pedestrian, Bike, &amp; Transit Orientation</i>	2,5, 36-40, 41

### 3. Neighborhood Enhancement

---

<i>Site, Building &amp; Neighborhood Improvements</i>	36-41; site plans
<i>Project Integration</i>	2-5, 36-41; site plans
<i>Environmental Benefits</i>	40-41
<i>Community Benefits</i>	39-41

### 4. Site Management

---

<i>Experience in Retail Cannabis Operations</i>	7-8
<i>Qualifications &amp; Backgrounds of Principals</i>	7-8
<i>Business Plan that includes:</i>	
<i>Day-to-day Operations</i>	19-28
<i>Tracking &amp; Diversion Prevention</i>	24, 25-28, 29-32
<i>Nuisance Management</i>	28, 32-33, 40
<i>Performance Timeline</i>	19-20



## PROJECT SUMMARY

Phenotopia<sup>1</sup> hopes to develop a vacant retail space at 443 Dutton Avenue, Suite 11, into a modern, customer-focused cannabis dispensary that will be a commercial and community anchor to the Southwest Santa Rosa/Roseland area.

The Phenotopia dispensary on Dutton Avenue will be a low-profile, but active retail cannabis operation. At full capacity, the store will employ between 10 and 15 staff and serve an estimated 100 to 200 customers per day. Dispensary hours will be 9:00 am to 9:00 pm, 7 days per week. The dispensary will provide a variety of high-quality and fully-tested brand name cannabis products in a modern, polished retail setting that is consistent with the direction of California's regulated cannabis market.

The Phenotopia team is excited for the opportunity to be a positive steward for the cannabis industry in Santa Rosa and Sonoma County and looks forward to working with state and local organizations to create a model for safe, efficient, and socially responsible cannabis retail operations.

---

<sup>1</sup> "Phenotopia" is the will be the "dba" for Wolf House Properties LLC.

## PROPERTY & NEIGHBORHOOD

443 Dutton Avenue is located to the northwest of the intersection of Dutton Avenue and Sebastopol Road in the Southwest Santa Rosa/Roseland area, a block south of Highway 12 and approximately .5 miles west of the 101 freeway. The 2.87 acre parcel contains “Dutton Plaza,” a single-story, concrete-block strip center built in 1987, and an associated parking lot.

The Dutton Plaza building is 26,288 square feet, containing 16 in-line and 2 end-cap retail units, which are served by a parking lot containing 136 customer and 18 staff (rear lot) parking spaces, including 6 ADA spaces. Phenotopia hopes to open a dispensary in suite 11, a 2,172 sq. ft. retail unit located near the middle of the strip center, and has secured a long-term lease on the unit. The currently empty space, previously occupied by the LA Styles men’s clothing store, has 23 feet of sidewalk frontage.

## GENERAL PLAN

### LAND USE DESIGNATIONS

A modern commercial cannabis dispensary aligns well with both current use designations for the Roseland area and with the vision for the area outlined in the Santa Rosa General Plan 2035 and the Sebastopol Road Urban Vision and Corridor Plan.

The Sebastopol Road Corridor holds General Plan designations for both Retail & Business Services and Medium Density Residential. Part of the area around Dutton Plaza was formerly part of independent Roseland and was annexed by the city of Santa Rosa in 2017. The majority of uses along Sebastopol Road and Dutton Avenue are Retail & Business Services, including all of the parcels surrounding Dutton Plaza.

As described in the Land Use & Livability Element, Sebastopol Road is the commercial focal point of southwest Santa Rosa, which is buoyed by its “pedestrian orientation.” General Plan 2-1. Sebastopol Road is also designated a Priority Development Area for increased residential density (General Plan 4-64), which would bring an increased retail customer base for high-traffic retail uses such as a dispensary.

### SEBASTOPOL ROAD URBAN VISION & CORRIDOR PLAN

Phenotopia’s mid-sized cannabis dispensary will also be consistent with the Sebastopol Road Urban Vision and Corridor Plan, which aims to “develop the Sebastopol Road area – from Stony Point Road to Dutton Avenue – with a mix of neighborhood uses, focusing on commercial activity and neighborhood services for the Roseland area.” General Plan 2-29, LUL-X.

A key aspect of the Sebastopol Road Plan is the development of the Roseland Village Shopping Center into a vibrant commercial center with strong pedestrian and bike connections to the Joe Rodota Trail. Should that plan come to fruition, Phenotopia will have an amazing opportunity. Being virtually adjacent to the planned development on the north side of Sebastopol Road, our own bike and pedestrian connections to the Joe Rodota Trail will create an easy connection to the new urban center.

---

## ECONOMIC DEVELOPMENT & VITALITY

As referenced briefly in our Business Plan’s marketing strategy, Phenotopia plans to develop several supply chain facilities in and around Santa Rosa as part of a broader strategy to create a vertically-integrated local business. By pairing the Dutton Avenue dispensary with local facilities for cultivation, manufacturing, and distribution, we hope to develop a cannabis brand that will be scalable throughout the state and licensable in other legal cannabis jurisdictions.

Both the Phenotopia dispensary itself, as well as our broader company goals, support most of the economic development goals set forth in the Economic Vitality Element of the General Plan.

The dispensary supports the “commercial revitalization” aspects of the Roseland Redevelopment Plan (General Plan 10-5), as well as the City’s intent to promote retail along the regional/arterial corridors, a designation that applies to both Sebastopol Road and Dutton Avenue. General Plan 10-6, 5-24, 5-25. As our management team is committed to local hiring, both the dispensary and our integrated supply chain operation centered on Santa Rosa will create dozens of local jobs. And, as envisioned by Goal EV-B-2, these jobs are particularly valuable in that they will utilize the area’s existing talent pool, which is rich with workers experienced in the retail and agricultural industries. General Plan 10-6.

## NEIGHBORING BUSINESSES

Tenants in Dutton Plaza are a mix of commercial retail tenants:

- Joyeria Torres Soccer Sport
- Do!Ex
- Prime Time Nutrition
- Mas x Menos
- Máximo Insurance & Tax Service
- The Jelly Donut
- Cancun Mexican Restaurant
- BoostMobile
- Dutton Coin Laundry
- Angel’s Hair
- Calzado Leon
- Apoyo Financiero
- O! Sushi
- Colores Ice Cream and Cake
- SR Foods

In addition, a Jack In the Box restaurant occupies a smaller, half-acre parcel—425 Sebastopol Road—that is carved out of 443 Dutton Avenue and sits directly on the Dutton Avenue/Sebastopol Road intersection.

This portion of Sebastopol Road and it’s adjacent blocks, including Dutton Avenue, is a mixed commercial corridor with significant retail uses. Neighboring business outside of Dutton Plaza include the following:

**To the North:**

- Cattleman’s

**To the West:**

- El Farolito Taqueria
- Chula’s Party Supply & Floretia

**To the South (across Sebastopol Road):**

- Exchange Bank
- Astorga’s Auto Repair
- Frozen Art
- Fiesta Auto Insurance
- Tacos Al Carbon
- Salon California

**To the East (across Dutton Avenue):**

- Lola’s Market
- Hernandez Mufflers
- Fidel’s Auto Repair
- Luis Auto Sales
- CJ Tires
- Shell Gas

**To the Southeast (across Sebastopol/Dutton intersection):**

- 76 Gas/7-11

**SENSITIVE USES**

No sensitive uses exist within 600 feet of the Dutton Plaza parcel. The closest qualifying sensitive use is Roseland Elementary, the closest parcel line of which is approximately 800 feet from the southwest corner of the Dutton Plaza parcel.

**SETBACKS**

Dutton Plaza’s setbacks and property layout are consistent with the surrounding neighborhood, with most parcels occupied by retail plaza configurations, with ample parking lots to serve the high number of retail businesses and limited street frontage.

At its closest points, the Dutton Plaza retail strip is set back 86’-2” from Sebastopol Avenue and 85’-2” from Dutton Avenue. The rear portions of the building are a minimum of 24’-11” from the northern property line and 23’-0” from the western property line. Phenotopia will occupy an in-line unit in the middle of the retail strip, with the rear wall of the dispensary no less than 33’-0” from the western property line and the front of the store approximately 200 feet from Dutton Avenue.

## VISIBILITY OF ENTRANCE

Phenotopia will occupy a retail unit that faces the intersection of Sebastopol Road and Dutton Avenues on a 45 degree angle. The result is clear lines of sight to the entrance from both streets, with the exception of a portion of Sebastopol Avenue—approximately 80 feet long—where the Jack in the Box restaurant blocks one’s view from the street. Trees line much of Dutton Plaza’s street-facing property lines, but the foliage is well-kept with few branches below 10 feet above the ground, well outside of the ‘2-foot, 6-foot rule’ commonly recommended by law enforcement agencies.

The Dutton Plaza parking lot, with entrances on both Sebastopol and Dutton Avenues, occupies virtually the entire area between the retail building and the streets, allowing law enforcement an unimpeded drive up to within 20 feet of the dispensary’s front entrance.

## TRAFFIC & PARKING

The Dutton Plaza parking lot has two-way entrances/exits on both Dutton Avenue and Sebastopol Road. There are 136 customer spaces, including 6 ADA-accessible spots, serving 18 retail stores in the plaza. An additional 17 dedicated employee spaces are located in the rear of the building, along with multiple parallel parking spots along the back of the retail units. Because of the substantial employee and customer parking and the low-volume nature of some of the tenant businesses, the parking lot is more than sufficient.

The property is served by routes 2 and 12 of Santa Rosa City Bus and route 22 of Sonoma County Transit, with a stop located at the Dutton Avenue/Sebastopol Road intersection. The rear of the plaza also abuts the Joe Rodota Trail, with direct bike and pedestrian connections between the Trail and Dutton Plaza’s storefront walkways.

## CODE COMPLIANCE

Phenotopia will obtain all building, fire and CUPA permits before required for our planned interior construction and a dispensary operation in our existing retail building. All design work will be conducted by professionally licensed engineers and architects and all plans submitted for building and other permits will be signed and stamped by the same. We have reviewed in detail the City-provided document on “Building and Fire Code Requirements for Cannabis Related Occupancies” and all construction and operational plans will be in strict compliance with those guidelines and the code provisions referenced therein.

# BUSINESS PLAN

## COMPANY OVERVIEW

The Phenotopia dispensary on Dutton Avenue will be a low-profile, but active retail cannabis operation. At full capacity, the store will employ between 10 and 15 staff and serve an estimated 100 to 200 customers per day. Dispensary hours will be 9:00 am to 9:00 pm, 7 days per week.

The dispensary will provide a variety of high-quality, brand-name cannabis products meeting the Bureau of Cannabis Control's testing and quality assurance regulations. As permitted by Santa Rosa's cannabis ordinance, products will include cannabis flower, extracts, edible and topical products.

The planned sales floor would occupy the front 1,100 sq. ft. of the retail unit, with display cases around the outside of the room and a service/sale counter extending from the rear wall into the middle of the room. Inventory will be stored in a fully sealed and secure room at the rear of the unit, and a security/reception kiosk will occupy the entryway. Little change will be made to the store facade, which currently has 10 feet of large, retail window panels and double glass entry doors. Dispensary signs will be wall-mounted, internally lit, and located along the strip center awning. Per tenant rules of the strip center, any signage will be similar in size, palette and appearance to those already present. Exterior lighting will also comply with property owner-enforced rules, and will be appropriate for nighttime visibility by police and security staff.

## MISSION & OBJECTIVES

Our goal is to create the premier cannabis brand in the state of California focused on quality, customer service, and safety. Beyond selling cannabis products, we plan to provide education on the benefits of cannabis for health and general well-being. We are dedicated to providing economic opportunities for local citizens to participate in a burgeoning industry. We will lead the local cannabis community in charitable giving and community outreach programs to groups and organizations which can benefit from responsible use of cannabis.

Our objectives are five-fold:

1. Permitting & Licensing: Obtain a retail permit from The City of Santa Rosa and a retail license from the State of California.
2. Design & Building: Safe, environmentally-friendly, retail facilities that comply with Santa Rosa Building and Fire Codes and enable the provision of cost-effective, commercial grade cannabis and cannabis infused products.
3. Industry standard: Our goal is to create the model that raises the bar for all other operations. We aim to serve as a best practices resource for local governments and agencies looking to learn more about this industry.
4. Economic Stimulus: We will help improve the economy of Santa Rosa and Sonoma County. Including increased jobs in the supply chain, the proposed dispensary will bring roughly 20 new jobs to the area once at full capacity. We will help Santa Rosa to fully participate in the

evolution of the Cannabis industry, further establishing Santa Rosa as a destination for cannabis entrepreneurs in a growing economy.

5. Community Outreach: We will partner with local organizations aligned with the cannabis industry to leverage donations of time and money towards organizations benefitting our neighborhood.

## PRINCIPALS

### PADRAIC FAHEY, FOUNDER AND CEO

---

Padraic Fahey is a seasoned cannabis Cultivator and Buyer who has been working with established dispensary operators since 1996.

A long-time resident of Santa Rosa, but a native of Napa County, Padraic grew up in a large family (seven siblings) surrounded by the burgeoning wine industry. He began his journey into cannabis culture and cultivation while studying classics at the University of California at Berkeley. Building on humble beginnings working with and around cottage cultivators, Padraic soon became an innovator in large-scale indoor cannabis cultivation, designing, building and managing grow facilities during the formative years of California's medical marijuana movement. In addition, Padraic spent nearly 5 years as a Buyer and Supply Chain Consultant to several large Southern California dispensaries. In over 20 years in the industry, he has developed strong family and business ties throughout the emerald triangle counties of Sonoma, Mendocino, and Humboldt and brings a deep knowledge of nearly every aspect of the evolving cannabis marketplace.

In his spare time, Padraic can be found playing chess and traveling with his wife and their two young children.

### JOHNNY NOLEN, CHIEF OPERATING OFFICER

---

*Strategist + COO, 421 Group*

Johnny is Strategist and COO at 421 Group. Striking the perfect balance between data-driven and people-focused, Johnny sets a new standard for professionalism in the cannabis industry.

Johnny is a veteran of San Francisco's pre-regulation era with 14 years of leadership experience in the industry. Most recently, Johnny served as Vice President of Operations of the SPARC and Peace in Medicine family of companies, managing all retail, cultivation, manufacturing, and distribution operations for two of the Bay Area's most successful cannabis dispensaries. Armed with analytics-based insights, he has fearlessly taken cannabis companies from struggling businesses to successful, cash-positive enterprises. With a background in Biochemistry and Molecular Biology, Johnny has a passion for building dynamic, integrated systems that are effective and intuitive to manage. His proven operational strategy ensures organizational longevity by championing financial and ecological sustainability, prioritizing employee-positive workspaces, and delivering outstanding customer service at every turn.

In his free time, Johnny enjoys maintaining a strict bodybuilding routine and running a local tabletop-gaming group focused on diversity and inclusivity.

## CRAIG LITWIN, PUBLIC AFFAIRS ADVISOR

---

*Principal + President, 421 Group*

Craig is the President of 421 Group, a boutique consultancy serving innovative cannabis organizations in California. A seasoned political consultant and cannabis activist since 1994, Craig brings over 20 years of experience in the field.

A top signature-gatherer for Proposition 215, Craig went on to become a Sebastopol councilman and mayor, co-authoring one of the nation's first dispensary ordinances. He's testified before county supervisors throughout the state and has been a driving force behind Santa Rosa's dispensary and cultivation ordinances and Clearlake's rejection of a cultivation ban. Craig's talent for designing and implementing sound policy—and skillfully engaging policymakers, community leaders, and law enforcement—makes him a strong ally. A champion of permaculture, Craig holds a BA in Ecology with Sustainability emphasis.

In his free time, Craig can be found outdoors with his family enjoying nature and looking for chanterelle mushrooms.

## DREW MILLER, LEGAL COUNSEL & CHIEF COMPLIANCE OFFICER

---

*Senior Associate Attorney & Policy Advisor, Anthony Law Group*

Drew is Senior Associate Attorney and Policy Advisor at Anthony Law Group, one of California's first law offices to focus exclusively on cannabis law and public policy, and serves as Phenotopia's Legal Counsel and Chief Compliance Officer.

Drew is a long-time policy strategist and legal advisor on issues affecting regulated businesses, having spent 10 years in Washington, DC working on regulatory policy at the state, federal, and international levels. He has held multiple government affairs roles inside and outside of government and, immediately prior to joining Anthony Law Group, led a series of U.S. Government projects to improve regulatory environments in Asia and the Middle East.

Since joining Anthony Law Group in 2016, Drew has advised hundreds of cannabis clients on strategic planning, regulatory compliance, and government relations in California's evolving cannabis regulatory environment. Drew's clients include over a dozen Bay Area cannabis dispensaries, and commercial cultivators, distributors, manufacturers, and investors throughout the state.

Drew's weekends are spent surfing and/or hiking with his wife around Northern California.

## MARKET ANALYSIS

---

### THE GENERAL CANNABIS MARKET

Legal marijuana sales are predicted to hit \$9.7 billion across the seven states where recreational marijuana is legal, excluding California, and Canada in 2017 alone.<sup>2</sup> That number is expected to hit \$24.5 billion in sales by 2021, despite continued federal prohibition.<sup>3</sup>

---

<sup>2</sup> Source: BDS Analytics



## STATES WHERE MARIJUANA IS LEGALIZED

■ Legalized marijuana   
 ■ Legalized medical marijuana   
 ● Legislation passed Nov. 2016

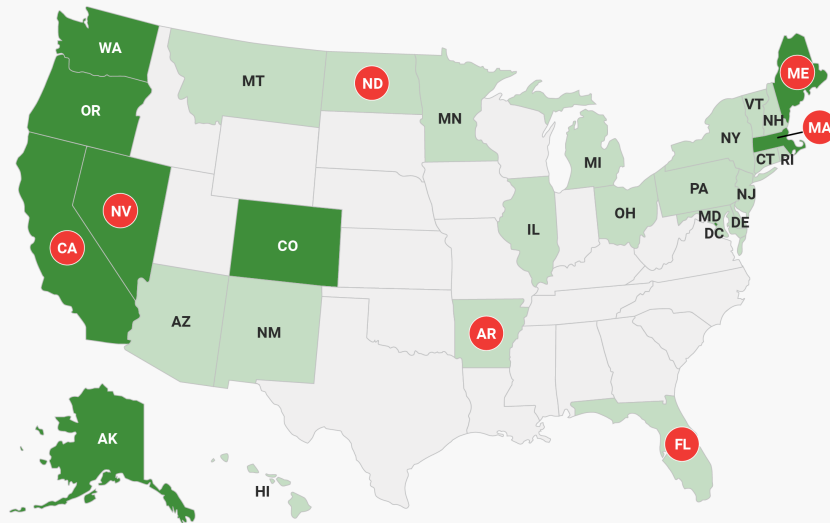

SOURCES: Politico; Reuters

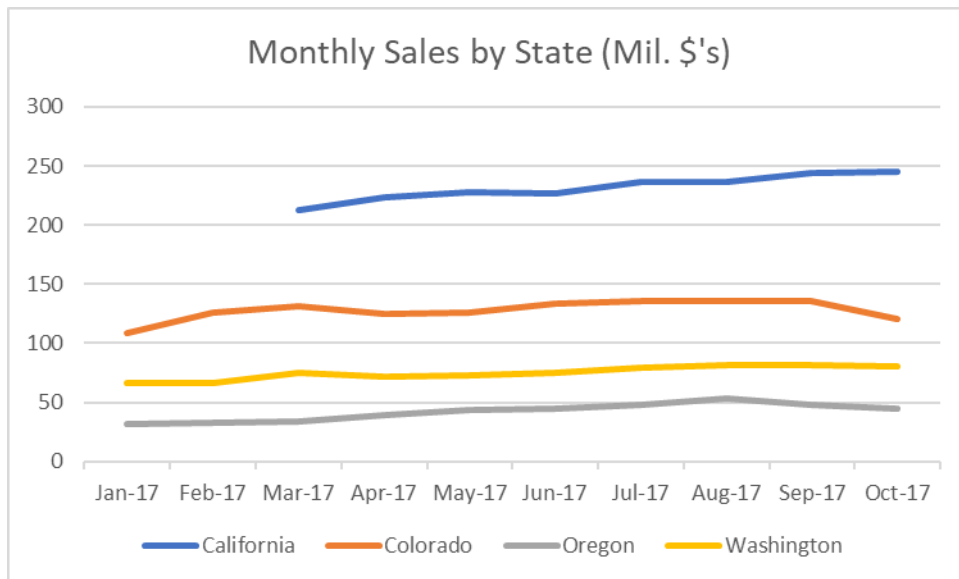

(Source: BDS Analytics)

<sup>3</sup> Source: Business Insider

## THE CALIFORNIA CANNABIS MARKET

Rapid expansion in the cannabis market is expected, with the California market moving from a projected \$2.81BN in 2015 to \$6.45BN by 2020- making it the largest state marijuana market in the nation. Over the same period, the national market is projected to grow from \$7.3 billion to \$20.7 billion.<sup>4</sup>

For comparison, beer sales in California hit \$5 billion in 2017, according to industry research group IBIS World. California — the world's sixth largest economy with a population of close to 40 million — will be a huge chunk of the total market for cannabis in North America. Sales of cannabis in California will hit \$3.7 billion in 2018 alone, and that number will increase to \$5.1 billion in 2019 as more dispensaries come online.<sup>5</sup>

Graph: California's Legal Marijuana Market

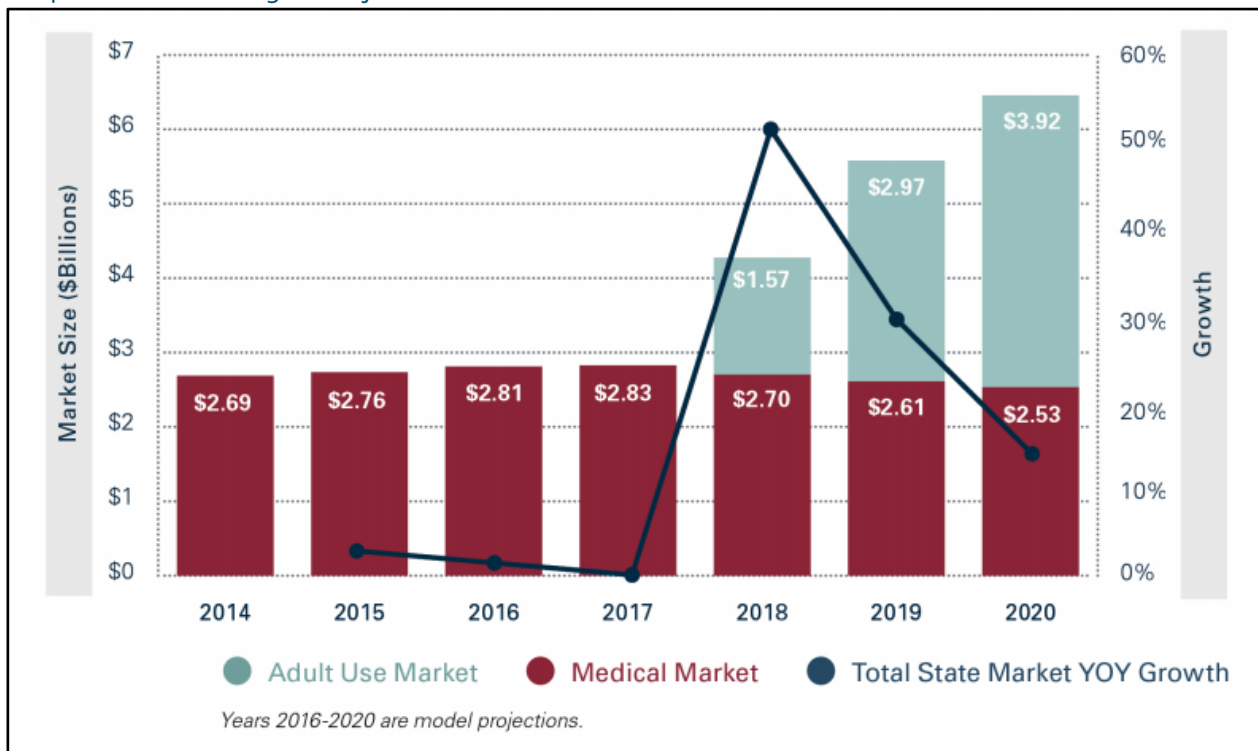

(Source: New Frontier)

<sup>4</sup> Source: New Frontier/Arcview

<sup>5</sup> Source: New Frontier

## TARGETED MARKETS

---

### RETAIL

Sonoma County (population +/- 502,000) is currently served by 10 dispensaries, with an 11<sup>th</sup> recently approved but unopened. By comparison, there are approximately 20 dispensaries in Alameda County<sup>6</sup> (population 1,500,000) with at least 20 more coming on line in 2018.<sup>7</sup> There is no current cap on the number of dispensaries which can be licensed in Sonoma County and its incorporated cities, but our analysis shows that the area can support dozens more dispensaries than the current number due to both population size and tourism.

### LOCAL DISPENSARIES

- SPARC (Santa Rosa)
- Sonoma Patient Group (Santa Rosa)
- Alternative Dispensary and Delivery (Santa Rosa)
- Redwood Herbal Alliance (Sonoma County)
- Sonoma Medicinal Herbs (Sonoma County)
- OrganiCann (Sonoma County)
- Riverside Wellness (Sonoma County)
- Down Under Industries (Sonoma County)
- Peace in Medicine (Sebastopol)
- Solful (Sebastopol)
- Mercy Wellness (Cotati)

### DEMOGRAPHICS

The demographics of the Santa Rosa metro area are well-suited to cannabis purchase and consumption. Santa Rosa (and Sonoma County in general, including nearby Petaluma) feature a robust population of target customer 18 years of age or older. The two major metros in the area and the county as a whole feature incomes greater than the California median of \$61,320. Further, the metro areas feature strong retail sales per capita.

- Santa Rosa:
  - Median Household Income (2016): \$62,705
  - # of People 18+: 133,000
  - Retail Sales per Capita: \$16,507
- Petaluma:
  - Median Household Income: \$80,907
  - # of People 18+: 46,000

---

<sup>6</sup> Source: Weedmaps

<sup>7</sup> Oakland: 8, San Leandro: 1, Alameda: 2, Hayward: 3, Union City: 3, Unincorporated: 3.

- Retail Sales per Capita: \$14,856
- Sonoma County:
  - Median Household Income: \$66,833
  - # of People 18+: 393,000
  - Retail Sales per Capita: \$12,233

## PRODUCT MIX

Phenotopia will specialize in safe, effective and consistent cannabis and cannabis infused products, produced under strict production guidelines, lab tested for purity and potency and packaged in tamper-proof and child-resistant packaging. Provided is a list of products/services produced and offered for retail sales.<sup>8</sup>

## RAW CANNABIS

Unprocessed plant material that has been trimmed, dried and cured. This can be vaporized or further processed by patients. We will offer raw cannabis different ratios of THC, CBD and other cannabinoids to offer options for targeting specific symptoms of approved medical conditions.

Our menu offerings will focus on unique strains, specializing in educating customers about the terpene profiles and the characteristic effects of these non-THC compounds found in cannabis. Terpenes and other “smell molecules” found in cannabis are in fact identical to those found in other herbs, spices, and fruits. These compounds make up the primary substance of essential oils and are used to produce targeted effects in aromatherapy and botanical cosmetic products. These less recognized components of cannabis are what we believe differentiates the type of truly refined experience that we believe our future customers are looking for but have not had the ease of access because the focus is often so heavily laid on the primary cannabinoids.

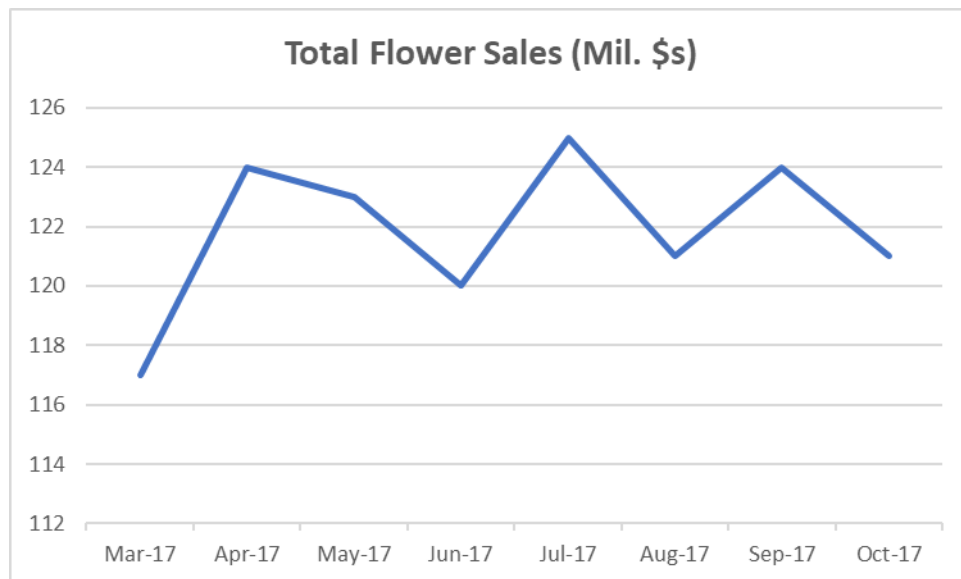

<sup>8</sup> All sales numbers are for California only (Source: BDS Analytics)

---

## CONCENTRATES

Refined products that are created by stripping cannabinoids, terpenes and other compounds from plant material with a solvent or other process. This process will yield a product that is 50%-90% pure cannabinoids. Concentrates can be consumed through vaporization, ingested, used topically or they can be infused into other product offerings. Margins depend on the end-product and the quality of the concentrate.<sup>9</sup>

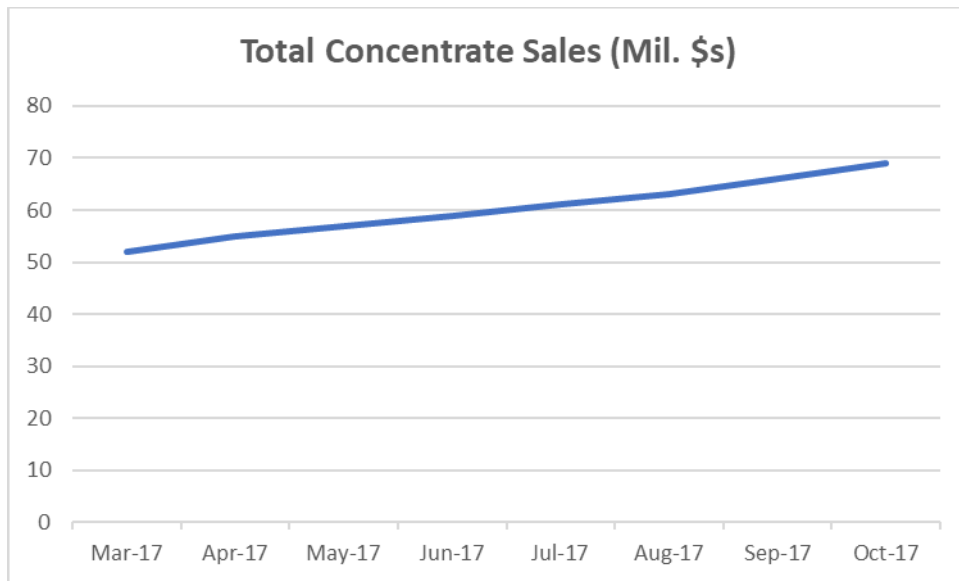

---

## TOPICALS

Infusing these products with cannabis and cannabis extracts provides relief from symptoms without any psychoactive effect. This market segment has leveled off as margins have softened, although it does feature many repeat customers.

---

<sup>9</sup> Typical gross margins in the cannabis industry are 50%, although variability is expected as the legal market matures

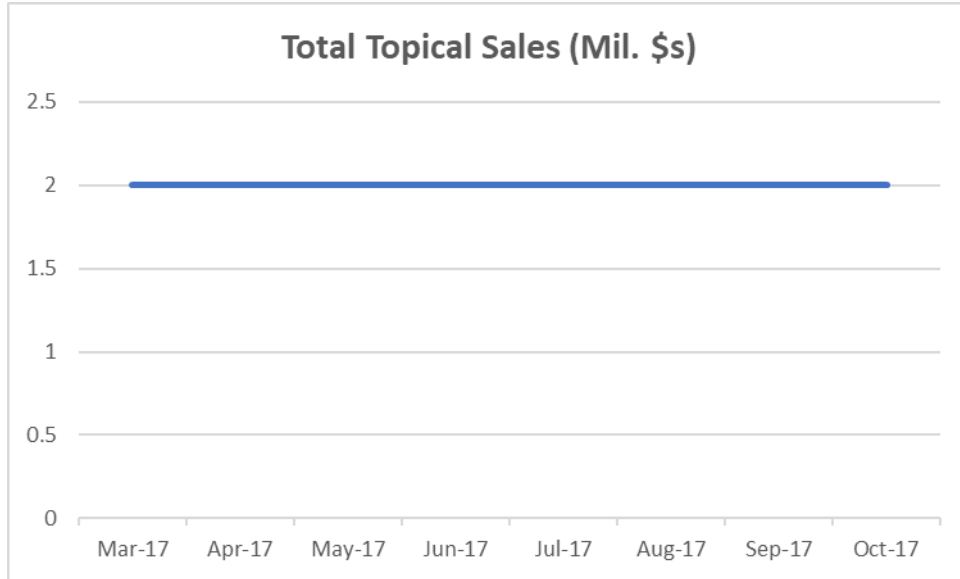

---

## EDIBLES

Edible products are an increasingly popular way to consume cannabis. If prepared safely (properly titrated in commercial kitchens), edibles are a very effective way of consuming cannabis in a carefully dosed manner with a long-lasting effect. Common edibles types include: brownies, gummies, cookies, chocolates, and other confections. Product mix is important, but the category features good margins.

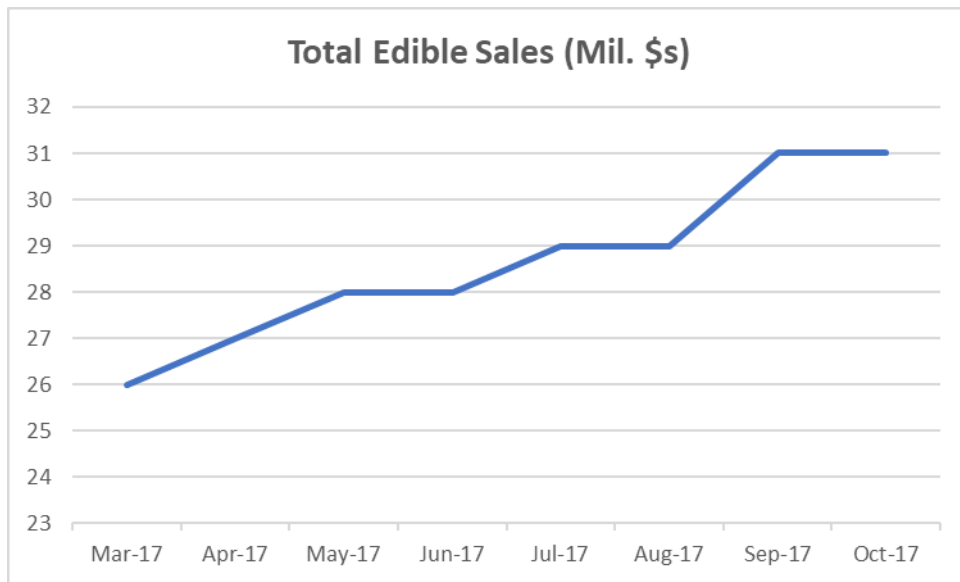

---

## PRE-ROLLS

Pre-rolled cannabis joints are a great example of a convenience product which allows traditional cannabis consumers to consume cannabis in a familiar way. Modern technology (trimmers, rolling machines) allow for a cost-effective solution. Margins are excellent as pre-rolls can be sold in a multi-pack or individually.

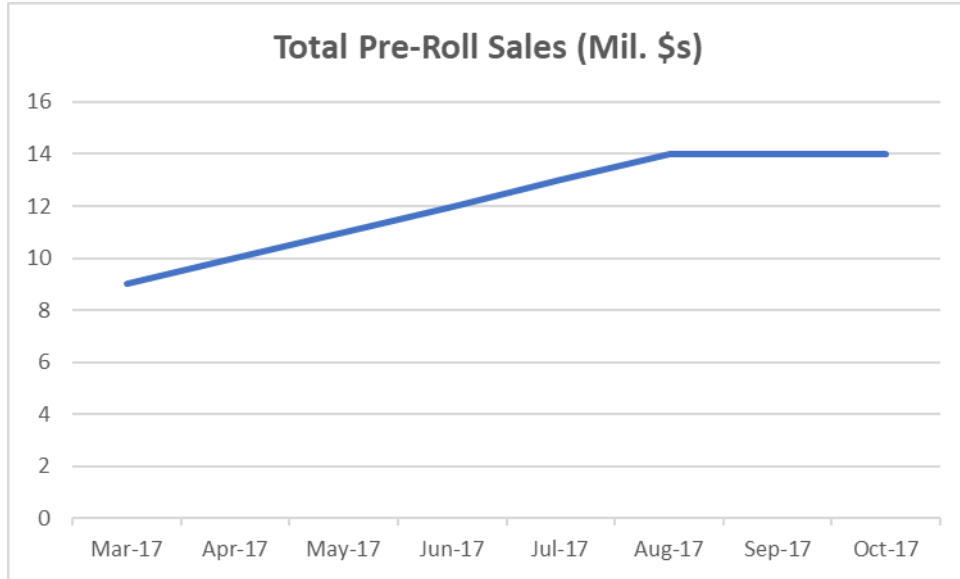

## MARKETING STRATEGY

Phenotopia will reach customers and patients through a multi-faceted sales, marketing and community outreach programs consisting of: dispensary sales force, strategic partnerships, charitable events, informational seminars, email/web marketing, social media, expos and seminars, speaking engagements, and industry networking events. We will manage and organize these campaigns to highlight our meticulous customer-focused approach to cannabis retail operations as well as our desire to make a positive impact for our customers, our community and our State.

---

## DISPENSARY SALES TEAM

Our sales team will be well trained in customer service and completely knowledgeable in every aspect of medical and adult use cannabis. Effective campaign management will turn into account management as lasting relationships are formed with our customers. Our sales team will merge tried and true techniques with new web and email based strategies to develop a comprehensive sales approach designed not only to procure new clients but increase brand awareness and goodwill for Phenotopia locally and throughout California as well.

---

## STRATEGIC PARTNERSHIPS

Phenotopia will seek to develop additional properties in the Santa Rosa area into an advantageous vertical supply chain. We view ourselves as a potential strategic resource for licensed vendors throughout California. Partnering with vendors through preferred vendor programs and/or guaranteed purchase contracts will allow us to anticipate and adapt to production demands, secure guaranteed purchases, and provide security and consistency for dispensaries and their customers. We are evaluating partnerships and licensing agreements that will allow us exclusive technologies, products and distribution rights throughout the state. These partnerships can allow for distribution rights to well known in-demand products, disruptive technologies and delivery methods sold and distributed

exclusively by Phenotopia. Ultimately, our goal is to provide high quality, safe, consistent, and advanced cannabis solutions to customers and patients.

---

### TRADE SHOWS & INFORMATIONAL SEMINARS

Phenotopia will be visible at targeted industry trade shows and informational seminars locally, nationally and abroad. These shows provide retailers and processors an opportunity to view upcoming products and chat with a spokesperson from the company, as well place orders. It also a great time for company owners and representatives to speak about the company’s core values and commitment to strengthening the industry as partners rather than competitors. Members of the Phenotopia leadership team will embrace the opportunity to speak and join panels as “Industry Experts” leading to increased credibility and awareness throughout the industry and community.

---

### EMAIL & WEB & SOCIAL MEDIA MARKETING

Phenotopia will develop an informational website that includes a current catalog of offerings for retail customers, as well as detailed product descriptions and other resources for patients. This will be the most up-to-date source of product information and availability. All advertising activities and trade show presence will highlight the website as an indispensable source of information. We will maintain an expansive email database that will provide information, announcements, promotions and product updates to customer. Beyond our website we will take advantage of professionally managed social media campaigns designed to connect, educate and update cannabis patients throughout California. We will cross-promote and link all of our online campaigns including social-media, email campaigns and website- creating unified communications highlighting our commitment to quality, patients and community.

### TRADE ASSOCIATIONS & NETWORKING EVENTS

As cannabis industry veterans, Phenotopia team members are actively involved in cannabis industry trade associations such as the California Cannabis Industry Association (CCIA), National Cannabis Industry Association (NCIA), California NORML, Sonoma County Growers Association (SCGA), Sonoma County Americans for Safe Access, and others. We view our participation and activity in the broader cannabis community to be crucial for generating awareness of our brand and continued partnership and supplier opportunities.



## FINANCIAL PROJECTIONS

<b>Retail Pro Forma</b>						
	<b>2018</b>	<b>2019</b>	<b>2020</b>	<b>2021</b>	<b>2022</b>	<b>2023</b>
<b>Retail Upfront Capital Investment</b>	<b>(\$276,324)</b>					
<u>Revenue</u>						
Flower Revenue	\$161,000	\$1,932,000	\$2,386,020	\$2,789,808	\$3,147,252	\$3,461,977
Concentrate Revenue	\$120,000	\$1,440,000	\$1,778,400	\$2,079,360	\$2,345,778	\$2,580,356
100mg Infusion Revenue	\$90,000	\$1,080,000	\$1,333,800	\$1,559,520	\$1,759,334	\$1,935,267
10mg Infusion Revenue	\$30,000	\$360,000	\$444,600	\$519,840	\$586,445	\$645,089
Accessories Revenue	\$20,000	\$240,000	\$312,000	\$384,000	\$456,000	\$528,000
<b>Total Retail Revenue</b>	<b>\$421,000</b>	<b>\$5,052,000</b>	<b>\$6,254,820</b>	<b>\$7,332,528</b>	<b>\$8,294,808</b>	<b>\$9,150,689</b>
<u>Cost of Goods Sold</u>						
Flower COGS	(\$77,162)	(\$925,942)	(\$1,203,725)	(\$1,481,508)	(\$1,759,290)	(\$2,037,073)
Concentrate COGS	(\$60,000)	(\$720,000)	(\$936,000)	(\$1,152,000)	(\$1,368,000)	(\$1,584,000)
100mg Infusion COGS	(\$45,000)	(\$540,000)	(\$702,000)	(\$864,000)	(\$1,026,000)	(\$1,188,000)
10mg Infusion COGS	(\$15,000)	(\$180,000)	(\$234,000)	(\$288,000)	(\$342,000)	(\$396,000)
Accessories COGS	(\$10,000)	(\$120,000)	(\$156,000)	(\$192,000)	(\$228,000)	(\$264,000)
<b>Total Cost of Goods Sold</b>	<b>(\$207,162)</b>	<b>(\$2,485,942)</b>	<b>(\$3,231,725)</b>	<b>(\$3,977,508)</b>	<b>(\$4,723,290)</b>	<b>(\$5,469,073)</b>
<b>Retail Gross Profit</b>	<b>\$213,838</b>	<b>\$2,566,058</b>	<b>\$3,023,095</b>	<b>\$3,355,020</b>	<b>\$3,571,518</b>	<b>\$3,681,616</b>
Taxes on Gross Profit (@ 35%)	(\$74,843)	(\$898,120)	(\$1,058,083)	(\$1,174,257)	(\$1,250,031)	(\$1,288,566)
<b>Gross Profit Less Taxes</b>	<b>\$138,995</b>	<b>\$1,667,938</b>	<b>\$1,965,012</b>	<b>\$2,180,763</b>	<b>\$2,321,487</b>	<b>\$2,393,050</b>
<u>Labor Expenses</u>						
Executive Allocation	\$0	(\$119,866)	(\$112,504)	(\$121,512)	(\$128,146)	(\$133,039)
General Manager	(\$12,500)	(\$50,000)	(\$50,750)	(\$51,511)	(\$52,284)	(\$53,068)
Assistant Manager	(\$10,000)	(\$40,000)	(\$81,200)	(\$82,418)	(\$83,654)	(\$84,909)
<b>Management Total</b>	<b>(\$22,500)</b>	<b>(\$90,000)</b>	<b>(\$131,950)</b>	<b>(\$133,929)</b>	<b>(\$135,938)</b>	<b>(\$137,977)</b>
Supervisor	(\$7,800)	(\$31,200)	(\$63,336)	(\$64,286)	(\$65,250)	(\$66,229)
Security	(\$10,400)	(\$62,400)	(\$63,336)	(\$64,286)	(\$65,250)	(\$66,229)
Sales	(\$20,280)	(\$81,120)	(\$109,782)	(\$111,429)	(\$141,376)	(\$143,496)
Reception	(\$9,100)	(\$46,800)	(\$47,502)	(\$48,215)	(\$48,938)	(\$49,672)
<b>Non-Management Total</b>	<b>(\$47,580)</b>	<b>(\$221,520)</b>	<b>(\$283,956)</b>	<b>(\$288,216)</b>	<b>(\$320,814)</b>	<b>(\$325,626)</b>
<b>Total Labor Expenses</b>	<b>(\$70,080)</b>	<b>(\$431,386)</b>	<b>(\$528,411)</b>	<b>(\$543,657)</b>	<b>(\$584,898)</b>	<b>(\$596,643)</b>
<u>Operating Expenses</u>						
Rent	(\$78,192)	(\$78,192)	(\$78,192)	(\$78,192)	(\$78,192)	(\$78,192)
Advertising Expense	(\$120,000)	(\$120,000)	(\$120,000)	(\$120,000)	(\$120,000)	(\$120,000)
Bank Charges	(\$421)	(\$5,052)	(\$6,255)	(\$7,333)	(\$8,295)	(\$9,151)
Cashier Over & Short	(\$421)	(\$5,052)	(\$6,255)	(\$7,333)	(\$8,295)	(\$9,151)
Contract Labor / Professional Services	(\$4,210)	(\$50,520)	(\$62,548)	(\$73,325)	(\$82,948)	(\$91,507)
Legal & Accounting	(\$8,420)	(\$101,040)	(\$125,096)	(\$146,651)	(\$165,896)	(\$183,014)
Credit Card Processing Fees	(\$10,525)	(\$126,300)	(\$156,371)	(\$183,313)	(\$207,370)	(\$228,767)
Dues & Subscriptions	(\$421)	(\$5,052)	(\$6,255)	(\$7,333)	(\$8,295)	(\$9,151)
Insurance	(\$2,105)	(\$25,260)	(\$31,274)	(\$36,663)	(\$41,474)	(\$45,753)
Janitorial Services	(\$421)	(\$5,052)	(\$6,255)	(\$7,333)	(\$8,295)	(\$9,151)
Licensing & Permits	(\$1,169)	(\$14,033)	(\$17,375)	(\$20,368)	(\$23,041)	(\$25,419)
Meals & Entertainment	(\$421)	(\$5,052)	(\$6,255)	(\$7,333)	(\$8,295)	(\$9,151)
Office Supplies	(\$1,263)	(\$15,156)	(\$18,764)	(\$21,998)	(\$24,884)	(\$27,452)
Packaging Supplies	(\$2,105)	(\$25,260)	(\$31,274)	(\$36,663)	(\$41,474)	(\$45,753)
Interest	\$0	\$0	\$0	\$0	\$0	\$0
Repairs & Maintenance	(\$737)	(\$8,841)	(\$10,946)	(\$12,832)	(\$14,516)	(\$16,014)
Security	(\$9,356)	(\$112,267)	(\$138,996)	(\$162,945)	(\$184,329)	(\$203,349)
Telephone & Internet	(\$2,105)	(\$25,260)	(\$31,274)	(\$36,663)	(\$41,474)	(\$45,753)
Utilities	(\$1,684)	(\$20,208)	(\$25,019)	(\$29,330)	(\$33,179)	(\$36,603)
Travel Expenses	(\$632)	(\$7,578)	(\$9,382)	(\$10,999)	(\$12,442)	(\$13,726)
Maintenance Allowance @ 5% of Initia	(\$10,816)	(\$10,816)	(\$10,816)	(\$10,816)	(\$10,816)	(\$10,816)
<b>Total Retail Operating Expenses</b>	<b>(\$255,423)</b>	<b>(\$765,991)</b>	<b>(\$898,602)</b>	<b>(\$1,017,419)</b>	<b>(\$1,123,511)</b>	<b>(\$1,217,872)</b>
<b>Retail Net Operating Income</b>	<b>(\$462,833)</b>	<b>\$470,561</b>	<b>\$537,999</b>	<b>\$619,687</b>	<b>\$613,078</b>	<b>\$578,536</b>

<b>Retail Cap Ex Budget</b>	
License Application Fee	\$30,000
Annual License Fee	\$30,000
<b>Total Licensing</b>	<b>\$60,000</b>
<u>Construction</u>	
Construction Cost @ \$35 PSF	\$76,020
Construction Contingency @ 20%	\$15,204
<b>Construction Total</b>	<b>\$91,224</b>
<u>FFE</u>	
Hardware/Electronics - 3 Work Stations (\$600), 2 TVs (\$800), Printer, Money counter, etc.	\$7,500
Point of Sale System / Scales (\$1,800 per)	\$5,400
IT/Phone	\$5,000
Security (Cameras, DVR, Install, Reinforcement)	\$25,000
Signage	\$5,000
Finishes (Sales counters, Displays, etc.)	\$20,000
Office Equipment - Office Chairs, Desk, Work Tables, etc.	\$7,500
Office Supplies	\$3,000
Vault room (15 x 15)	\$25,000
Opening Marketing	\$10,000
Initial packaging	\$2,000
Display / smallwares	\$2,000
Wages for Training	\$7,700
<b>Total Retail FFE</b>	<b>\$125,100</b>
<b>Retail Total Upfront Capital Investment</b>	<b>\$276,324</b>

# RETAIL OPERATIONS PLAN

If approved by the city, we will operate in accordance with this Retail Operations Plan and any associated plans or procedures that may be articulated as conditions of our conditional use permit. All plans are designed to adhere to Santa Rosa City Code (SRCC) Chapter 20-46, California Business and Professions Code §26000, and related city and state rules and regulations.

The Retail Operations Plan serves as rules and protocols for running a compliant dispensary. Management will regularly examine our operations, along with legal counsel, to confirm that we are meeting all of our state and local compliance obligations, as well as conforming to our commitments to the City of Santa Rosa and our neighbors. To the extent the principals and managers of Phenotopia determine that an operational change is warranted, we will ensure all updates to the operations plan are timely and effectively communicated to appropriate city staff and neighborhood partners.

## OPERATIONAL TIMELINE

### START-UP PLAN

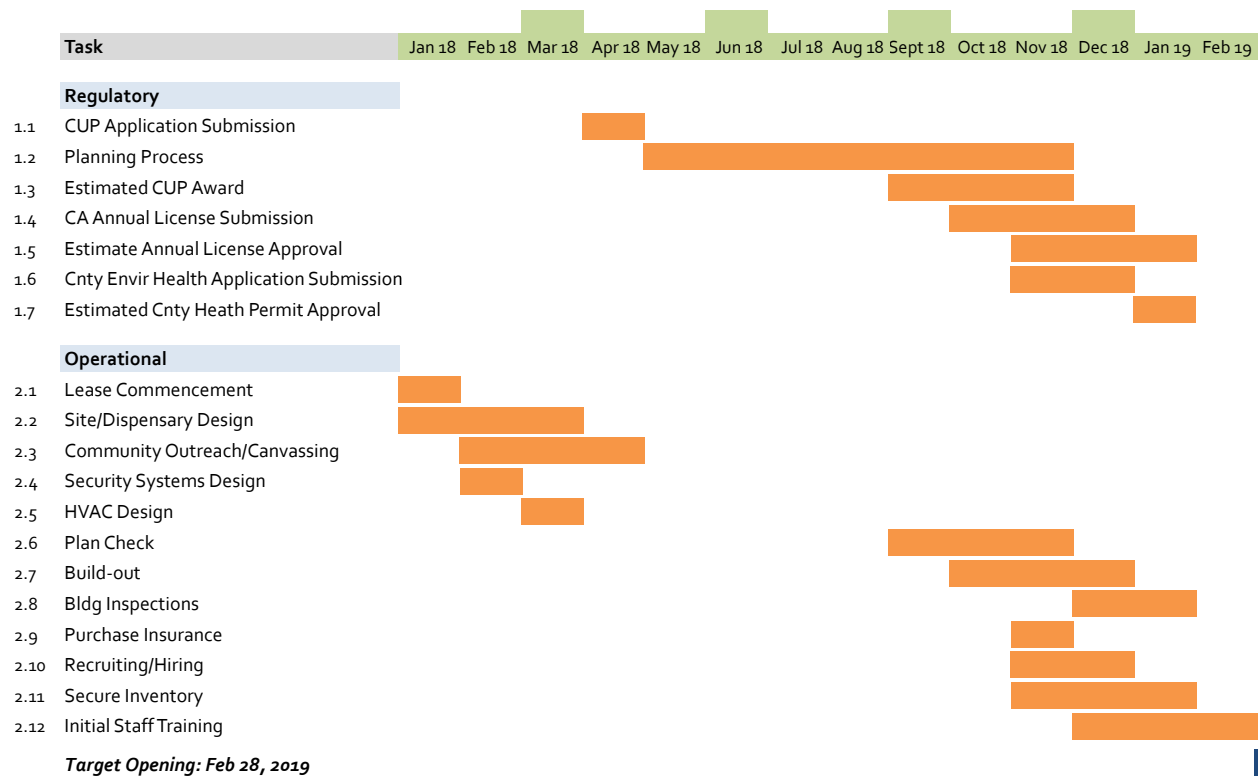

Taking into account the variability of the planning process based on the likelihood of competing dispensaries with the retail concentration buffer, we are targeting a February 28, 2019 opening for the Phenotopia dispensary.

We have already secured essential early third-party vendors, including security company, HVAC engineers, and an interior design firm. Interior construction plans, state license application, and

Sonoma County Environmental Health permit application will all be prepared during the Santa Rosa planning process so each may be submitted immediately to the relevant regulatory agencies should we receive a conditional use permit. Following plan check, we anticipate a period of 4-8 weeks to complete interior build-out and city inspections. We will commence initial recruiting and hiring during that time, as well as begin contracting with licensed distributors for February delivery of initial inventory. Initial staff training will be conducted from first hire up through opening day.

**ORGANIZATIONAL STRUCTURE & PERSONNEL**

**ORGANIZATIONAL CHART**

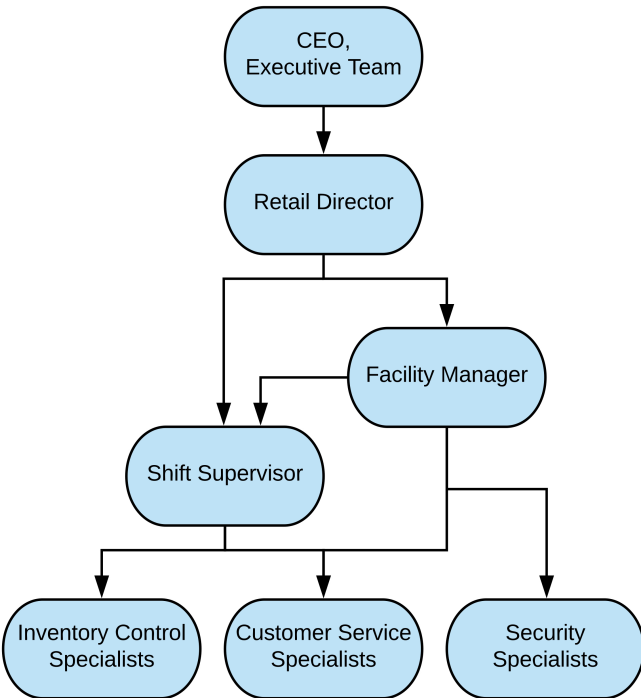

**POSITION DESCRIPTIONS**

**Retail Director**

The Retail Director serves as head of dispensary business operations and reports directly to Phenotopia principals and executive management. The Retail Director’s duties include:

- Management of all business operations related to financial accounting, inventory management, and other essential recordkeeping procedures
- Oversight of site management issues, including building and property integrity, security procedures, and staff and customer safety
- Supervision of human resources functions, including recruitment, hiring, training, performance reviews, scheduling, payroll administration, employee discipline, and related issues

- Development and execution of marketing and merchandising efforts in a tasteful and compliant manner that supports the principles of the Phenotopia brand.
- Ensuring quality of customer experience and acting as primary community liaison for the store
- Regular financial and operational reporting to Phenotopia principals and executive management team

### **Facility Managers & Shift Supervisors**

Reporting directly to the Retail Director, Facility Managers and Supervisors will be responsible for ensuring the operational integrity of retail operations. As the primary “front-of-house” leadership, they hire, manage and supervise all on-duty customer service and security staff and are generally responsible for ensuring an efficient sales floor operation and a safe and satisfying customer experience. Whenever the Retail Director is not on site, the Facility Manager/Supervisor will be primarily responsible for compliance on all essential operational issues, including inventory management, cash handling and transactional recordkeeping, site security and management, and customer or community experience.

### **Inventory Control Specialists**

Inventory Control Specialists will receive shipments of products from distributors, verify and enter stock into the CDFA Track and Trace System, and facilitate the movement of limited stock quantities from the secured storage vault to the retail floor throughout the day. The Inventory Control Specialists will also work with the Retail Manager and Security Specialists to execute regular inventory audits, report any inventory issues or discrepancies to the proper leadership role, monitor viability of stock via printed expiration dates, and dispose of any damaged or unusable product in a compliant manner.

### **Customer Service Specialists**

Customer Service Specialists will serve as the primary customer care staff member. Sales specialists will greet customers on the sales floor, engage customers in conversations about their cannabis knowledge, interests and needs, and answer questions about the store’s products. Customer Service Specialists will be knowledgeable about each of the store’s product offerings and specifically trained to answer questions and provide information on safe and effective dosage and methods of use for each product. Customer Service Specialists will also staff the store’s counter registers, execute sales transactions, enter critical transactional information into our POS software platform, and ensure all products leave the store in compliant exit packaging.

### **Security Specialists**

Security Specialists will be responsible for practical implementation of the Security Plan and adherence to California and Santa Rosa security rules and regulations. They will be trained in peaceful de-escalation methods and presenting themselves as friendly, non-intimidating support for our customers. Among the Security Specialists responsibilities are:

- Physical monitoring and patrol of the property, including maintaining a consistent presence in the dispensary reception area

- Assess, engage with, and de-escalate any safety issues that arise through the normal course of operations
- Liaising with third-party security company (Crime Alert) on issues involving surveillance and alarm systems
- Checking all visitor identification upon entry into the store
- Providing recommendations to management for updates to the security procedures
- Evaluating all reportable security incidents and generating detailed reports for senior management, regulatory authorities, and law enforcement
- Maintain continuous loss prevention protocol and protect against illegal redistribution
- Assisting with staff training on security procedures

## HUMAN RESOURCES POLICIES

### RECRUITMENT

For high-level managers, Phenotopia will utilize 421 Group’s staffing and executive search services to identify qualified candidates and subject candidates to vetting by industry experts. For staff level hiring, Phenotopia will advertise openings on Craigslist, Indeed, and other online job posting platforms that have a record of success for other cannabis retail outlets. 421 Group will assist the Retail Director and Facility Manager in evaluating all candidates, including assessing application materials and conducting a series of phone screens and live interviews to assess skill match and culture fit.

In keeping with both the letter and the spirit of California’s “Ban the Box” law, Phenotopia will not request criminal histories from, nor conduct criminal background checks on, any candidates prior to issuing a conditional offer of employment. Once such an offer is made, we will request voluntary disclosure of criminal history and may conduct criminal background checks to determine if convictions for violent, predatory, or honesty crimes indicate reconsideration of the offer. Phenotopia will not conduct credit checks, and any background checks will be conducted in strict compliance with local, state, and federal notice, disclosure and appeal requirements.

As we endeavor to be a neighborhood business, Phenotopia will direct recruiting efforts toward the Roseland community to the maximum extent possible. We endeavor to hire customer-facing personnel with language skills that allow us to serve the highly-diverse neighborhood and, with the assistance of professional staffing consultants, will make the elimination of bias a priority in developing all language for recruiting announcements, job descriptions, employment applications, and other human resource materials.

### EMPLOYEE WAGES & BENEFITS

Phenotopia will offer above a living wage for all its employees, which is currently estimated at approximately \$15 per hour for entry level employees in Sonoma County. Therefore, we anticipate hiring entry level Customer Service Specialists, Inventory Clerks, and Security Specialists above this rate, with upward adjustments based on experience and market competition for the best candidates.

Managerial staff will receive a hybrid compensation package. In addition to a competitive base salary, the Retail Director and Retail Manager will receive incentive bonuses based on dispensary performance in the form of a percentage of annual profit.

Phenotopia will provide all employees health insurance through Kaiser Permanente’s Silver plans or their equivalent at 70% employer contribution, as well as dental insurance at 50% contribution, vision insurance, and a basic life insurance policy. As the federal conflict experienced in our financial institutions finds resolution, we look forward to offering 401k or similar retirement options.

---

### PERSONNEL RECORDS

Phenotopia will maintain detailed personnel records for anyone currently or previously employed by the dispensary. Personnel records, which shall at a minimum include application materials, training records, wage and benefit documents, and disciplinary records, will be maintained for a minimum of seven years in accordance with 16 CCR §6037(a). Per SRCC §20-46.080)(F)(1), an up-to-date register of all employees will be made available to city officials upon request.

---

### EMPLOYEE CREDENTIALS

Phenotopia will issue all employees a laminated employee badge that meets the requirements of 16 CCR §5043. Phenotopia employee badges will identify the company name, state cannabis license numbers, employee name and position, and a unique employee identification number, along with a 1 x 1.5-inch color headshot of the employee. Employees will be required to display their employee badges whenever they are on the dispensary premises in an official capacity.

---

### TRAINING

Phenotopia management, along with our team of external advisors, possesses a wealth of expertise in the various subject areas essential to running a safe, efficient, and compliant dispensary operation in California. While some dispensaries tailor training programs according to the particular job description of the employee, Phenotopia will mandate that all employees—whether management or entry level—complete each training module within 4 months of hire date. Mandatory training modules will include:

- Legal & Regulatory Basics of Commercial Cannabis
- Cannabis Science & Medical Use
- Confidentiality and Customer/Patient Privacy
- Retail Operations:
  - Safety and Security Plans and Procedures
  - Reception and Customer/Patient Intake
  - Product Offerings and Safe Use
  - Customer/Patient Assistance and Sales
  - Site Management & Community Relations
- Diversion Prevention, Inventory Management, and the Track & Trace System
- Emergency Action Plan & Disaster Preparedness

---

## DRUG & ALCOHOL-FREE WORKPLACE

Phenotopia is committed to providing a safe and welcoming environment for its employees and customers. To uphold that commitment, Phenotopia will enforce a Drug and Alcohol-free Workplace Policy strictly prohibiting the following:

- The use of alcohol or controlled substances inside or within the immediate vicinity of the dispensary premises by any person
- The distribution or transfer of any controlled substances inside or within the immediate vicinity of the dispensary by any person, except authorized sales of cannabis products through Phenotopia’s official sales processes

Employees violating the Drug and Alcohol-free Workplace Policy will be subject to discipline, including potential termination of employment. Customers or other visitors will be advised cordially on the policy and, if necessary, requested to leave. Customers who violate this aspect of Phenotopia policy after initial counseling will be permanently banned from the facility. If appropriate, law enforcement will be contacted.

## INTERNAL MEETINGS & REPORTING

Phenotopia will maintain a fixed organizational meeting and reporting schedule to ensure management remains current on all essential operational issues and staff is consistently apprised of and trained on up-to-date policies and procedures.

All-staff meetings will occur on a bi-monthly basis. Senior staff will conduct weekly manager meetings to discuss key operational issues. At the beginning of each shift—once upon opening and once mid-day—all dispensary staff will attend a 5-minute shift “check-in” meeting to exchange information relevant to the day or shift.

The Retail Director will compile weekly and monthly retail performance reports assessing revenue, customers, and individual product performance. Safety and facility inspection reports will be completed on a weekly basis, with unique security incidents or concerns requiring a report to the executive management team within 24 hours of identification. Cash deposits will be counted and verified by a Manager within a day of receipt. Inventory audits will be conducted within each department on a daily basis, resulting in a full cycle count occurring at least once per week, and managers will audit inventory counts weekly for errors or outlier data points. Full loss investigations will be due to the executive management team within three business days of discovery of the information causing the investigation. For further information, see Security Plan, “Inventory Control”.

## SALES FLOOR OPERATIONS

---

### SECURITY/RECEPTION

A dedicated security kiosk will occupy the front entryway of the dispensary. Upon entry, guests will be greeted by a Security Specialist who will verify the guest’s age through valid photo identification in accordance with 16 CCR §5402. Security Specialists also serve a concierge role for all incoming guests—



answering questions, connecting customers with appropriate service staff, and generally supporting positive interactions with guests and members of the community. Upon determining whether a guest is a medical or adult use customer, the Reception Specialist will direct the customer to the appropriate part of the sales floor and connect him/her with sales staff.

---

## SALES FLOOR & CHECKOUT

Phenotopia will feature an open-floor layout with a peninsula-style checkout counter that projects into the sales floor from the back wall. Small quantities of each product offering will be exhibited in glass display cases lining the outer walls of the sales floor, with medical and adult use products displayed in separate sections of the store. Cannabis flower samples will be displayed in containers that facilitate smell and visual inspection, and upon expiration will be disposed of in accordance with Bureau of Cannabis Control regulations.

Phenotopia Customer Service Specialists will be an active presence throughout the sales floor—offering support and information to browsing customers. Customer Service Specialists will carry digital tablets enabling them to provide greater detail on individual product offerings, sending order requests to the back of the house for fulfillment and packaging, and transferring information to the point of sale (POS) system.

When a customer is ready to make a purchase, sales specialists on the floor will direct the customer to the appropriate counter staff, where separate medical and adult use POS systems will occupy corresponding locations along the checkout counter. When necessary during particularly busy periods, a service line stanchion will be utilized to control customer flow at the counter. Upon completing the transaction, all cannabis products will be placed into opaque and, if applicable, child-resistant exit packaging before departing the premises in accordance with 16 CCR §5029 and §5413.

## DELIVERY; ONSITE CONSUMPTION; SPECIAL EVENTS

At present, Phenotopia does not plan to operate a delivery service, permit onsite consumption, or organize special events. Following the first year of operation, we will reexamine the delivery market and assess whether the addition of delivery services, subject required permit modification, may be appropriate in the context of our business.

## PRODUCT SAFETY

Phenotopia will only purchase cannabis goods where the contents have been verified by a licensed testing laboratory and all products kept on dispensary premises will be packaged and stored in a manner designed to preserve freshness and safety. With regard to edible products, Phenotopia will obtain a Sonoma County Health Permit before obtaining or selling any food products and strictly adhere to the requirements of that permit. SRCC § 20-46.080(E).

## INVENTORY CONTROL & DIVERSION PREVENTION

Phenotopia will implement policies and procedures to ensure that all cannabis, cannabis products, and associated waste are stored and managed at all times in a secure manner so as to prevent diversion,

theft, loss, hazards, or nuisance in accordance with SRCC §20-46.050(G)3. We recognize that cannabis retailers can contribute significantly to the public health and safety and we are committed to making sure that our contribution is a positive one.

Access to our facility will be strictly controlled at all times in accordance with the procedures described above under the Security Plan. We will purchase cannabis only from state-licensed distributors, we will securely store those products for the entire period they are within Phenotopia’s control, and we will record each step of the custodial process into the CDFA Track and Trace System. All storage areas, display cases, and point-of-sale (POS) terminals will be under constant video surveillance, which offers an additional layer of inventory oversight.

Staff will be trained to comply with state regulations concerning the possible diversion of cannabis from the legal market. Such protocols include age verification, adhering to daily purchase limits, and entering all transactions into the Track and Trace System.

---

### INVENTORY STORAGE & ACCESS

Physically securing cannabis goods within the facility is an essential element to a strict inventory control environment. For details, see “Locks and Access Control” and “Secure Access and Storage” in the Security Plan.

---

### RECORDKEEPING AND REPORTING

Phenotopia will strictly adhere to the state’s track and trace program and require all employees to undergo training on the Track and Trace system at the outset of their employment. SRCC §20-46.050(C); 16 CCR §5048. The TREEZ point of sale and enterprise management platform will facilitate integration of relevant dispensary records with the Track and Trace System. Customer information and sales records will likewise be maintained in TREEZ, in accordance with applicable law. SRCC § 20-46.080(F)2.

As required by 16 CCR §5049, Phenotopia staff will record the following activities in the Track and Trace System within 24 hours:

- Sale of cannabis goods
- Receipt of cannabis goods
- Return of cannabis goods
- Destruction and disposal of cannabis goods
- Any other activity as required pursuant to 16 CCR 5000 et. seq., or by any other licensing authority

For each activity entry in the Track and Trace System, the following details will be recorded:

- Name and type of the cannabis goods
- Unique identifier of the cannabis goods
- Amount of the cannabis goods, by weight or count
- Date and time of the activity or transaction

- Name and license number of other licensees involved in the activity or transaction

Staff will be trained on how to operate in the event of a service disruption or loss of access to the Track and Trace system. In that case, staff will have access to forms for manually recording necessary information for the duration of the service outage, which will retroactively be entered into the Track and Trace System once access is restored. 16 CCR §5050.

Beyond Track and Trace System requirements, staff will maintain inventory records on site detailing the following:

- Description of each item
- Accurate measurement of the quantity of the item
- Date and time the item was received
- The sell-by or expiration date, if any
- Name and license number of the licensee that produced the item
- Name and license number of the distributor that provided the item to us
- Price paid for the item, including taxes, delivery costs, and other charges

Managers conduct regular inventory audits to ensure that our physical inventory counts match the amounts entered into the track and trace system. State regulations require such audits to occur at least once every 14 days. However, Phenotopia managers will audit all departments inventory counts on a weekly basis. Per 16 CCR §5034, a significant discrepancy in inventory means a difference between recorded and actual inventory of at \$5,000 or 2 percent of the average monthly sales of the dispensary, whichever is less. Reportable discrepancies will be notified to the Bureau of Cannabis Control, as required by 16 CCR §5036, as well as the Santa Rosa Police Department.

In addition to inventory records, staff will maintain individual retail transaction information in accordance with 16 CCR §5425, including:

- Name and employee number processing employee
- Name and customer number of purchaser (for medical customers)
- Date and time of the transaction
- List of all goods purchased and their quantity
- Total amount paid

Phenotopia staff will maintain strict control over what we sell, to whom, and in what amounts. In no case will we sell more than the legal maximum amounts to a single adult-use cannabis customer in a single day: 28.5 grams of flower, 8 grams of concentrate, or 6 immature plants. For medical cannabis customers, we may sell up to 8 ounces of cannabis or 12 immature plants, per 16 CCR §5409. These purchase limits represent a ceiling, not a floor. If transaction records indicate suspicious behavior, such as a customer who regularly purchases the daily maximum or who attempts to purchase more than the daily maximum, management will examine the need for additional purchase limits.

In accordance with state recordkeeping requirements, the following records will be maintained for at least seven years:

- Financial records, including bank statements, sales invoices, receipts, and tax records
- Personnel and training records
- Contracts with other cannabis licensees
- Permits, licenses, and other local authorizations
- Security records
- Records relating to the destruction of cannabis goods
- Documentation for data or information entered into the Track and Trace System
- All other documents associated with the dispensary business

Records will be replicable in both hard copy and electronic form and will be available upon authorized request for examination by the Bureau or local law enforcement.

## SITE MANAGEMENT & NUISANCE PREVENTION

Phenotopia’s management is aware of the extent to which some cannabis operations may affect neighbors who live and/or work in the surrounding area.

We recognize that a failure to maintain a safe and secure environment would threaten not only our business model and brand integrity, but also the health and wellbeing of people and businesses in the surrounding community. We will make every effort to prevent nuisance behaviors such as diversion of cannabis, public intoxication, smoking in public, harassing a passerby, littering, obstructing streets or sidewalks, engaging in illegal drug activity, or generally disturbing the peace, as called for by SRCC §20-46.100.

Our Security Specialists will regularly monitor our facility, our neighbors’ facilities, our shared parking lots, and adjoining properties that are open to the public. Among other negative impacts, Security Specialists will be charged with identifying and recording notable incidents of graffiti, litter, illegal dumping, and loitering that occur at Dutton Plaza or adjacent properties. Staff will be trained to take reasonable steps to prevent nuisance behaviors in these areas, including by directly engaging with responsible parties (unless personal safety would be threatened in making the request), initiating peaceful de-escalation techniques, and/or by calling the police in a timely manner.

To incentivize diligent staff action in responding to such incidents, nuisance response and neighbor relations will be explicit job performance metrics for all Phenotopia management and staff. Prior to conducting annual performance reviews, supervisors will solicit input from neighboring businesses about nuisance incidents and staff’s timeliness in responding to notifications or complaints. Neighbor input will be incorporated into each staff member’s individual review, with the potential to influence incentive compensation and/or continued employment.

In addition to directly responding to nuisances, we believe proactive community engagement and coordination amongst neighbors are essential to preventing potential negative impacts. In the course of developing our project, we have connected with all of our closest commercial neighbors to introduce our plans and establish a line of communication that we hope will be valuable in preventing and mitigating nuisance incidents in the future. For more information on our neighborhood outreach efforts, see “Neighborhood Enhancement & Community Relations”.

# SECURITY PLAN

## INTRODUCTION

This Security Plan is designed for our proposed cannabis retail facility at Dutton Plaza, 443 Dutton Avenue, Suite 11, Santa Rosa. Through assistance from our own cannabis industry experts and third-party professional security consultants, Phenotopia is establishing security practices involving physical and operational standards used by successful cannabis businesses throughout California. A combination of security technologies and strict operational procedures are intended to prevent crime and diversion, deter nuisance activity, and protect both Phenotopia staff and residents of the surrounding area.

This Security Plan is designed to comply with all applicable local and state requirements, including Chapter 20-46 of the Santa Rosa Municipal Code and Title 16, Division 42 of the California Code of Regulations.

## PROFESSIONAL SECURITY SERVICES

Phenotopia has hired Crime Alert Security to assist in security planning and ongoing monitoring and surveillance of the dispensary facility at 443 Dutton Avenue. Crime Alert—CA license number ACO7496—has extensive experience working with cannabis businesses throughout Northern California to advise on best practices and implement security systems to protect their operations. Crime Alert's dedicated inclusion to this Security Plan is included as Attachment A to this application.

## PHYSICAL SECURITY SETTING

The entire parcel containing Dutton Plaza is 2.87 acres and includes 18 single-story units comprising 26,288 square feet. The Dutton Plaza parking lot has entrances on both Dutton Avenue and Sebastopol Road, with 136 customer spaces in the front parking lot serving the 18 strip center retail stores. Employee parking is located along the rear of the building. In addition, there is a Jack in the Box restaurant occupying a half-acre parcel in the corner of the shared parking lot (425 Sebastopol Road). The restaurant operates a 24/7 drive-through window.

The dispensary will occupy a 2,172 sq. ft., in-line unit in the retail strip. Adjacent units, which share side walls with the dispensary, are occupied by DolEx money services and Joyeria Torres, both retail businesses holding customary retail hours. The unit is fronted by large retail windows and a double-door front entrance. A single non-public door is located at the rear of the building. There is no dedicated vehicle entrance (e.g. loading bay) or roof access to the unit.

Our store will employ between 10 and 15 staff and serve an estimated 100 to 200 customers per day. Hours of operation will be 9:00 am to 9:00 pm, 7 days per week. The planned sales floor would occupy the front 1,100 sq. ft. of the retail unit, with display cases around the outside of the room and a

peninsular service/sale counter extending from the rear wall into the middle of the room. Inventory will be stored in a fully sealed and secure room at the rear of the unit, and a reception/security desk will occupy the main public entryway. Exterior lighting will also comply with property owner-enforced rules as well as state and local regulatory requirements and will be appropriate for nighttime visibility by police and security staff.

## LOCKS AND ACCESS CONTROL

In accordance with SRCC §20-46.050(G)5 and 16 CCR 5046, all points of entry and exit will be equipped with Building Code compliant commercial-grade door and/or window locks. Phenotopia personnel will be issued keys granting access only to those areas required for the completion of their particular job duties, and each key issued will be recorded in the dispensary’s secured records.

Only managers and certain authorized employees will be permitted to enter the limited access areas—inventory control and safe rooms—in the rear of the facility. 16 CCR 5401(a). Other individuals with a bona fide business reason for entering a limited access area (such as third-party contractors or unauthorized employees) will be escorted by a manager or authorized employee at all times while in such areas. 16 CCR 5401(c). A log will be maintained to document all non-employees who enter a limited-access area with authorization. 16 CCR 5401(e).

All employees will be required to wear a laminated identification credential badge at all times while on duty. Per the requirement of 16 CCR 5043, each identification badge will include following:

- Company Name
- State Cannabis License Numbers
- Employee Name
- Employee Position
- Unique Employee Identification Number, and
- Color Photograph Showing the Full Front of Employee

## SURVEILLANCE CAMERAS

A comprehensive video surveillance system is a central component of Phenotopia’s Security Plan. With assistance from Crime Alert, we will install and maintain a network of high resolution security cameras that monitor our business from the inside and out. Surveillance cameras will cover all areas where cannabis is received, inventoried, stored, packaged, transferred, or sold, in addition to full coverage of the sales floor, sales counter, and all external entry points. The cameras will record 24 hours per day and will capture high quality images in any lighting condition so as to allow for clear and certain identification of all individuals in accordance with SRCC §20-46.050(G)1.

The video surveillance system will also comply with all state regulatory requirements. Recorded images will clearly and accurately display the time and date in accordance with 16 CCR 5044(k). The system will be equipped with a failure notification system that provides prompt notice to our management of any prolonged interruption and/or failure of the system. 16 CCR 5044(l). All video recordings will be maintained for a period of not less than 90 days. 16 CCR 5044(i).

Additional camera specifications, including a map illustrating coverage, can be found in Attachment A: Crime Alert Dispensary Facility Security Plan.

Upon suspicion that a security-related incident may have occurred, management will review the surveillance footage as a part of their incident investigation. Such footage, as well as the results of any such investigation, will be available for inspection by law enforcement in compliance with state and local law.

## ALARM SYSTEM

Phenotopia will be protected by an alarm system installed, maintained, and monitored by Crime Alert in compliance with state and local requirements. Before installation, Phenotopia will apply for an alarm system permit from the Santa Rosa Police Department in accordance with SRCC §6-68.130.

The alarm system will be monitored 24 hours a day, 7 days a week by Crime Alert’s UL-listed central station. When the system is armed, infra-red motion detectors and door contacts will automatically trigger the alarm, per SRCC §20-46.050(G)2. The alarm may also be triggered by manually by “Holdup Buttons,” which will be placed at strategic locations through the dispensary. Each Phenotopia employee will receive individualized alarm codes and all arming or disarming actions will be recorded and digitally stored for a period of 90 days. See Attachment A: Crime Alert Dispensary Facility Security Plan in for further alarm system details.

## SECURITY PERSONNEL

Phenotopia will hire and specially train several security professionals to serve as full-time, in-house Security Specialists. A Security Specialist will be on duty at all hours that the dispensary is open to the public and will regularly staff the reception desk in the front entranceway of the store. All Phenotopia Security Specialists will be registered or licensed, as required, with Chapters 11.4 or 11.5 of Division 3 of the Business and Professions Code.

## TRANSPORTATION

Because a supply chain is only as strong as its weakest link, we will insist on partnering with trusted, licensed distribution and transportation partners who value security as much as we do. All

transportation and delivery of cannabis, cannabis products, and cash will be handled by licensed professionals in compliant vehicles. SRCC §20-46.050(G)4.

Shipments of inventory will occur during or immediately preceding regular business hours, and in no case will we accept a shipment outside the hours of 6:00 a.m. to 9:00 p.m. All shipments will be received through the dispensary’s rear entrance, which is not available for public use and will be covered by two dedicated surveillance cameras. 16 CCR §5422. Shipment timing will vary from one day to the next in order to disrupt any attempt to establish reliable schedules by potential robbers. Upon receiving a shipment, an authorized employee will review the order and ensure that the goods received are as described on the shipping manifest. 16 CCR §5049.

**SECURE STORAGE & WASTE DISPOSAL**

Phenotopia will implement policies and procedures to ensure that all cannabis, cannabis products, and associated waste are stored at all times in a secure manner so as to prevent diversion, theft, loss, hazards, or nuisance in accordance with SRCC §20-46.050(G)3. We recognize that cannabis retailers can contribute significantly to the public health and safety, and we are committed to making sure that our contribution is a positive one.

Access to our facility will be strictly controlled at all times in accordance with the procedures described above under “Locks and Access Control.” We will purchase cannabis only from state-licensed distributors, we will securely store those products for the entire period they are with Phenotopia control, and we will record each step of the custodial process into the CDFA Track and Trace System. All storage areas, display cases, and point-of-sale (POS) terminals will be under constant video surveillance, which offers an additional layer of inventory oversight.

Staff will be trained to comply with state regulations concerning the possible diversion of cannabis from the legal market. Such protocols include age verification, adhering to daily purchase limits, and entering all transactions into the Track and Trace System.

---

**SECURE ACCESS AND STORAGE**

Physically securing the facility is a top security priority. Our professional Security Specialists will be on-site during all operating hours to prevent unauthorized persons from entering the premises or limited-access areas within the premises. SRCC § 20-46.080(F)3. All doors inside the facility will be equipped with commercial grade locks and will be under constant video surveillance. Limited access areas will be clearly marked with signs. SRCC § 20-46.080(F)5.

All cannabis and cannabis products (except for small amounts used for display purposes or for immediate sale) will be stored in a dedicated, locked secure storage room located near the back of the facility. SRCC § 20-46.080(F)6. Only managers and other specifically authorized employees will have access to the secure storage room.

We will strictly comply with state regulatory requirements regarding the display of cannabis goods. All containers used for display purposes will be kept in a secure area accessible only to employees. In the



event that a customer requests to inspect a particular product, an employee will remain with that customer throughout the inspection. 16 CCR 5405. Moreover, the entire sales floor, including display cases and POS terminals, will be under constant video surveillance. Signage will be posted to remind customers of the presence of security cameras.

---

## WASTE DISPOSAL

Secure waste disposal will be treated as essential as any other element of Phenotopia operational security.

All staff will receive training on the proper methods for disposal of cannabis products and cannabis waste in accordance with 16 CCR §5054-55. Prior to disposal, cannabis goods shall be removed from any packaging and rendered unrecognizable and unusable. For maximum security, the resulting cannabis waste will be stored in secured waste containers inside the dispensary facility until the scheduled trash pickup day, at which point the cannabis waste will be placed inside the locked dumpster outside of the facility. We will take great care to ensure that all cannabis, cannabis products, and waste are stored and secured in a manner that prevents diversion, theft, loss, hazards and nuisance in accordance with SRCC §20-46.050(G)3.

## EMERGENCY ACCESS

In accordance with the California Fire Code and Santa Rosa Fire Department standards, our premises will be equipped with a secure lockbox in order to provide access to authorized emergency services. SRCC §20-46.050(G)6.

# ODOR, LIGHT, AND NOISE CONTROL

## ODOR CONTROL

Phenotopia understands that odor management is a matter of neighborhood responsibility. Therefore, both our HVAC systems and our operational procedures have been designed to prevent the detection of any cannabis or cannabis-related odor from any area outside the dispensary unit, including and especially in adjoining units, on adjacent properties, or from public rights-of-way, as required by Santa Rosa City Code.

---

## HVAC SYSTEMS

Our HVAC systems have been designed by licensed engineers from AICE with the specialized needs of a cannabis facility in mind. AICE has outlined a multi-layered approach to ensuring a no-impact operation at our dispensary that includes the following:

- Negative Pressurization
- Carbon Filtration
- Gel Dispersion Odor Neutralization
- Commercial-grade Exhaust Systems
- Heat Recovery Ventilation

For technical specifications on our HVAC equipment and detailed information on their application to our dispensary facility, see Attachment B: AICE Odor Control Plan.

---

## TRANSPORTATION & PACKAGING PROCEDURES

All cannabis inventory our dispensary receives from licensed distributors will be ready for final sale, meaning it will be pre-packaged in sealed, tamper-evident, and child-resistant packaging that complies with California Business & Professions Code §26120. As such, inventory shipments that are unloaded in the rear of our building will not expose any cannabis or produce any odors. We will discontinue relationships with distributors that do not uphold our strict approach to compliant pre-packaging and responsible delivery practices.

No packaging of cannabis will occur on the dispensary premises. Once inside the dispensary, all cannabis will be organized and stored in climate-controlled rooms subject to the specially designed HVAC systems described above. Within our secured inventory control room, minor amounts of raw cannabis may be removed from its packaging for display in our sales floor display cases. Before any cannabis leaves our retail premises, it will be placed in exit packaging required by State law. These exit packages are opaque, child-safe, and fully sealable.

## LIGHTING PLAN

Because the dispensary will occupy a single unit in the existing 18-unit retail strip known as Dutton Plaza, external lighting on the property already exists in compliance with the Santa Rosa Building Code.

Should we require the addition of any additional external lighting—e.g., to illuminate areas of the premises covered by surveillance cameras—we will utilize a licensed local contractor to ensure compliance with both the Santa Rosa Building Code and the Outdoor Light provisions of the Zoning Code (SRCC §20-30.080). Any such lighting will be stationary, fully shielded, and directed away from adjacent properties and public rights of way, as required in Section 20-46050(I). Cutoffs will be used to allow law enforcement to adequately view the facility at night, and light shields will be selected to be of a color and style that is consistent with best practices and cohesive with the building design. Our lights will be of an intensity compatible with the neighborhood, and will use low-wattage, environmentally-friendly and programmable, dimmable LED bulbs.

## NOISE CONTROL

As part of our commitment to community relations, we will minimize the noise impact of our facility, our retail operations and of our dispensary customers.

---

## FACILITY & HVAC SYSTEMS

Our facility will not produce sound outside of ordinary levels in any public areas. Our HVAC engineers have selected light commercial equipment that produces noise levels customary in light commercial/retail environments (see Attachment B: AICE Odor Control Plan) and fully complies with Chapter 17-16 of Santa Rosa City Code. If feasible, we will utilize flexible ductwork and high-velocity registers and grilles, which tend to produce less noise. The entire system will be regularly maintained. Filters will be replaced regularly to avoid dirty ducts, a possible source of extra HVAC noise. Should the level of system noise increase, we will promptly contract a maintenance technician to evaluate the problem and implement a noise-reducing solution.

---

## OPERATIONS

The dispensary will be open to the public only during customary retail hours in line with other businesses in Dutton Plaza: from 9:00 am to 9:00 pm. Opening and closing will occur promptly at the designated times. No loud music or other noise producing activities will be permitted inside the dispensary and we will not permit employees to linger outside of the premise when not working.

All inventory shipments will occur during customary commercial delivery hours, and in no case will we schedule or accept a shipment prior to 6:00 a.m. or later than 10:00 p.m. All shipments will occur in the rear alley of Dutton Plaza and will be received through the dispensary’s rear entrance.

---

## ENFORCING COMPANY POLICIES

In accordance with our nuisance prevention policies, Phenotopia management and customer-facing staff will advise our customers to avoid loud or disruptive activities that may disrupt our neighbors. Since loitering on our premises is not allowed, customers will also be instructed not to sit in the parking lot with engines idling or music playing, or engage in large gatherings or group conversations on the premises. These noise abatement policies will be communicated to customers, vendors, and visitors by our Customer Service Specialists and Security Specialists.

## NEIGHBORHOOD ENHANCEMENT & COMMUNITY RELATIONS

### NEIGHBORHOOD ENHANCEMENT & COMPATIBILITY

Phenotopia is focused on being a positive influence in our Roseland community through quality aesthetic enhancements, community engagement, and environmentally sound operations.

### AESTHETIC AND RETAIL EXPERIENCE

Because of our location in an existing retail plaza, the Phenotopia storefront appearance is partially dictated by the Dutton Plaza facade. The Dutton Plaza facade consists of smooth, brown stucco walls, about 10 feet in height, topped by a beige stucco awning which holds each suite's signage. Each storefront, include Phenotopia's, has floor to ceiling glass windows and glass double entrance doors.

Phenotopia's external improvements will include the installation of high-quality signage—featuring a backlit, art deco style font in muted colors—and the application of a translucent, natural window coating that prevents external sightlines to cannabis products in accordance with state regulations while allowing natural light to fill the sales floor. In addition, Phenotopia will restore and update landscaping in the parking island directly in front of the store through the addition of mulch and drought-tolerant plantings, as permitted by property ownership. Our use of bright, premium materials is intended to create a welcoming ambience for customers and other patrons of the plaza.

*Rendering: Phenotopia Storefront*





With the expertise of a commercial architecture firm, Phenotopia plans a full-scale interior renovation and build-out of the current retail space to create a sleek, design-focused dispensary

Walls and ceilings in the retail space will be pure white, contrasting with polished, “marble” tile flooring. The sales floor will feature counter-to-ceiling product displays lining the external walls with minimalist, natural wood cabinetry, and white metal and composite merchandise shelving. A matching wood sales counter will contain additional, small-scale product displays and point-of-sale registers on varying surface levels, including ADA-accessible counters.

*Rendering: Phenotopia Sales Floor*



Between the dispensary entrance and the sales floor, a light wood and stone colored visual barrier will serve the dual purpose of preventing line of sight into the sales floor area through the front door, while also creating a distinct reception area for arriving customers.

The sales floor aesthetic will continue throughout the non-public areas of the dispensary, along with the practical additions of stainless steel work tables and secure storage doors.

*Rendering: Common Area and Employee Break Room*



In addition to store itself, Phenotopia will actively look for other opportunities to contribute to the physical environment of the surrounding neighborhood, including staff volunteerism and contributing financially to other community groups that aid the beautification of the Roseland community.

---

**ALTERNATIVE TRANSPORT CONNECTIVITY**

Phenotopia will be served by routes 2 and 12 of Santa Rosa City Bus and route 22 of Sonoma County Transit. Stops are located just a few hundred feet from the dispensary entrance at the intersection of Dutton Avenue and Sebastopol Road. The rear of Dutton Plaza abuts the Joe Rodota Trail and has direct bike and pedestrian connections to the plaza’s pedestrian walkway and the dispensary entrance from the Dutton Avenue sidewalk.

To further encourage customer use of bikes, we are discussing the creation of dedicated bike parking with Dutton Plaza ownership. Phenotopia has offered to fund the installation of “wave” or “post-and-ring” style bike racks (see examples below) at either end of the Dutton Plaza retail strip. This will facilitate greater bike access to all 18 stores in the plaza. Adding bike racks will also enhance Dutton Plaza’s alignment with the Sebastopol Road Urban Vision and Corridor Plan, which envisions improved bicycle and pedestrian connections for Sebastopol Road’s commercial activity.

*Photo: Post and Ring Bike Racks*



*Photo: Wave Bike Rack*



## COMMUNITY OUTREACH

With the assistance of local cannabis consultancy 421 Group, Phenotopia began its community outreach efforts by canvassing businesses and residents within 600 feet of our proposed location. Through our canvassing efforts, we were able to evaluate the level of support for our project, engage in open dialogue about the cannabis industry with members of the community and respond to the concerns they raised. The findings of our community outreach efforts are detailed in Attachment C: Canvassing Report. Letters of support from some of our neighbors are included in Attachment D: Letters of Support.

Phenotopia will also make it a priority to attend and participate in community events throughout the year. We believe that it is vital to participate in community events to engage with our neighbors and create ongoing connections to the dispensary.

## COMMUNITY BENEFITS

Creating a positive impact on the community is important to the Phenotopia leadership team, which is specifically interested in supporting educational opportunities and economic mobility for underprivileged youth and their families. Phenotopia is committed to supporting this mission via organizations such as Community Action Partnership of Sonoma (CAPS), which offers services in community organization, health access and awareness, educational opportunities, and financial planning and management, with significant focus on the needs of families in the Roseland and surrounding areas. CAPS offers a unique, modern two-generational approach to financial mobility through their revolutionary program, Via Esperanza. Phenotopia is in communication with CAPS leadership to outline a long-term plan to support this and other programs that directly benefit the surrounding community.

Detailed information on CAPS programs can be found at [www.capsnomas.org/programs](http://www.capsnomas.org/programs).

Our socio-economic contribution to the neighborhood will include the creation of quality job opportunities for our neighbors. This is a practical and proven way to help longtime residents continue to afford to live in neighborhoods like Roseland. As discussed in our Retail Operations Plan, we anticipate hiring at least 10 personnel for the dispensary, and we will focus our recruitment efforts on



the Roseland area, bilingual candidates, and candidates who may have been negatively impacted by the so-called “War on Cannabis.” Moreover, our company-wide hiring footprint will expand further as we develop additional Santa Rosa facilities for Phenotopia’s supply chain operations.

Phenotopia management takes seriously its role as a representative of the Santa Rosa cannabis industry, and management will make a focus on the local community central to the dispensary’s day-to-day operations. No product will leave the dispensary unless in child-resistant packaging that complies with California law, and signs prohibiting smoking, loitering, and long-term parking will be posted in proximity to the dispensary storefront. All management and customer-facing staff will be trained to enforce such rules strictly but courteously to ensure an absence of negative impacts on neighbors.

**COMMUNITY LIAISON**

To further our commitment to nurturing open communication and involvement in our community, we have designated **Lizette De Arkos** as Phenotopia’s Community Liaison.

Lizette grew up in the Roseland community and was a key figure in Phenotopia’s pre-application community canvassing effort. As a result, she has already begun establishing relationships with many business owners and residents in our surrounding area.

Lizette is a community organizer dedicated to accelerating communities through the promotion of socially and environmentally-conscious businesses. As a student at the University of California, Santa Cruz, where she graduated with a Bachelor’s of Art in Community Studies, she created an ethical apparel and decor line. She later attended the University of California, Berkeley, Haas School of Business and worked for startups in the Bay Area, running two e-commerce businesses and graduating from San Francisco’s Startup Leadership Program 2017-18 Cohort.

Her experience in the cannabis industry began when she developed the first market ready HempCrete Kit and brought this innovative building material to the masses. After working in local government for several years, Lizette has rekindled her commitment to the cannabis industry and works diligently to promote its potential for social change, environmental stewardship, and public health.

Lizette has been certified by the County of Sonoma as bilingual in Spanish. She is an active member of Los Cien of Sonoma County and was recognized by La Prensa Sonoma for her commitment to promoting health in the Latino community.

Lizette can be contacted by phone at **(707) 861-8421** or by email at **[lizette@421.group](mailto:lizette@421.group)**.

**ENVIRONMENTAL BENEFITS**

**RENEWABLE ENERGY AND WATER CONSERVATION**

Each retail unit in Dutton Plaza is separately metered, allowing tenants to elect their own electricity provider. Phenotopia will purchase our power supply from Sonoma Clean Power, a publicly run community choice aggregator serving cities throughout Sonoma and Mendocino Counties.



Sonoma Clean Power provides an environmentally-focused alternative to PG&E service by sourcing power from a higher proportion of renewable energy sources. Phenotopia will obtain electric service through Sonoma Clean Power’s “Evergreen” program, which utilizes 100% geothermal energy.

Even though we are the segment of the cannabis industry that uses the least amount of water, we will integrate water conservation practices into our operations. These will include installing aerators on our faucets, utilizing low-flush toilets and monitoring for our facility for water leaks.

---

### SUSTAINABLE PACKAGING

The proliferation of packaging waste is an issue of growing concern for packaging-intensive industries like cannabis. Because of the unique needs of the regulated market—resalable, tamper-evident, and child-resistant packaging—and consumer demand for glitzy branding, most cannabis operators use packaging based on traditional plastics and other hydrocarbon-based materials.

To be a small part of the solution, Phenotopia will endeavor to procure bulk inventory packaging and our child-resistant exit bags from packaging manufacturers that utilize bio-based, renewable materials. Sustainable bulk packaging options are available in the general commercial packaging market. Our sources for compliant exit packaging may include the following California-based, sustainable packaging manufacturers:

- Intellipak’s HISIERRA Exit Bags ([www.hisierrabags.com](http://www.hisierrabags.com))
- Sun Grown Packaging ([www.sungrownpackaging.com](http://www.sungrownpackaging.com))

---

### ALTERNATIVE TRANSPORTATION DISCOUNT PROGRAM

We are examining the introduction of discount programs for a variety of customer segments, including those who use some form of alternative transportation. While one of the benefits of our Dutton Plaza location is the availability of parking, a discount program could incentivize greater use of public transportation or biking to reach the dispensary. If we determine that we can administer such a discount fairly and without an overabundance of abuse, we will advertise the program to customers at the sales counter upon checkout.

## ATTACHMENT B: AICE ODOR CONTROL PLAN

# ODOR CONTROL PLAN

## WOLF HOUSE PROPERTIES

### 443 DUTTON, SANTA ROSA

**PROJECT INFORMATION**

a.	<b>APN</b>	125-111-039-000
b.	<b>Physical Address</b>	443 Dutton, Santa Rosa, CA 95401
c.	<b>Mailing Address</b>	443 Dutton, Santa Rosa, CA 95401
d.	<b>District</b>	5
e.	<b>Neighborhood</b>	Roseland
f.	<b>Zoning</b>	CG (Commercial General)
g.	<b>Facility Type</b>	Approximately 2,050 Square Foot Concrete Tilt Up
h.	<b>Permit Type</b>	Cannabis Retail
i.	<b>Canopy</b>	N/A – No cultivation
j.	<b>Business Entity Name</b>	Wolf House Properties
k.	<b>Facility Hours of Operation</b>	9:00 AM TO 9:00 PM
l.	<b>Emergency Contact Information</b>	Project Manager: Johnny Nolan/ (415) 341-3527

## 1 INTRODUCTION

The locations of possible odor emitting activities include the secured storage room, rest rooms, and sales floor.

The primary method to combat unwanted smells leaving a cannabis retail facility is through negative air pressure. With negative air pressure we can control the flow of air movement in our dispensary facility. All air entering the facility will pass through a MERV 14 filter system and all air leaving the facility will pass through a MERV 13 and carbon filter system.

From the odor control plan, attached, it can be seen that most areas of the facility are under negative pressure (crosshatched). The main retail space is under negative pressure so that door opening creates an inward air flow.

## 2 PRESSURIZATION

In a negative air pressure room, the air pressure in the room is lower than the pressure outside the room. Generally this is achieved by extracting and filtering air out of the room. In most situations, air enters through filters near the floor and then is sucked out through filters from the room at ceiling level.

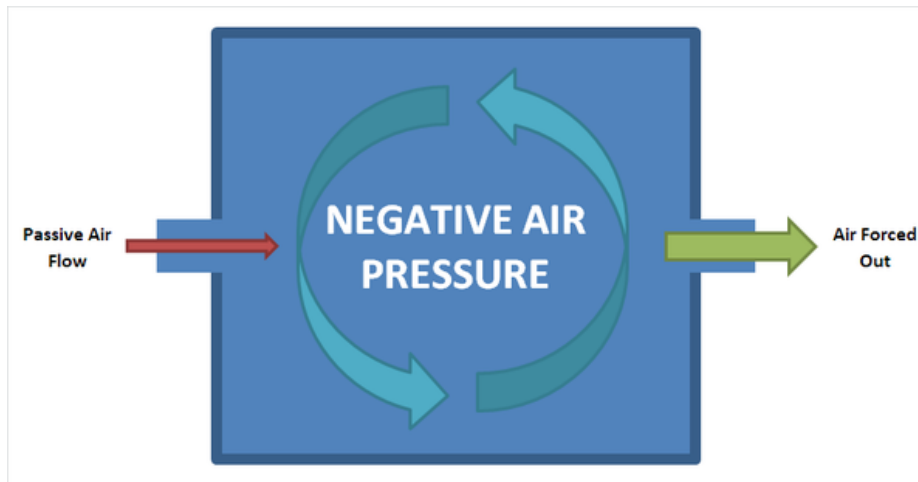

To establish negative pressure in a room that has a normally functioning ventilation system, the room supply and exhaust air flows are first balanced to achieve an exhaust flow of either 10% or 50 cubic feet per minute (cfm) greater than the supply (whichever is greatest).

Negative air pressure rooms are also used in industries that manufacture pharmaceutical products, do biochemical testing, and also in hospitals to quarantine contagious patients. Any air that flows out of the room has to first pass through a carbon filter, ensuring that no odor can escape.

See pressure control plan – Attachment 1.

### 3 CARBON FILTRATION

#### Air Box 2 Stealth Edition 800 CFM 6" Flanges

##### US\$ 365.95 Technical Specifications

The heavy-duty Air Box 2 will successfully eliminates odors for up to 18 months

Carbon filter should be changed often; please replace filters every 12 month (**all of them**) for better results

- Easy to install, easy to use, easy to maintain
- Adaptable to any duct/filtering system
- Replaceable high-flow carbon filters
- 100% premium virgin coconut charcoal
- 100% air tight, continuous worry-free operation
- 100% of the filter surface area is used
- For commercial or residential applications
- Made in the USA



○

Carbon filters eliminate the odor of cannabis.

## 4 ONA GEL DISPERSION SYSTEM

In addition to the primary odor control method above, we employ a secondary odor control system called Ona. Ona odor neutralizing products consist of a complex formulation representing a variety of chemical compounds offering different functionalities, both structural and chemical. The technology behind Ona was initiated over 25 years ago.

The scientist who invented Ona became fascinated when he observed that terpenes, when diffused into the environment, reduce odors and unwanted emissions. Inspired by this finding, future evidence showed that the odors were not just masked but permanently removed. The result was a set of specialized formulations that neutralized a wide spectrum of organic and inorganic odors - effectively, efficiently and permanently. Ona formulations have been scientifically engineered to be environmentally safe.

Ona is manufactured under strict quality controls to ensure a safe and non-toxic product. The components used to make Ona are generally recognized as safe and have been commonly used in the food and cosmetic Industries with a long history of safety.



Many years were spent developing a blend of ONA Liquid and various suspension elements to result in a product that has excellent dispersion qualities. The ONA odor neutralizing agents are released in a controlled manner so that every drop of this excellent product is fully optimized.

ONA industrial strength odor neutralizers are safe and environmentally friendly to use around people, pets and plants. Our essential oil-based technology consumes nearly all types of odor molecules. Other products mask odors, but ONA destroys virtually all types of odors naturally. Guaranteed!

Applications include: smoking rooms, kitchens, bathrooms, garbage storage, indoor gardens, workshops, offices, warehouses, aeration vents or anywhere odors are present.



Directions: Ona neutralizes odors by evaporating and contacting the odor molecules. Remove lid and place container in an area with good air flow. Increase odor control by pouring gel into a tray to increase evaporation. Regulate odor control by increasing or decreasing the amount of Ona exposed. For high odor areas, use a dispenser such as the: Breeze, Storm, Odor Stop, Carbon-Air or Hurricane.

The ONA Storm is ideal for neutralizing airborne odors in larger facilities such as schools, gymnasiums and office buildings. The ONA Storm, with its adjustable airflow control, evenly distributes ONA for areas up to 10,000 square feet (1,100 square meters). The ONA Storm is specifically designed to be used with ONA gel.

The ONA Storm is very practical as it can be set anywhere and has very low power requirements, maxing out at 90 watts.

225 CFM dispenser. Sits directly on a 5 gallon ONA gel container.

## 5 DISPERSION AND DILUTION

Exhaust fans (with carbon filtration) will be selected to provide high velocity discharge and mixing to further minimize the possibility of odors being detected locally:

Unit Size	Performance Range (cfm)		Nozzle Size Range	
	Minimum	Maximum	Minimum	Maximum
9	270	1,705	4	9
10	420	1,960	5	10
12	600	2,640	6	13
13	810	3,160	7	14
16	1,050	7,080	8	18
18	1,320	7,880	9	19
22	1,650	10,560	10	22
24	2,760	14,760	13	27
30	3,690	19,640	15	30
36	5,310	24,000	17	38
Nozzle Data		Effective Stack Height*		
Size (in)	Outlet Area (ft <sup>2</sup> )	Outlet Velocity (ft/min.)		
		3000	3500	4000
4	0.0873	13.4	14.0	14.5
5	0.1364	14.3	15.0	15.7
6	0.1963	15.1	16.0	16.8
7	0.2673	16.0	17.0	18.0
8	0.3491	16.8	18.0	19.1
9	0.4418	17.7	18.9	20.2
10	0.5454	18.5	19.9	21.4
11	0.6600	19.4	20.9	22.5
12	0.7854	20.2	21.9	23.6
13	0.9218	21.1	22.9	24.8
14	1.0690	21.9	23.9	25.9
15	1.2272	22.8	24.9	27.0
16	1.3963	23.6	25.9	28.2
17	1.5763	24.5	26.9	29.3
18	1.7671	25.3	27.9	30.5
19	1.9689	26.2	28.9	31.6
20	2.1817	27.0	29.9	32.7
22	2.6398	28.8	31.9	35.0
24	3.1416	30.5	33.9	37.3
26	3.6870	32.2	35.9	39.5
27	3.9761	33.0	36.8	40.7
28	4.2761	33.9	37.8	41.8
30	4.9087	35.6	39.8	44.1
32	5.5851	37.3	41.8	46.4
34	6.3050	39.0	43.8	48.6
36	7.0686	40.7	45.8	50.9
38	7.8758	42.4	47.8	53.2



## 6 BALANCED VENTILATION

### HEAT RECOVERY VENTILATORS

MODEL: BROAN - B6LCDPRN

Light commercial High Efficiency Heat Recovery Ventilator, 690 CFM at 0.4 in. w.g.



## 7 ADMINISTRATIVE ODOR MITIGATION PRACTICES

### A. Procedural activities

All products are securely stored in packaging and within odor preventing containers. Doors shall be kept shut except when access is needed.

### B. Staff training procedures

We contract with a maintenance specialist to perform the regularly scheduled maintenance of the HVAC unit including changing carbon filters to ensure zero emissions on site. The manager and assistant manager are required to keep the door to the product storage and handling rooms securely closed and locked at all times unless direct access is necessary.

### C. Recordkeeping systems and forms

Maintenance logs are kept up to date.

(all based on industry-specific best control technologies and best management practices)

Attachment 1 – Odor Control Floor Plan

**End of Plan**

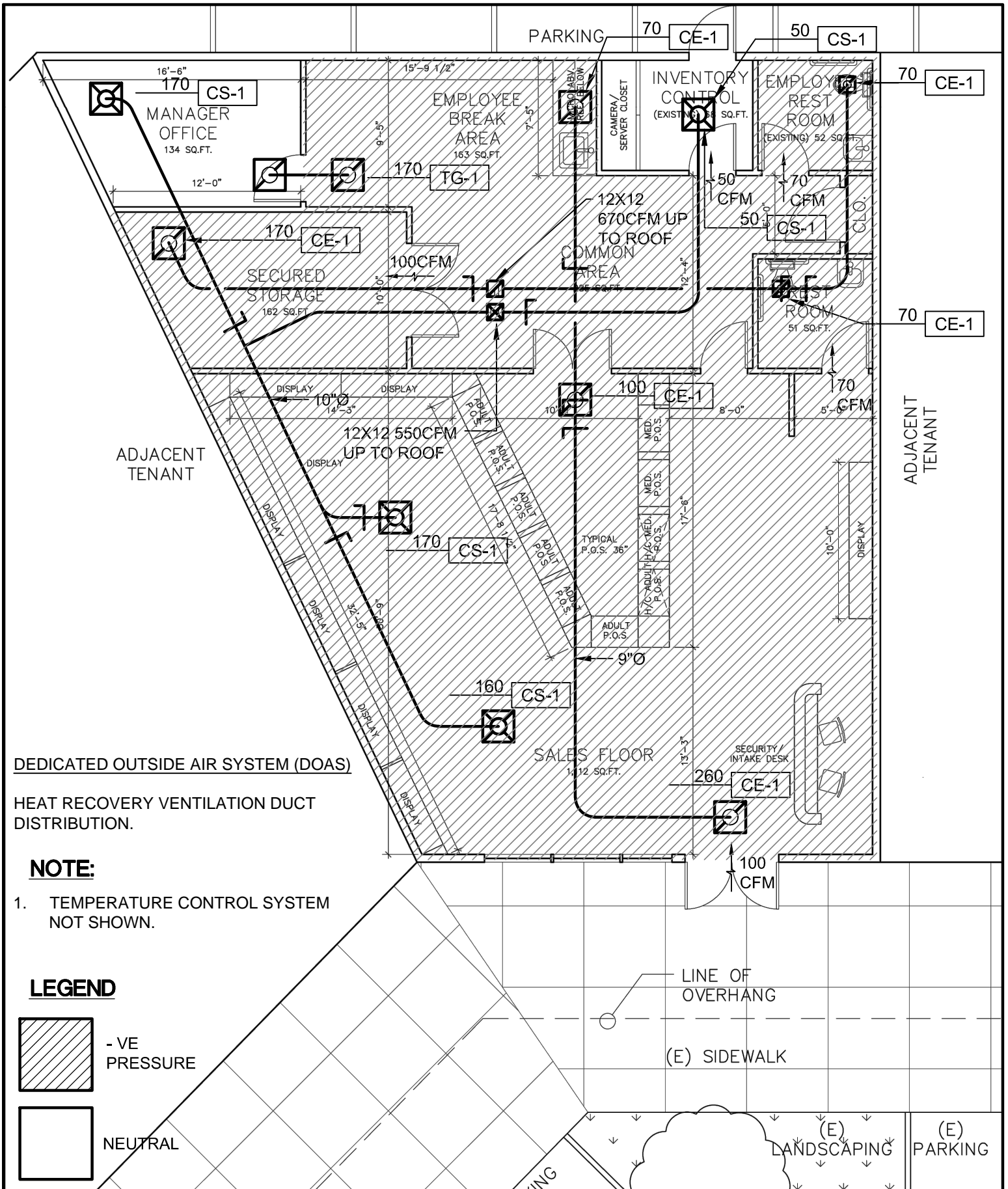

**DEDICATED OUTSIDE AIR SYSTEM (DOAS)**

HEAT RECOVERY VENTILATION DUCT DISTRIBUTION.

**NOTE:**

- TEMPERATURE CONTROL SYSTEM NOT SHOWN.

**LEGEND**

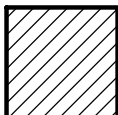

- VE PRESSURE

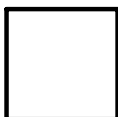

NEUTRAL

LINE OF OVERHANG

(E) SIDEWALK

(E) LANDSCAPING

(E) PARKING



**GUTTMANN & BLAEVOET  
CONSULTING ENGINEERS**

2351 Powell Street  
San Francisco, CA. 94133-1449  
P 415 625 0730 415 625 0735  
E g&b@gb-eng.com

Sheet Title:

**443 Dutton**

**ODOR CONTROL  
FLOOR PLAN**

Scale:

1/8"=1'-0"

Drawn by:

CAD DEPT

Checked by:

ENGR STAFF

Date:

03-29-2018

Job No.

FTO-001

Sheet Number:

**M1.00**



**BROAN B6LC**

**Part no. B6LC**

560 to 690 CFM (0.4 in. w.g.)



VB0240

**FOR LIGHT COMMERCIAL APPLICATIONS**

High CFM ventilation for small business owners concerned about indoor air quality (excess moisture, smoke, odors and cleanliness).

Suitable for installation above a suspended ceiling, mechanical room or suspended from a ceiling, this model delivers year-round comfort and sensible heat recovery with virtually no cross leakage. On this unit, the heat exchange efficiency can reach up to 66%.

- Only 24.5" high for false ceiling installation
- Defrost system
- Two-speed control
- Low voltage remote switch

**REPAIRS AND MAINTENANCE**

All parts of the B6LC such as the large access door and the entire motor sub-assembly can be removed for ease of maintenance. Furthermore, the electronic circuit board reduces electro-mechanical parts, minimizing repair time.

**ORDERING EXAMPLE**

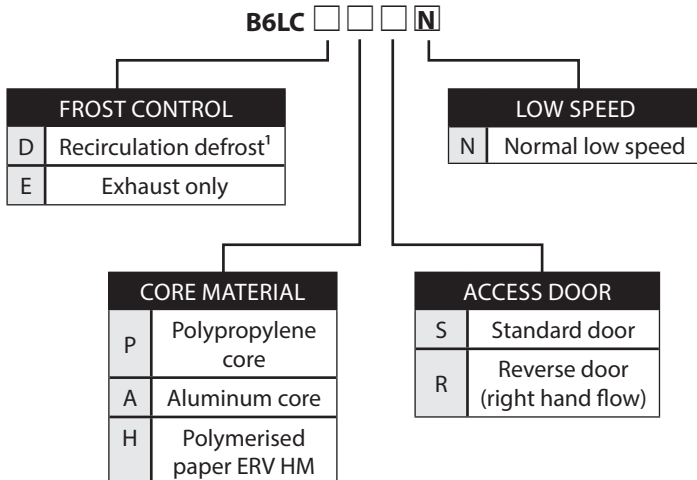

<sup>1</sup>When ordered, the recirculation defrost damper module is factory installed.

**HEAT RECOVERY VENTILATOR AND ENERGY RECOVERY VENTILATOR**

**Control**

- Built-in electronic circuit board ready to receive the VT1W main wall control.

**Heat Recovery Cores/Energy Recovery Cores**

Dimensions: 12" x 12" x 13.125"

Exchange surface: 200 ft<sup>2</sup>

Weight: HRV Polypropylene: 9.2 lb. ; Aluminum: 13.9 lb.  
ERV Polymerised paper: 11.2 lb.

Type: Plate to plate core

Quantity: 2

Material: HRV polypropylene or aluminum  
ERV polymerised paper

Warranty: HRV 15 years; ERV 5 years

A MINIMUM OF 15" [381] CLEARANCE FROM ANY OBSTRUCTION IS REQUIRED FOR REMOVAL OF CORES, FANS, ETC. THE ACCESS DOOR CAN BE REMOVED FROM CABINET WITH ONLY 2" [51] OF CLEARANCE.

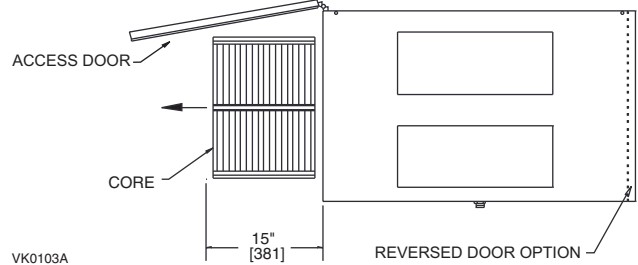

VK0103A

**Option**

- Medium efficiency air supply filters

**Recirculation or exhaust defrost**

OUTDOOR TEMPERATURE		DEFROST CYCLE (IN MINUTES)
°C	°F	DEFROST/OPERATION
WARMER THAN -5	WARMER THAN 23	NO DEFROST
-5 TO -15	23 TO 5	12/60
-15 TO -30	5 TO -21	12/24
-30 & LESS	-21 & LESS	12/12

**Requirements and standards**

- Complies with the CSA C22.2, no. 113 Standard applicable to ventilators
- Complies with UL Standard 1812 - ducted Heat Recovery Ventilators or Energy Recovery Cores

**Warranty**

The B6LC unit is fully protected by a 2-year warranty on parts, the best in the industry, and the heat recovery cores are covered by a 15-year warranty.

Available at:

# DIMENSIONS AND SERVICE CLEARANCES: B6LC

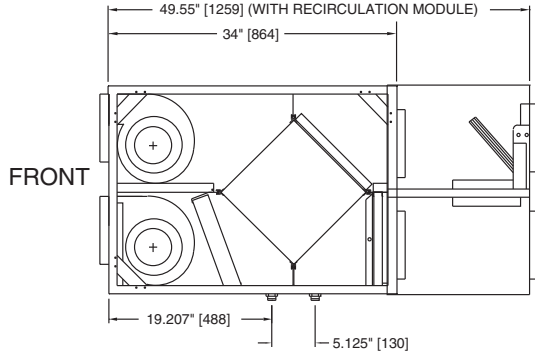
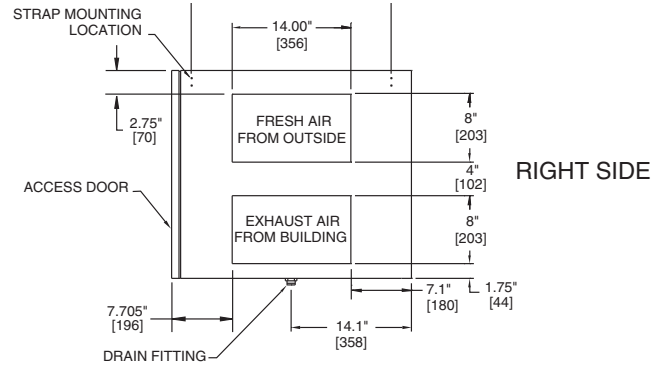
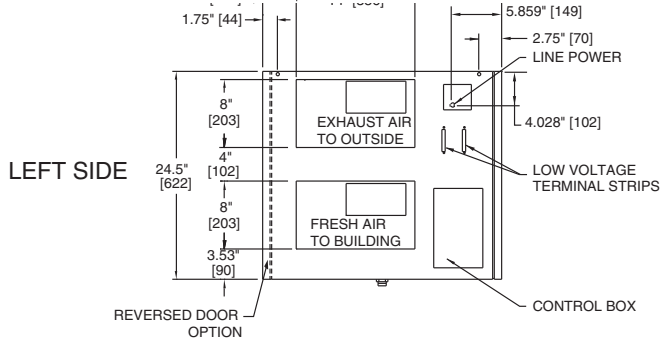

A MINIMUM OF 12" [305] CLEARANCE FROM ANY OBSTRUCTION IS REQUIRED FOR REMOVAL OF CONTROL BOX.

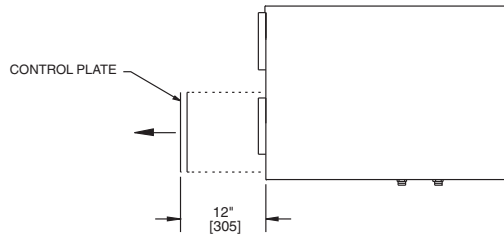

NOTE: Dimensions in brackets are in millimeters.

VK0050A NOTE: FOR UNITS WITH THE REVERSED DOOR OPTION, INTERIOR COMPONENTS WILL APPEAR AS A MIRROR IMAGE OF THE ABOVE DIAGRAM.

## PERFORMANCES

External Static Pressure		Power Consumed Watt	HRV High		ERV High		HRV and ERV			
			cfm	L/s	cfm	L/s	Medium		Low	
in. w.g.	Pascal		cfm	L/s	cfm	L/s	cfm	L/s	cfm	L/s
0.1	25	778	720	340	716	338	660	311	595	281
0.2	50	774	710	335	701	331	646	305	586	276
0.3	75	765	698	329	683	322	632	298	576	272
0.4	100	750	685	323	664	313	617	291	564	266
0.5	125	730	670	316	642	303	600	283	550	259
0.6	150	706	650	307	618	292	580	274	528	249
0.7	175	676	625	295	590	278	547	258	500	236
0.8	200	641	590	278	550	259	505	238	455	215
0.9	225	600	540	255	495	233	450	212	400	189
1.0	250	555	470	222	400	189				

## ENERGY PERFORMANCE

POLYPROPYLENE CORE				EFFECTIVENESS		
SUPPLY TEMPERATURE		NET AIR FLOW		SENSIBLE	LATENT	TOTAL
°F	°C	CFM	L/S			
HEATING						
35	1.7	400	189	57	0	38
35	1.7	300	142	63	0	42
COOLING						
95	35	400	189	55	0	21
95	35	300	142	60	0	23

ALUMINUM CORE				EFFECTIVENESS		
SUPPLY TEMPERATURE		NET AIR FLOW		SENSIBLE	LATENT	TOTAL
°F	°C	CFM	L/S			
HEATING						
35	1.7	400	189	54	0	36
35	1.7	300	142	57	0	38
COOLING						
95	35	400	189	52	0	20
95	35	300	142	56	0	21

POLYMERIZED PAPER CORE (HM)				EFFECTIVENESS		
SUPPLY TEMPERATURE		NET AIR FLOW		SENSIBLE	LATENT	TOTAL
°F	°C	CFM	L/S			
HEATING						
35	1.7	400	189	60	47	56
35	1.7	300	142	65	53	61
COOLING						
95	35	400	189	60	38	46
95	35	300	142	63	45	52

## EFFECTIVENESS

UNIT PERFORMANCE, SENSIBLE EFFECTIVENESS				
HEATING SUPPLY TEMPERATURE 35°F / 1.7°C	AIRFLOW (CFM)			
	300	400	500	600
POLYPROPYLENE	69	64	59	55
ALUMINUM	62	59	56	55
POLYMERIZED PAPER (HM)	77	75	73	71

UNIT PERFORMANCE, TOTAL EFFECTIVENESS				
COOLING SUPPLY TEMPERATURE 95°F / 35°C	AIRFLOW (CFM)			
	300	400	500	600
POLYMERIZED PAPER (HM)	49	44	41	39

NOTE: All specifications are subject to change without notice.

## ACOUSTIC NOISE POWER CHART (dBA) AT UNIT PORTS

Airflow	Fresh air to building port	Exhaust air from building port
685 CFM at 0.4 in. w.g.	76.9 dBA	61.3 dBA
586 CFM at 0.2 in. w.g.	66.1 dBA	52.5 dBA

The data shown on left chart come from measurement performed according to ISO 5136 Standard. These data represent the sound power directly measured at the fresh air distribution port and exhaust air from building port. To get the actual noise level in the room, consider noise attenuation resulting from total ductwork installation.

## SPECIFICATIONS

- Model: B6LC
- Total assembled weight:
  - With polypropylene cores: 148 lb.
  - With aluminum cores: 170 lb.
  - With polymerised paper core: 157 lb.
- All duct connections: 8" x 14"
- Drains: 3/4" fittings
- Housing: 20 ga. pre-painted steel
- Filters: 4 reticulated washable foam filters (20 ppi) and 2 optional disposable 30% medium efficiency filters
- Mounting: Reinforced rubber straps
- Insulation: 3/4" foil faced and 1" acoustic fiberglass wool
- Supply & Exhaust Blower motors:
  - Motor type: PSC motors with sealed: sleeved bearings, 3 speeds (2 available to customer)
  - R.P.M.: 1625      - H.P.: 1/4
  - Fan type: Direct drive centrifugal blower 7 1/8" x 6"
  - Housing: Galvanised steel
- Fan Speed control:
  - Low, medium & high speed
  - 2 speeds available to user
  - Low or medium speed is selected at the time of installation
- Unit electrical characteristics:
 

Volts	Amps	Watts
125	5.7	640

Project:	REMARKS
Location:	
Model no.: B6LC	
Quantity:	
Submitted by:	Date:



Broan-NuTone LLC, 926 West State Street, Hartford, WI 53027 (1-877-862-7626)



www.broan.com

B6LCd170321



## ATTACHMENT C: CANVASSING REPORT



**421 Group**

**PUBLIC AFFAIRS**

# Canvassing Report

REPORT DATE

**April 16, 2018**

CLIENT

**Phenotopia**

PROJECT LEAD(S)

**Craig Litwin, Amber Risucci,  
Lizette De Arkos**

TARGET VICINITY

**443 Dutton Ave, Ste 11  
Santa Rosa, CA 95407**



### Introduction

**As part of Phenotopia’s Public Affairs campaign, 421 Group was hired to provide canvassing services.**

Phenotopia has secured the vacant commercial space located at 443 Dutton Avenue, Suite 11, in Santa Rosa, California, and is following all required steps to ensure regulatory compliance. The space is in the Dutton Plaza shopping center.

This canvassing initiative aims to address three goals:

- 1. Familiarize** neighboring businesses with Phenotopia’s project and document any initial questions or concerns;
- 2. Identify and prioritize** the community’s most pressing concerns and favorite community organizations; and
- 3. Facilitate** an Open House at the proposed location to give neighbors a chance to provide feedback to and ask questions directly of Phenotopia.

421 Group is keenly aware of the City of Santa Rosa’s permitting requirements – and the challenges faced in implementing cannabis regulations – and, with Phenotopia, strives to take proactive steps as good actors to ensure a positive, collaborative application process.



### Canvassing Plan

#### Talking Points

In order to ensure that all 421 Group staff were in alignment on messaging and were able to represent Phenotopia consistently and effectively when speaking with community members in the target vicinity, a set of **eight key talking points** was developed, which has been reviewed and approved by Phenotopia:

#### **QUALIFIED LOCAL OPERATOR**

As a longtime resident of Santa Rosa and a family man, Phenotopia's founder and CEO Padraic Fahey is eager to improve the community he calls home, create a variety of job opportunities, and source local talent when hiring for store positions. Fahey brings some 20 years of experience in the cannabis industry: from humble beginnings in cottage cultivation, Fahey soon became an innovator in large-scale indoor growing facilities. He also brings extensive knowledge about being a buyer and a supply-chain consultant.

#### **STATE + LOCAL COMPLIANCE**

To keep the public safe, Phenotopia will be implementing a vetted security program. Further, studies have shown that, in areas with an approved dispensary, there is in fact a decrease in crime and illegal distribution of cannabis. Per regulations, and in the interests of being a good neighbor, Phenotopia has a plan for mitigating odor, noise, and other nuisances.

#### **FISCAL RESPONSIBILITY**

As a retailer generating revenue toward sales tax and cannabis taxes, Phenotopia will be contributing to the vitality of the City of Santa Rosa's General Fund, which is typically the funding source for infrastructure and other important community-improvement projects.

#### **COMMERCIAL VITALITY**

Phenotopia will benefit existing businesses by increasing overall foot traffic, especially given its central location within the Dutton Plaza shopping center. The store is also expected to attract new customers from other areas who are not yet familiar with the neighborhood's convenient mix of locally owned and operated shops, restaurants, and service providers.

#### **ENHANCED RETAIL EXPERIENCE**

Phenotopia will be making significant renovations and enhancements to the vacant commercial space, including several compliance-oriented buildouts and layout changes to improve customers' in-store experience. Premium construction materials will create a bright, welcoming, modern space. Exterior improvements include the installation of high-quality signage and the application of special window coatings that protect customers' privacy while allowing light to enter the facility.



### COMMUNITY BENEFITS

Phenotopia has pledged to foster a positive, lasting relationship with the local community, as evidenced by their commitment to (a) donating to local charities that the community has identified as being important, (b) contributing to specific area improvements and assisting with community development, and (c) supporting neighborhood-specific projects.

### NEIGHBORHOOD ENHANCEMENT

Phenotopia is dedicated to educating the community about the benefits of cannabis for health and well-being and dispelling harmful myths about its use. Phenotopia's business would provide additional cannabis access to residents who are not able to travel to other dispensaries, or to people who have been waiting for a well-situated dispensary that is conveniently accessible by car, transit, bicycle, or walking, and offers ample parking.

### COMMITMENT TO ROSELAND

Phenotopia is fully committed to being a deeply engaged member of the Roseland community. They strive to create quality job opportunities, a practical and proven way to help longtime residents continue to afford to live in neighborhoods like Roseland. They will prioritize the hiring of bilingual staff and of those who have been negatively impacted by the so-called War on Cannabis, while also creating an opportunity for people in noncompliant cannabis trade to come out of the shadows and pursue legitimate careers.

## Neighborhood-Outreach Strategy

421 Group developed Phenotopia's canvassing strategy, recorded all steps taken, and assessed the resulting data.

### CANVASSING PHILOSOPHY

421 Group strongly believes that cannabis businesses should utilize canvassing or other community-outreach techniques to evaluate the level of support for a project while capitalizing on opportunities to educate members of the community about the cannabis industry and respond to concerns raised.

Businesses that engage in neighborhood canvassing are taking the first, important step in an ongoing process of fostering strong community relations.

### SELECTION OF TARGET VICINITY

The proposed Phenotopia retail dispensary is located at 443 Dutton Avenue, Suite 11, in the recently annexed Roseland neighborhood of Santa Rosa, California. The City of Santa Rosa provided notice about the proposed dispensary to all neighboring business and residents within a 300-foot radius of the location.

To demonstrate a commitment to thorough community dialogue, 421 Group and Phenotopia have **doubled the City's standard noticing radius**, canvassing all neighbors within **600** feet of the proposed dispensary.





### LOCATION VISITS

To maximize opportunities to speak with neighboring businesses and residents about Phenotopia, 421 Group staff canvassed the target vicinity over the course of several weeks, making site visits on different days of the week and at different times of the day.

### FOLLOW-UP CONTACT

421 Group carefully tracked all engagements with members of the community and promptly followed up with selected individuals, as appropriate.

### Target Vicinity

The following address ranges were canvassed:

**250–568 Dutton Avenue      370–855 Sebastopol Road      320–400 West 3rd Street**

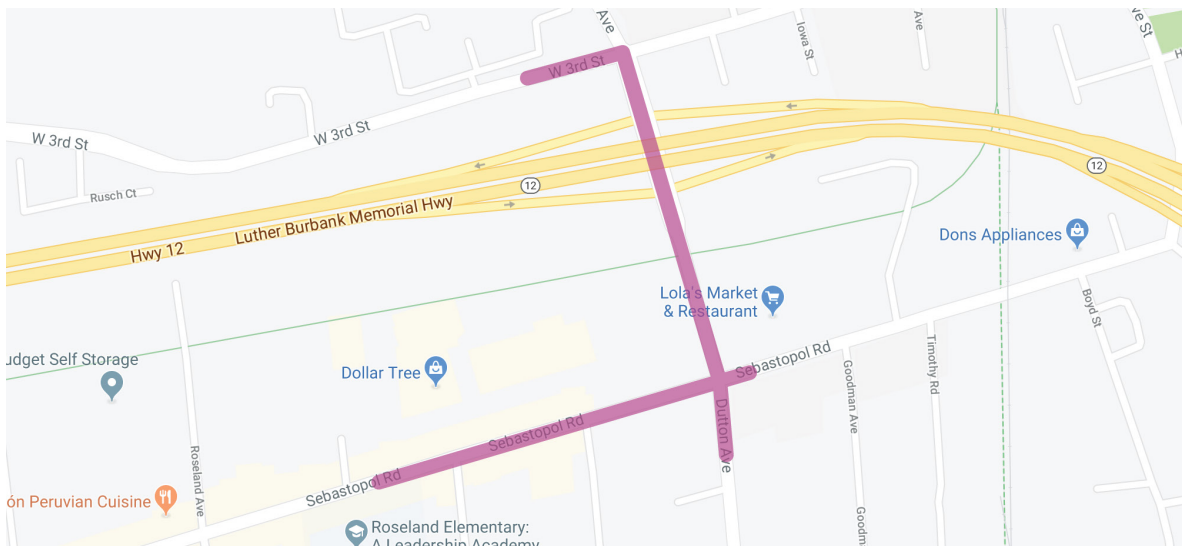

*map overview of target vicinity; base street map courtesy of Google Maps*

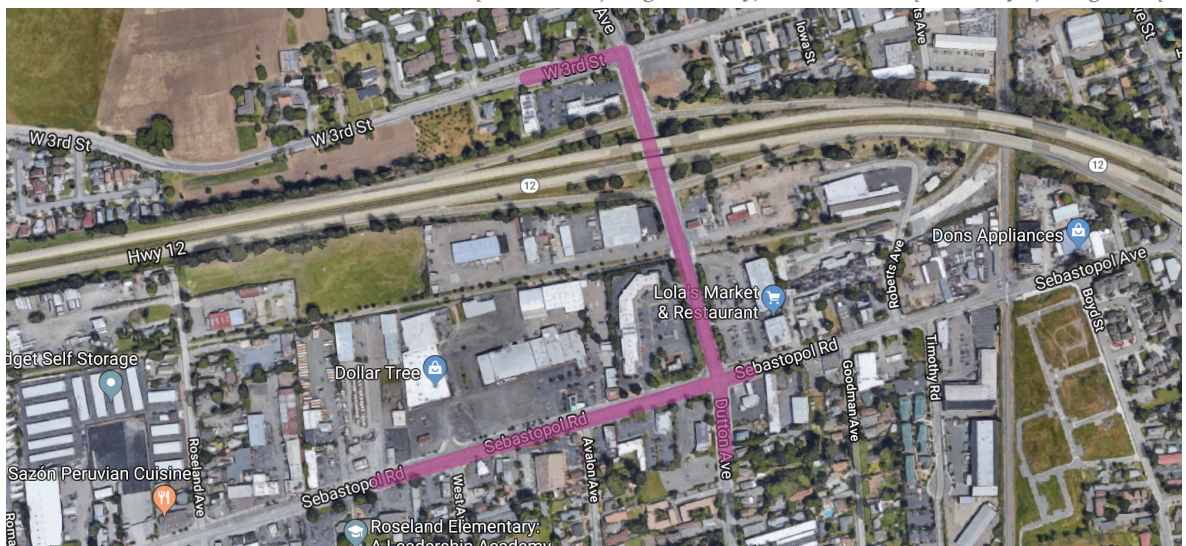

*satellite overview of target vicinity; base map courtesy of Google Maps*



Due to the proposed Phenotopia retail dispensary's proximity to Highway 12, the canvassing area straddles two main ZIP codes: 95401 to the north and 95407 to the south.

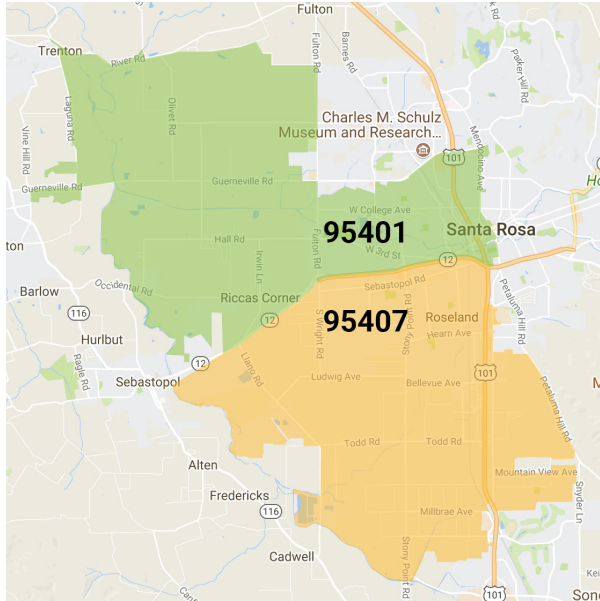

base boundary data courtesy of Zipmap.net

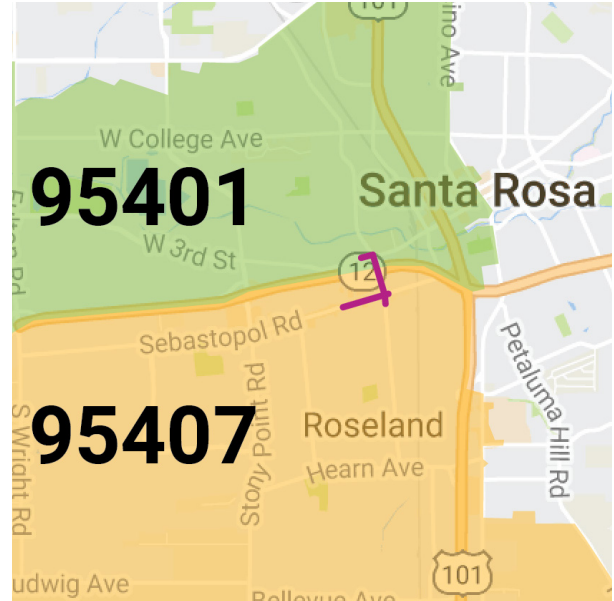

target vicinity in context of ZIP code map

By canvassing a large target vicinity and seeking feedback from various respondents, including those with a full view, a partial view, or even no view of the proposed Phenotopia retail dispensary, 421 Group was able to collect diverse yet relevant data from which to draw reasonable conclusions.



## Canvassing Results

Over the course of nine days, 421 Group canvassers visited some 56 locations and made connections with 63 of 67 potential contacts in the target vicinity of the proposed Phenotopia retail dispensary.

### Site Visits

From February 11, 2018, to March 30, 2018, 421 Group canvassers engaged with neighbors:

February 2018						
SUN	MON	TUE	WED	THU	FRI	SAT
● Initial engagement ● Additional follow-up				1	2	3
4	5	6	7	8	9	10
11	12	13	14	15	16	17
18	19	20	21	22	23	24
25	26	27	28			

March 2018						
SUN	MON	TUE	WED	THU	FRI	SAT
● Initial engagement ● Additional follow-up				1	2	3
4	5	6	7	8	9	10
11	12	13	14	15	16	17
18	19	20	21	22	23	24
25	26	27	28	29	30	31

Where additional follow-up was required, 421 Group canvassers reengaged with contacts.

Most commonly, canvassers conducted additional follow-up for three main reasons:

1. To speak with a more-senior team member, such as a supervisor or owner;
2. To speak with a team member when the business was less busy; or
3. To attempt to reach someone during varying or unknown business hours.

The target vicinity is almost entirely commercial; however, the area is not homogeneous in terms of business type or typical business hours. For example, auto-repair shops may be rarely open on weekends, restaurants may be closed on Mondays or Tuesdays, and beauty salons may be open for appointments only. To maximize the number of successful engagements, 421 Group canvassers leveraged varying days of the week and times of the day.

### Locations

Of 56 total addresses canvassed, **98% were commercial** and 2% were residential.

Given that the target vicinity is almost entirely commercial, it seems more than reasonable to assume that the proposed Phenotopia retail dispensary will blend nicely into the existing mix of businesses while also having little or no impact on residential areas.

It is important to note that only one residential location was within the target vicinity.





### Contacts

Of 67 potential contacts, **98% were commercial** and 2% were residential; **94% were reached**.

When interacting with commercial contacts, 421 Group noted the person's title and associated it with one of three role categories, with the following results:

- **57%** executive level (e.g., Owner)
- **19%** management level (e.g., Store Manager)
- **24%** staff level (e.g., Waiter)

It is important to note that only one residential contact was within the target vicinity.

### Level of Support

Among commercial respondents, 421 Group found **strong support** for the proposed Phenotopia retail dispensary.

The sole resident within the target vicinity, who is a homeowner, was confirmed by 421 Group to be in full support of the proposed dispensary.

#### **ADDITIONAL SUPPORT**

421 Group canvassers found that several community members were especially supportive of Phenotopia and we willing to lend additional support to the proposed retail dispensary. To date, there have been **seven letters of support** promised on Phenotopia's behalf; five have been received.

Of the five letters received, four are from neighboring businesses and one is from the homeowner of the only residential location within the target vicinity:

- Jorge Alcazar, Frozen Art Gourmet Ice Cream
- Monica Almanza, Income Tax Services
- Adalia Alvarez, Joyeria Maria
- Ana Meza, Mas X Menos
- Dan Mason, homeowner

A number of especially supportive community members have also agreed to attend the upcoming **Phenotopia Open House** taking place on Wednesday, April 18, 2018.



### Community Priorities

Phenotopia has pledged to foster a positive, lasting relationship with the local community, as evidenced by their commitments:

1. Donating to local charities that the community has identified as being important;
2. Contributing to specific area improvements and assisting with community development; and
3. Supporting neighborhood-specific projects.

While developing the canvassing plan with 421 Group, Phenotopia expressed a desire to identify and prioritize the community's most pressing concerns and favorite community organizations.

### Donation Priorities

In the course of the canvassing process, 421 Group collected feedback from target-vicinity contacts within the 600-foot canvassing radius. Respondents were overwhelmingly in support of donating to organizations working to alleviate **homelessness, hunger, and housing insecurity**.

421 Group is currently aggregating the final list of community-suggested organizations.



## Supplemental Community Forum

Phenotopia is fully committed to being a deeply engaged member of the Roseland community. While developing the canvassing plan with 421 Group, Phenotopia expressed a desire to facilitate an **Open House** at the proposed dispensary location to give neighbors a chance to provide feedback to and ask questions directly of Phenotopia leadership. The site-renovation and community-donation plans will also be presented during this meet-and-greet event.

### Invitations

421 Group canvassers reached out to all target-vicinity contacts within the 600-foot canvassing radius to invite them to the upcoming Open House. Given the area demographics, double-sided invitations were printed, with English on one side and Spanish on the other. 421 Group will be collecting feedback for Phenotopia at the event.

**YOU'RE INVITED**

## We want to hear from you!

On behalf of our client **Phenotopia**, 421 Group would like to invite you to our special Open House event.

As good neighbors, we'd like to offer you an opportunity to learn more about Phenotopia's plans to open a cannabis dispensary in this vacant commercial space.

We also want to share how Phenotopia plans to give back to the local community and help improve the surrounding area.

**We hope you'll join us for some delicious complementary food and beverages.**

Looking forward to meeting you!

**WHERE**  
443 Dutton Avenue, Suite 11, Santa Rosa  
in the Dutton Plaza shopping center



**ESTÁS INVITADO**

## ¡Nos gustaría escuchar su opinión!

De parte de nuestro cliente **Phenotopia**, 421 Group los invita a una reunión abierta al público.

Como buenos vecinos los invitamos aprender sobre los planes de Phenotopia de abrir un dispensario de marihuana en este espacio vacante.

También queremos compartir cómo Phenotopia planea contribuir a la comunidad local y ayudar a mejorar al vecindario.

**Acompáñenos a disfrutar comida y bebidas gratis.**  
¡Esperamos contar con su presencia!

**CUANDO**  
Miércoles, 18 de abril  
de 5:30 a 7 pm

**DÓNDE**  
443 Dutton Avenue, Suite 11, Santa Rosa  
en el centro comercial Dutton Plaza

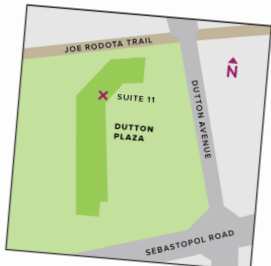



### Conclusion

Based on the canvassing results and overall level of support from members of the community, it would seem that Phenotopia is in a good position to continue moving forward with the proposed retail dispensary located at 443 Dutton Avenue, Suite 11, in Santa Rosa's Dutton Plaza shopping center.

*Submitted by Craig Litwin, Principal + President, 421 Group*

ATTACHMENT D: LETTERS OF SUPPORT

**To the City of Santa Rosa Planning Commission,**

I am employed in the Roseland area near the site of 443 Dutton Ave, Santa Rosa Ca. I am a supporter of the the new business that will be applying for a retail dispensary permit at that location.

I appreciate that it will bring added security to the area and that the business is committed to helping decrease crime. I was told that studies have shown that the illegal distribution of cannabis in areas that have an approved dispensaries. I support this change in policy.

Thank you,

DAN MASON  
*Dan Mason*  
2-23-18



Feb. 16<sup>th</sup> 2018

**To Whom it May Concern,**

I am a business owner near 443 Dutton Ave. I was contacted by a representative of the company that is applying for a dispensary permit for that location.

I would like to submit this letter in support of this new business and am particularly grateful for their dedication to educating the community on the benefits of cannabis for health and well being and their commitments to helping improved the neighborhood with their community outreach and support.

Thank you,

Jorge Alcazar

Frozen Art Ice Cream

500 Sebastopol Rd. Ste B  
Santa Rosa, CA 95407

**To Whom it May Concern,**

I am a business owner near 443 Dutton Ave. I was contacted by a representative of the company that is applying for a dispensary permit for that location.

I would like to submit this letter in support of this new business and am particularly grateful for their dedication to educating the community on the benefits of cannabis for health and well being and their commitments to helping improved the neighborhood with their community outreach and support.

Thank you,

Mónica Almanza

02/27/2018

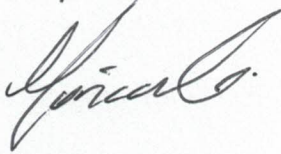
A handwritten signature in cursive script, appearing to read "Mónica Almanza".



23 febrero del 2018

Estimado Consejo Municipal de Santa Rosa,

Soy dueña de un negocio cerca de 443 Dutton Ave. Un representante del propietario de la empresa me informó que solicitarán una aplicación para poder abrir una tienda donde vendrán marihuana.

Les estoy escribiendo para expresar mi apoyo de este nuevo negocio. Creo que beneficiaremos de tener este tipo de negocio que esta sinceramente dedicado al mejoramiento de nuestro vecindario y al bienestar de los miembros de nuestra comunidad. Su compromiso para educar a la comunidad sobre los beneficios de la marihuana para la salud y el bienestar, y los nuevos empleos que crearán beneficiarán a nuestra comunidad.

También aprecio que los impuestos adicionales de este negocio de marihuana contribuyan al fondo general de la ciudad y ayudarán a mejorar a nuestro vecindario. Por favor asegúrense de que estos nuevos impuestos se asignen a la mejora del Distrito de Roseland.

Gracias,

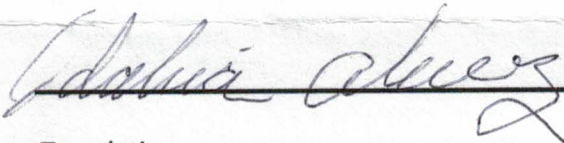

Translation:

*February 23, 2018*

*Dear Santa Rosa City Council,*

*I am a business owner near 443 Dutton Ave. I have been informed by a representative of the business owner that they will be applying for a retail dispensary permit at this location.*

*I would like to submit this letter in support of this new business. I believe that we will benefit from having this type of business that is genuinely dedicated to the improvement of our neighborhoods and the well-being of our community members. Their commitment to educating the community on the benefits of cannabis for health and wellness and the new jobs they will create will benefit our community*

*I also appreciate that the additional taxes from this cannabis business will contribute to the city's general fund and will help improve our neighborhood. Please ensure that their taxes are allocated to the improvement of the Roseland District.*

*Thank you,*



22

23 febrero del 2018

Estimado Consejo Municipal de Santa Rosa,

Soy dueña de un negocio cerca de 443 Dutton Ave. Un representante del propietario de la empresa me informó que solicitarán una aplicación para poder abrir una tienda donde vendrán marihuana.

Les estoy escribiendo para expresar mi apoyo de este nuevo negocio. Creo que beneficiáremos de tener este tipo de negocio que esta sinceramente dedicado al mejoramiento de nuestro vecindario y al bienestar de los miembros de nuestra comunidad. Su compromiso para educar a la comunidad sobre los beneficios de la marihuana para la salud y el bienestar, y los nuevos empleos que crearán beneficiarán a nuestra comunidad.

También aprecio que los impuestos adicionales de este negocio de marihuana contribuyan al fondo general de la ciudad y ayudarán a mejorar a nuestro vecindario. Por favor asegúrense de que estos nuevos impuestos se asignen a la mejora del Distrito de Roseland.

Gracias,

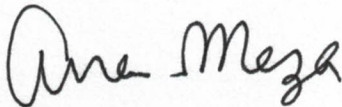

Ana Meza



---

Translation:

February 23, 2018

Dear Santa Rosa City Council,

*I am a business owner near 443 Dutton Ave. I have been informed by a representative of the business owner that they will be applying for a retail dispensary permit at this location.*

*I would like to submit this letter in support of this new business. I believe that we will benefit from having this type of business that is genuinely dedicated to the improvement of our neighborhoods and the well-being of our community members. Their commitment to educating the community on the benefits of cannabis for health and wellness and the new jobs they will create will benefit our community*

*I also appreciate that the additional taxes from this cannabis business will contribute to the city's general fund and will help improve our neighborhood. Please ensure that their taxes are allocated to the improvement of the Roseland District.*

Thank you,

# Sustainability Plan



Prepared for Phenotopia, June 08, 2018

## INTRODUCTION

This document describes Phenotopia's Sustainability Plan. The efforts are divided into five categories: **General**, **Energy**, **Water**, **Solid Waste**, and **Pollution Prevention**, each of which has a four phase plan:

- Phase I** - Focuses on policies to reduce consumption, and increase sustainable education and practices.
- Phase II** - Focuses on no cost and low cost projects.
- Phase III** - Focuses on medium and high cost projects.
- Phase IV** - Focuses on external policies and projects geared towards community benefits.

Each category has an estimated environmental impact described in terms of potential reduction in pounds of CO<sub>2</sub>, equivalent to tree seedlings grown for 10 years, and miles driven by an average passenger vehicle. Each project is analyzed based on the Three E's of Sustainability: **Environment**, **Economy**, and **Equity**.

Figure 1 summarizes the information above and highlights the yearly sustainable benefits and potential reductions associated with this plan. This program has been developed in partnership with 421 Group, which is responsible for auditing Phenotopia's efforts and overseeing its implementation team. Implementation costs, time frames, and detailed plans for projects are in development.



Figure 1: Program goal, benefits, and potential reductions per year.

Usage for an average retail space consumption are calculated based on data from the United States Environmental Protection Agency (EPA) and the Department of Energy. Consumption reductions estimated from previously implemented projects and policies. The potential reductions are based on the EPA Greenhouse Gas Equivalency Calculator.

The **Three E's of Sustainability** are defined as:

**Environment:** Environmental benefits derived from reduction of natural resource consumption. Focused on four categories: Energy, Water, Waste, and Pollution Prevention.

**Economy:** Economic benefits derived from reducing operational costs associated with resources. Focused on two categories: Internal and External economic benefits.

**Equity:** Social and community benefits associated with running a company whose sustainable values are incorporated into every facet of operations. Focused on internal well being of staff and customers, and benefitting the Roseland community through financial and political support.

## General Projects

### PHASE I

- G1. Applicant will assign a person to monitor water, energy, and waste bills to identify spikes in usage
  - a. Environmental - Identify and reduce spikes in consumption and quantify beneficial programs
  - b. Economic - Lower operational costs
  - c. Equity - Improve local environment
- G2. Applicant will post all policies in break room or visible area for employees to review
  - a. Environmental - Lower Greenhouse Gases (GHGs) associated with resource consumption
  - b. Economic - Lower operational costs
  - c. Equity - Improve local environment
- G3. Applicant will choose Green Certified vendors when available
  - a. Environmental - Lower GHGs associated with energy consumption
  - b. Economic - Lower operational costs, increase in local revenue
  - c. Equity - Improve local environment
- G4. Applicant will purchase organic or locally-grown foods and beverages for the office kitchen
  - a. Environmental - Lower need for pesticides and Vehicle Miles Traveled (VMT) associated with transportation of food
  - b. Economic - Support local economy
  - c. Equity - Improve local environment
- G5. Applicant will hire from the local community
  - a. Environmental - Lower VMTs
  - b. Economic - Support the local economy
  - c. Equity - Support local workforce

## PHASE II

- G6. Audit, re-evaluate, and implement new measures as needed to achieve highest reduction rates
  - a. Environmental - Lower GHGs associated with energy consumption
  - b. Economic - Lower operational costs
  - c. Equity - Improve local environment

## PHASE III

- G7. Audit, re-evaluate, and implement new measures as needed to achieve highest reduction rates
  - a. Environmental - Lower GHGs associated with energy consumption
  - b. Economic - Lower operational costs
  - c. Equity - Improve local environment

## PHASE IV

- G8. Applicant will support neighborhood improvement projects
  - a. Environmental - N/A
  - b. Economic - Bring new opportunities to the Roseland area
  - c. Equity - Improve local environment
- G9. Applicant will support organizations that provide Roseland neighborhood services
  - a. Environmental - Reduce blight
  - b. Economic - Bring new opportunities to the Roseland area
  - c. Equity - Improve local environment
- G10. Applicant will provide discounts for veterans, impoverished medical users, employees, and people who get to the site through alternative modes of transportation
  - a. Environmental - Lower VMTs
  - b. Economic - Keep costs down for community members
  - c. Equity - Provide access to medicine for those in need

# ENERGY

This section focuses on the reduction of energy consumption within the dispensary. Goals will be accomplished through the implementation of policies and projects concentrating on training, education, and efficient use of equipment. Figure 2 summarizes the yearly sustainable benefits and potential reductions brought by the combination of all projects and policies associated with energy.

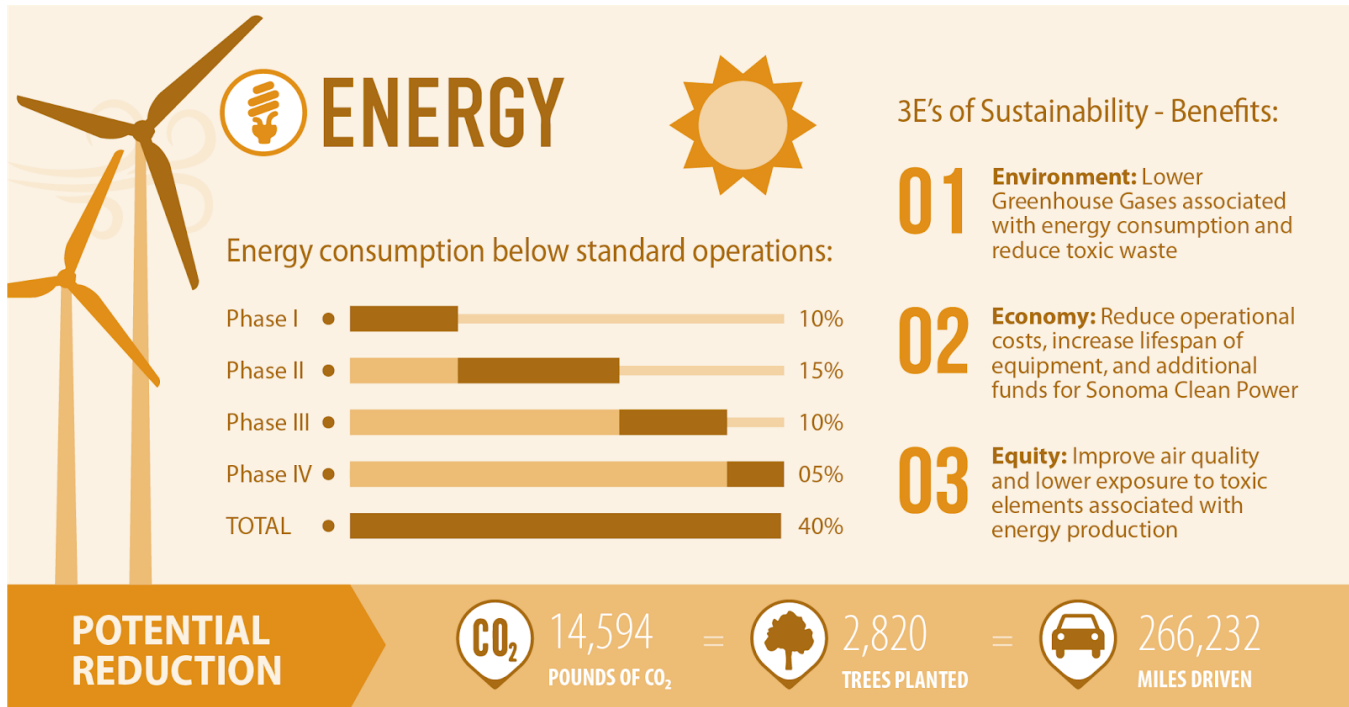

**Figure 2:** Energy initiative: benefits and potential reductions per year.

## PHASE I

- E1. Applicant will ensure all power electronic management systems are activated
  - a. Environmental - Lower Greenhouse Gases (GHGs) associated with energy consumption
  - b. Economic - Lower operational costs
  - c. Equity - Improve air quality for citizens
- E2. Applicant will implement policy that all electronic devices and lighting be turned off when not in use and use light switch reminders to turn off lights
  - a. Environmental - Lower GHGs associated with energy consumption
  - b. Economic - Lower operational costs
  - c. Equity - Improve air quality
- E3. Applicant will arrange workspace to take advantage of areas with natural light
  - a. Environmental - Lower GHGs associated with energy consumption from HVAC use
  - b. Economic - Lower operational costs
  - c. Equity - Improve air quality
- E4. Applicant will clean lighting fixtures, diffusers and lamps twice a year to increase lighting output



- a. Environmental - Lower GHGs associated with energy consumption from lighting
  - b. Economic - Lower operational costs
  - c. Equity - Improve air quality
- E5. Applicant will use task lighting instead of lighting entire area
- a. Environmental - Lower GHGs associated with energy consumption from lighting
  - b. Economic - Lower operational costs
  - c. Equity - Improve air quality
- E6. Applicant will set thermostat to 78° for cooling and 68° for heating
- a. Environmental - Lower GHGs associated with energy consumption from HVAC unit
  - b. Economic - Lower operational costs
  - c. Equity - Improve air quality
- E7. Applicant will purchase Sonoma Clean Power (SCP) Evergreen 100% renewable energy
- a. Environmental - Lower GHGs associated with energy consumption
  - b. Economic - Increase energy costs, additional funds for SCP and our Renewable Energy Portfolio
  - c. Equity - Reduce dependence on climate change causing sources of energy production, additional funds for SCP and our Renewable Energy Portfolio

## PHASE II

- E8. Applicant shall conduct regular maintenance on HVAC unit
- a. Environmental - Lower GHGs associated with energy consumption
  - b. Economic - Lower operational costs associated with HVAC unit
  - c. Equity - Hire local contractor, supporting local business
- E9. Applicant will only purchase office equipment with Energy Star certification (or equivalent efficiency)
- a. Environmental - Lower GHGs associated with energy consumption
  - b. Economic - Lower operational costs
  - c. Equity - Purchase from local, green certified business when available
- E10. Applicant will use weather stripping to seal air gaps around doors and windows
- a. Environmental - Lower GHGs associated with energy consumption
  - b. Economic - Lower operational costs
  - c. Equity - Improve air quality
- E11. Applicant will insulate all hot water pipes
- a. Environmental - Lower GHGs associated with energy consumption
  - b. Economic - Lower operational costs
  - c. Equity - Improve air quality
- E12. Applicant will use a smart programmable thermostat
- a. Environmental - Lower GHGs associated with energy consumption
  - b. Economic - Lower operational costs
  - c. Equity - Improve air quality
- E13. Applicant will apply window film to reduce solar heat gain on clear windows
- a. Environmental - Lower GHGs associated with energy consumption
  - b. Economic - Lower operational costs

- c. Equity - Improve air quality

### PHASE III

- E14. Applicant when repainting exterior or roofs will choose light colors to reflect more sunlight
  - a. Environmental - Lower GHGs associated with energy consumption
  - b. Economic - Lower operational costs
  - c. Equity - Improve air quality
- E15. Applicant will only purchase and install LED lighting
  - a. Environmental - Lower GHGs associated with energy consumption, reduction in toxic waste
  - b. Economic - Lower operational costs
  - c. Equity - Improve air quality
- E16. Applicant will install optical reflectors where appropriate to reduce number of lamps needed
  - a. Environmental - Lower GHGs associated with energy consumption
  - b. Economic - Lower operational costs
  - c. Equity - Improve air quality
- E17. Applicant will use dimmable ballasts and daylight controls such as light sensors and timers to take advantage of daylight
  - a. Environmental - Lower GHGs associated with energy consumption
  - b. Economic - Lower energy costs
  - c. Equity - Improve air quality
- E18. Applicant will use energy-efficient double-pane windows
  - a. Environmental - Lower GHGs associated with energy consumption from HVAC use
  - b. Economic - Lower operational costs
  - c. Equity - Improve air quality

### PHASE IV

- E19. Audit, re-evaluate, and implement new measures as needed to achieve highest reduction rates
  - a. Environmental - Lower GHGs associated with energy consumption
  - b. Economic - Lower operational costs
  - c. Equity - Improve air quality
- E20. Engage the community to identify new ways applicant can support local projects
  - a. Environmental - Create a healthier more vibrant natural environment
  - b. Economic - Improve the local economy through donations and support
  - c. Equity - Increase resources available to residents to support neighborhood improvement goals and build further bonds



# WATER

This section focuses on the reduction of water consumption within the dispensary. Goals will be accomplished through the implementation of policies and projects concentrating on training, education, and efficient use of equipment. Figure 3 summarizes the yearly sustainable benefits and potential reductions brought by the combination of all projects and policies associated with energy.

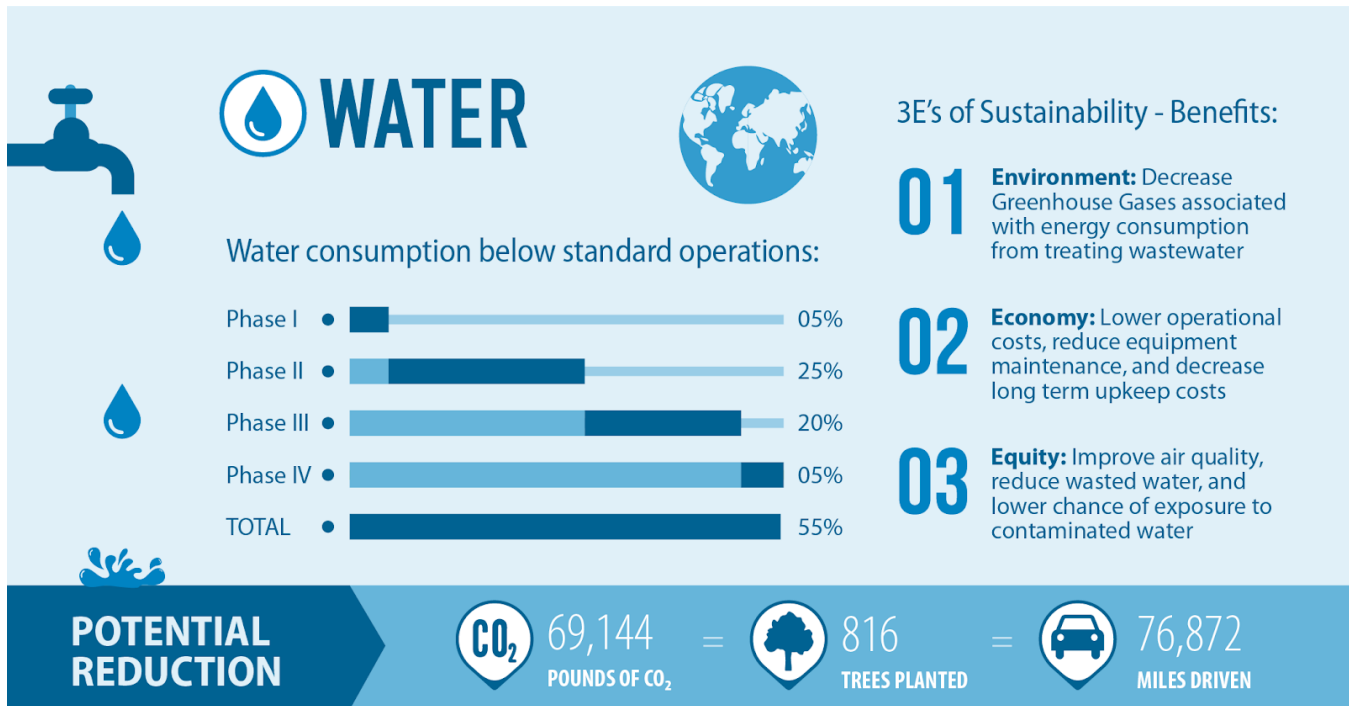

Figure 3: Water initiative: benefits and potential reductions per year.

## PHASE I

- W1. Applicant will regularly check for and repair all leaks in the facility.
  - a. Environmental - Lower Greenhouse Gases (GHGs) associated with energy consumption from moving and treating wastewater
  - b. Economic - Lower operational costs
  - c. Equity - Improve air quality, reduction in wasted water keeps water prices down
- W2. Applicant will use only dry methods to clean outdoor surfaces
  - a. Environmental - Lower GHGs associated with energy consumption from moving and treating wastewater
  - b. Economic - Lower operational costs
  - c. Equity - Improve air quality, reduction in wasted water keeps water prices down
- W3. Applicant will use dry floor cleaning methods followed by damp mopping, rather than spraying or hosing with water
  - a. Environmental - Lower GHGs associated with energy consumption from moving and treating wastewater

- b. Economic - Lower operational costs
- c. Equity - Improve air quality, reduction in wasted water keeps water prices down

W4. Applicant will clean windows on an as needed basis

- a. Environmental - Lower GHGs associated with energy consumption from moving and treating wastewater
- b. Economic - Lower operational costs
- c. Equity - Improve air quality, reduction in wasted water keeps water prices down

## PHASE II

W5. Applicant will install 0.5 gpm low flow aerators in bathrooms

- a. Environmental - Lower GHGs associated with energy consumption
- b. Economic - Lower operational costs
- c. Equity - Improve air quality

W6. Applicant will install low flow toilets, maximum 1.6 gpf

- a. Environmental - Lower GHGs associated with energy consumption from moving and treating wastewater
- b. Economic - Lower operational costs
- c. Equity - Improve air quality, reduction in wasted water keeps water prices down

## PHASE III

W7. Applicant will work with property manager to reduce water consumption associate with landscaping needs

- a. Environmental - Lower GHGs associated with energy consumption from moving and treating wastewater
- b. Economic - Lower operational costs
- c. Equity - Improve air quality, reduction in wasted water keeps water prices down

## PHASE IV

W8. Audit, re-evaluate, and implement new measures as needed to achieve highest reduction rates

- a. Environmental - Lower GHGs associated with energy consumption
- b. Economic - Lower operational costs
- c. Equity - Improve air quality

W9. Engage the community to identify new ways applicant can support local projects

- a. Environmental - Create a healthier more vibrant natural environment
- b. Economic - Improve the local economy through donations and support
- c. Equity - Increase resources available to residents to support neighborhood improvement goals and build further bonds

# SOLID WASTE

This section focuses on the reduction of upstream and downstream waste, and the diversion of landfill materials coming from the dispensary. Goals will be accomplished through the implementation of policies and projects concentrating on training, education, and proper waste set up and working with vendors to reduce waste entering and leaving the dispensary. Figure 5 summarizes the yearly sustainable benefits and potential reductions brought by the combination of all projects and policies associated with solid waste.



Figure 5: Pollution Prevention initiative: benefits and potential reductions per year.

## PHASE I

- S1. Applicant will assign a person to complete quarterly waste audits, identifying items that can be donated, reused, recycled, and composted
  - a. Environment - Reduce emissions associated with landfill gas, reduce water contamination, reduce required space for landfill sites
  - b. Economic - Reduce waste operational costs
  - c. Equity - Reduce citizens exposure to contaminated land, air and water
- S2. Applicant will divert all non-landfill materials from their waste stream
  - a. Environment - Reduce emissions associated with landfill gas, reduce water contamination, reduce required space for landfill sites
  - b. Economic - Reduce waste operational costs
  - c. Equity - Reduce citizens exposure to contaminated land, air and water
- S3. Applicant will work with vendors to eliminate upstream waste from entering organization
  - a. Environment - Reduce emissions associated with landfill gas, reduce water contamination, reduce required space for landfill sites

- b. Economic - Reduce waste operational costs
  - c. Equity - Reduce citizens exposure to contaminated land, air and water
- S4. Applicant will eliminate individual bottles of water for employees and guests. Filtered water in reusable glasses will be offered in lieu.
- a. Environment - Reduce need for raw materials and reduce resources required for recycling single use bottles
  - b. Economic - Reduce potable water costs
  - c. Equity - Reduce pollution and associated health concerns
- S5. Applicant will set copiers and printers that have duplex printing capability to default mode. New machines must have duplex printing capability.
- a. Environment - Reduce need for raw materials
  - b. Economic - Reduce paper costs
  - c. Equity - N/A
- S6. Applicant will practice efficient printing by using narrow margins, using the size reduction feature (print two pages onto one page), and posting instructions on how to load letterhead and envelopes (to avoid misprints).
- a. Environment - Reduce need for raw materials
  - b. Economic - Reduce paper costs
  - c. Equity - N/A
- S7. Applicant will discourage the printing of emails and documents
- a. Environment - Reduce need for raw materials
  - b. Economic - Reduce paper costs
  - c. Equity - N/A
- S8. Applicant will eliminate unnecessary forms, redesign forms to use less paper, or switch to electronic forms.
- a. Environment - Reduce need for raw materials
  - b. Economic - Reduce paper costs
  - c. Equity - N/A

## PHASE II

- S9. Applicant will provide customers with (non-petroleum based) reusable bags when necessary, and offer discount for customers who provide their own bag
- a. Environment - Reduce plastic pollution and consumed resources for production of single use bags
  - b. Economic - Larger upfront cost, lower long term costs
  - c. Equity - Reinforce reusable culture
- S10. Applicant will buy products in reusable returnable containers
- a. Environment - Reduce plastic pollution and consumed resources for production of single use bags
  - b. Economic - Larger upfront cost, lower long term costs
  - c. Equity - Reinforce reusable culture
- S11. Applicant will replace disposables with permanent items
- a. Environment - Reduce plastic pollution and consumed resources for production of single use bags

- b. Economic - Larger upfront cost, lower long term costs
- c. Equity - Reinforce reusable culture

S12. Applicant will reuse office paper as scratch paper

- a. Environment - Reduce need for raw materials
- b. Economic - Reduce paper costs
- c. Equity - N/A

S13. Applicant will refill toner cartridges

- a. Environment - Reduce single use plastic containers
- b. Economic - Reduce cartridge costs
- c. Equity - N/A

S14. Applicant will purchase copier/printer paper with at least 30% (100% recommended) post consumer waste

- a. Environment - Reduce need for raw materials
- b. Economic - Reduce paper costs
- c. Equity - N/A

S15. Applicant will purchase janitorial paper products with at least 35% (100% recommended) post consumer waste

- a. Environment - Reduce need for raw materials
- b. Economic - Reduce paper costs
- c. Equity - N/A

### PHASE III

S16. Applicant will donate furniture, supplies, scrap materials or use waste exchange programs where other businesses can take unwanted items

- a. Environment - Reduce need for new items
- b. Economic - Reduces disposal costs
- c. Equity - Provides less expensive alternatives for buyers

### PHASE IV

S17. Audit, re-evaluate, and implement new measures as needed to achieve highest reduction rates

- a. Environmental - Lower Greenhouse Gases (GHGs) associated with energy consumption
- b. Economic - Lower operational costs
- c. Equity - Improve air quality

S18. Engage the community to identify new ways applicant can support local projects

- a. Environmental - Create a healthier more vibrant natural environment
- b. Economic - Improve the local economy through donations and support
- c. Equity - Increase resources available to residents to support neighborhood improvement goals and build further bonds

# POLLUTION PREVENTION

This section focuses on the reduction in pollution associated with running a retail business. Goals will be accomplished through the implementation of policies and projects concentrating on training, education, and proper storage of in house items. Figure 4 summarizes the yearly sustainable benefits and potential reductions brought by the combination of all projects and policies associated with pollution prevention.

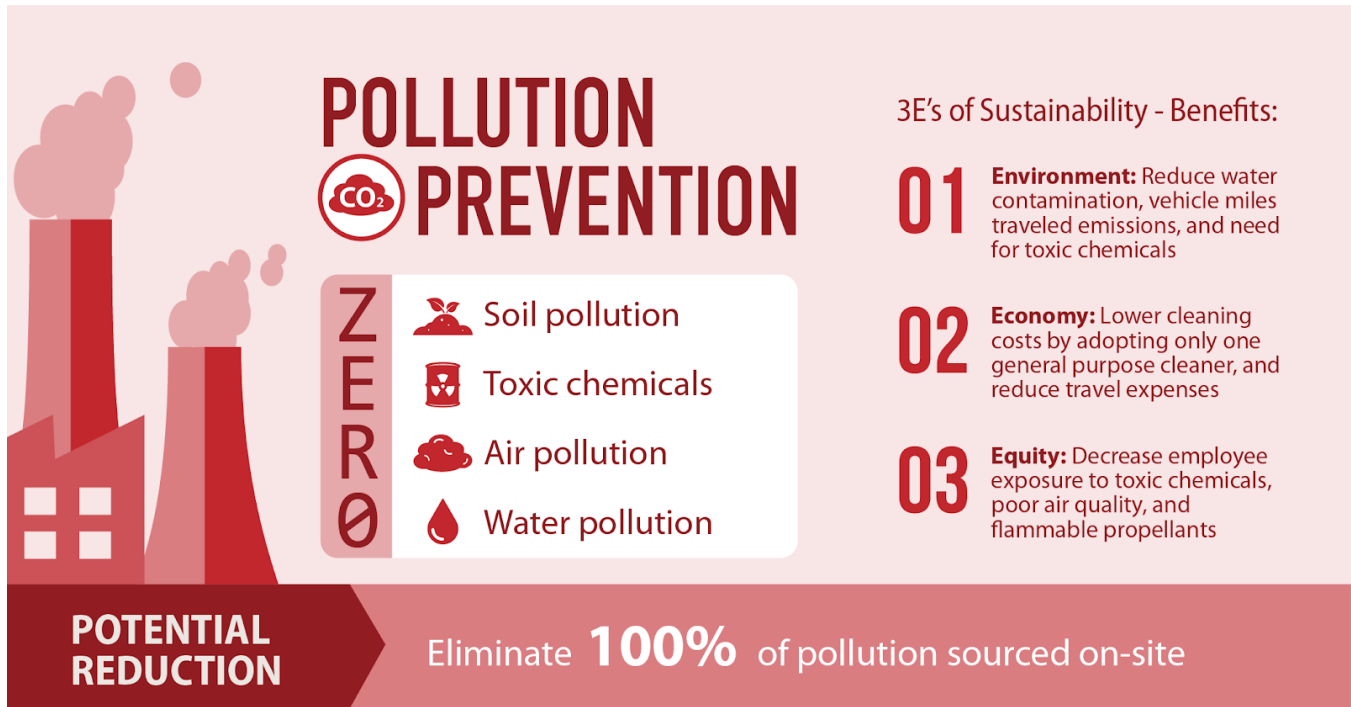

Figure 4: Pollution Prevention initiative: benefits and potential reductions per year.

## PHASE I

- P1. Applicant will check Material Safety Data Sheets and labels for all cleaning products and building maintenance materials. Identify safer alternatives. Avoid products with labels containing Prop. 65 warnings
  - a. Environmental - Reduce need for toxic chemicals, reduce water contamination
  - b. Economic - Reduction in cleaning costs by eliminating the need for multiple cleaners and choosing one general purpose cleaner
  - c. Equity - Reduce employee exposure to toxic chemicals
- P2. Applicant will dispose of any hazardous waste at our local Household Hazardous Waste Program
  - a. Environmental - Eliminate water and ground contamination
  - b. Economic - N/A
  - c. Equity - Reduce employee exposure to toxic chemicals
- P3. Applicant will routinely check for and address leaks, spills, and emissions of chemicals, paints, and cleaners
  - a. Environmental - N/A

- b. Economic - N/A
  - c. Equity - Reduce employee exposure to toxic chemicals
- P4. Applicant will ensure that nothing other than rain enters storm drains
  - a. Environmental - Reduce water contamination
  - b. Economic - N/A
  - c. Equity - N/A
- P5. Applicant will keep dumpsters covered, not overflowing and impermeable to rainwater. Keep dumpsters and parking areas clean
  - a. Environmental - Reduce water contamination
  - b. Economic - N/A
  - c. Equity - N/A
- P6. Applicant will not wash cars, equipment, floor mats or other items outside where runoff water flows to the storm drain; this wash water should be directed to a sewer drain
  - a. Environmental - Reduce water contamination
  - b. Economic - N/A
  - c. Equity - N/A
- P7. Applicant will not use products with added antibacterial agents, such as triclosan. This includes products used for handwashing, dishwashing, and cleaning
  - a. Environmental - Reduce need for toxic chemicals, reduce water contamination
  - b. Economic - N/A
  - c. Equity - Reduce employee exposure to toxic chemicals
- P8. Applicant will eliminate the routine use of all disinfectants and sanitizers, unless required by environmental health
  - a. Environmental - Reduce need for toxic chemicals, reduce water contamination
  - b. Economic - Reduction in cleaning costs by eliminating the need for multiple cleaners and choosing
  - c. Equity - Reduce employee exposure to toxic chemicals
- P9. Applicant will arrange for a single vendor who makes deliveries for several items
  - a. Environmental - Reduce associated VMT (Vehicle Miles Traveled) emissions
  - b. Economic - N/A
  - c. Equity - Reduce employees exposure to poor air quality
- P10. Applicant will when available patronize businesses close to the business
  - a. Environmental - Reduce associated VMT emissions
  - b. Economic - Reduce travel expenses and keep money in the local economy longer
  - c. Equity - Reduce employee exposure to poor air quality
- P11. Applicant will encourage employees and customers to take alternative modes of transportation when frequenting the establishment
  - a. Environmental - Reduce associated VMT emissions
  - b. Economic - Reduce traditional travel expenses
  - c. Equity - Reduce employee exposure to poor air quality

## PHASE II

- P12. Applicant will store any potentially hazardous materials securely and will control access

- a. Environmental - N/A
  - b. Economic - N/A
  - c. Equity - Reduce employee exposure to toxic chemicals
- P13. Applicant will reduce chemicals (cleaners, pesticides, paints, etc.) used and stored, disposing of any unneeded products at the local Household Hazardous Waste Program
- a. Environmental - Reduce need for toxic chemicals
  - b. Economic - Reduction in cleaning costs by eliminating the need for multiple cleaners and choosing one general purpose cleaner
  - c. Equity - Reduce employee exposure to toxic chemicals
- P14. Applicant will work with janitorial staff to use safer alternatives to potentially harmful products. Require the use of low toxic cleaning products such as those that meet Green Seal certification standards ([greenseal.org](http://greenseal.org))
- a. Environmental - Reduce need for toxic chemicals, reduce water contamination
  - b. Economic - Reduction in cleaning product costs by eliminating the need for multiple cleaners by choosing one general purpose cleaner
  - c. Equity - Reduce employee exposure to toxic chemicals
- P15. Applicant will replace all aerosols with pump dispensers, if available
- a. Environmental - Reduce propellants used
  - b. Economic - Reduction in costs
  - c. Equity - Reduce employee exposure to flammable propellants
- P16. Applicant will eliminate or reduce pesticides by using Integrated Pest Management (IPM), which includes good housekeeping, acting only when needed, making physical changes to keep pests out, and, lastly, using less or non-toxic pesticides
- a. Environmental - Reduce need for toxic chemicals, reduce water contamination
  - b. Economic - Preventative measures will keep cost associated with pests removal down
  - c. Equity - Reduce employee exposure to toxic chemicals
- P17. Applicant will use low or no-VOC paint products
- a. Environmental - Reduce indoor air contaminants
  - b. Economic - N/A
  - c. Equity - Reduce employee exposure to toxic chemicals
- P18. Applicant will offer secure bicycle storage for staff and customers.
- a. Environmental - Reduce associate VMT emissions
  - b. Economic - Reduce travel expenses
  - c. Equity - Reduce employee exposure poor air quality
- P19. Applicant will complete a CO2 or eco-footprint calculator to determine our own greenhouse gas emissions.
- a. Environmental - Increase awareness of business environmental impact
  - b. Economic - N/A
  - c. Equity - N/A
- P20. Applicant will only purchase uniforms with 100% natural materials (hemp is recommended)
- a. Environmental - Reduce microfiber pollution
  - b. Economic - N/A
  - c. Equity - Reduce employee exposure to toxic chemicals



### PHASE III

- P21. Applicant will use natural or low emissions building materials, carpets or furniture
  - a. Environmental - Reduce need for toxic chemicals, reduce water contamination
  - b. Economic - N/A
  - c. Equity - Reduce employee exposure to toxic chemicals
- P22. Applicant will print promotional materials with vegetable or other low-VOC inks.
  - a. Environmental - Reduce need for toxic chemicals, reduce water contamination
  - b. Economic - N/A
  - c. Equity - Reduce employee exposure to toxic chemicals

### PHASE IV

- P23. Audit, re-evaluate, and implement new measures as needed to achieve highest reduction rates
  - a. Environmental - Reduce need for toxic chemicals, reduce water contamination
  - b. Economic - Lower purchasing costs, and reduced travel expenses
  - c. Equity - Reduce employees exposure to toxic chemicals
- P24. Engage the community to identify new ways applicant can support local projects
  - a. Environmental - Create a healthier more vibrant natural environment
  - b. Economic - Improve the local economy through donations and support
  - c. Equity - Increase resources available to residents to support neighborhood improvement goals and build further bonds



**421 Group**

**PUBLIC AFFAIRS**

# Event Report

REPORT DATE

**June 6, 2018**

CLIENT

Phenotopia

PROJECT LEAD(S)

Craig Litwin, Amber Risucci,  
Lizette De Arkos

TARGET VICINITY

443 Dutton Ave, Ste 11  
Santa Rosa, CA 95407



## Introduction

**As part of Phenotopia's Public Affairs campaign, 421 Group was hired to provide canvassing services.**

Phenotopia has secured the vacant commercial space located at 443 Dutton Avenue, Suite 11, in Santa Rosa, California, and is following all required steps to ensure regulatory compliance. The space is in the Dutton Plaza shopping center.

This canvassing initiative aims to address three goals:

- 1. Familiarize** neighboring businesses with Phenotopia's project and document any initial questions or concerns;
- 2. Identify and prioritize** the community's most pressing concerns and favorite community organizations; and
- 3. Facilitate** an Open House at the proposed location to give neighbors a chance to provide feedback to and ask questions directly of Phenotopia.

421 Group is keenly aware of the City of Santa Rosa's permitting requirements – and the challenges faced in implementing cannabis regulations – and, with Phenotopia, strives to take proactive steps as good actors to ensure a positive, collaborative application process.

**This Event Report captures the results of Goal 3, which entailed hosting an Open House to serve as a supplemental community forum.**

For more information about the Public Affairs initiative, please refer to the Canvassing Report.



## Supplemental Community Forum

Phenotopia is fully committed to being a deeply engaged member of the Roseland community. While developing the canvassing plan with 421 Group, Phenotopia expressed a desire to facilitate an **Open House** at the proposed dispensary location to give neighbors a chance to provide feedback to and ask questions directly of Phenotopia leadership. The site-renovation and community-donation plans would also be presented during this meet-and-greet event.

### Invitations

421 Group canvassers reached out to all target-vicinity contacts within the 600-foot canvassing radius to invite them to the upcoming Open House. Given the area demographics, double-sided invitations were printed, with English on one side and Spanish on the other. 421 Group also collected feedback for Phenotopia at the event.

**YOU'RE INVITED**

## We want to hear from you!

On behalf of our client **Phenotopia**, 421 Group would like to invite you to our special Open House event.

As good neighbors, we'd like to offer you an opportunity to learn more about Phenotopia's plans to open a cannabis dispensary in this vacant commercial space.

We also want to share how Phenotopia plans to give back to the local community and help improve the surrounding area.

**We hope you'll join us for some delicious complementary food and beverages.**

Looking forward to meeting you!

**WHEN**  
Wednesday, April 18  
5:30 to 7 pm

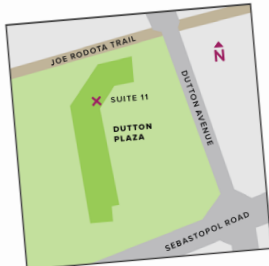

**WHERE**  
443 Dutton Avenue, Suite 11, Santa Rosa  
in the Dutton Plaza shopping center

**ESTÁS INVITADO**

## ¡Nos gustaría escuchar su opinión!

De parte de nuestro cliente **Phenotopia**, 421 Group los invita a una reunión abierta al público.

Como buenos vecinos los invitamos aprender sobre los planes de Phenotopia de abrir un dispensario de marihuana en este espacio vacante.

También queremos compartir cómo Phenotopia planea contribuir a la comunidad local y ayudar a mejorar al vecindario.

**Acompáñenos a disfrutar comida y bebidas gratis.**  
¡Esperamos contar con su presencia!

**CUANDO**  
Miércoles, 18 de abril  
de 5:30 a 7 pm

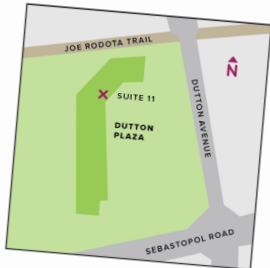

**DÓNDE**  
443 Dutton Avenue, Suite 11, Santa Rosa  
en el centro comercial Dutton Plaza



### Event Results

#### Overview

To ensure that attendees would get quality, one-on-one attention, several team members from both organizations, 421 Group and Phenotopia, were on duty at the event. All Phenotopia representatives were prepared to discuss the core talking points and answer questions about the proposed retail dispensary.

#### Attendees

Fewer than 10 people attended the event. Given the low turnout after ample promotion and personal invitations, it seems reasonable to assume that the community within the target vicinity around the proposed retail dispensary has minimal or no concerns about the project. Staff from a few neighboring businesses were unable to attend, as it was during their normal hours of operation; they nevertheless reached out to Phenotopia or sent friends to attend the event on their behalf.

#### Event Resources

Various large-format project assets were posted clearly inside the venue. Not only were attendees able to review maps, plans, and other visuals related to Phenotopia's application, they were able to see firsthand the location and interior commercial space of the proposed Phenotopia retail dispensary.

Since the event was held in the early evening, Phenotopia provided catered food and beverages from neighboring businesses in the Dutton Plaza shopping center, including tacos from Cancun Mexican Restaurant and dessert from Colores Ice Cream & Cake.

The party rentals, such as tables and chairs, were secured through another local business, Aaction Rentals. Specialty lighting was provided by Sebastopol-based Corporate Meeting AV.

#### Reflections

For a variety of reasons, Santa Rosa's Roseland district is a great place to open the proposed Phenotopia retail dispensary.

It is important to note that, for many members of the community, cannabis is a brand-new topic of conversation. Given the longtime social, racial, and legal stigmas surrounding cannabis, it can be challenging to discuss.

However, the neighbors who engaged with 421 Group and Phenotopia staff at the Open House expressed that they were grateful for the opportunity to ask questions and learn more about cannabis in a safe, welcoming environment.

Phenotopia is striving to create a dispensary that embodies that same kind of safe, welcoming space for new customers and curious neighbors alike. 421 Group is helping Phenotopia explore several ways that the proposed retail dispensary could play an educational role in the community.



## Selected Anecdotes

### Overall Opinion of Event

The Open House community event was **well received**; the neighbors were thankful for Phenotopia's willingness to talk to them and even asked us when the next party would be.

### General Reactions

During preparations for the Open House, one staffer spent extra time in and around the proposed retail dispensary space. He observed that Phenotopia will be in a busy shopping center with ample parking that serves primarily Spanish-speaking customers. He noted that numerous people were **curious about Phenotopia and expressed an interest in learning more**, and none of them seemed particularly upset by or concerned about the proposed retail dispensary opening in that space.

### Curiosity about Cannabis

Open House staffers brought meals to some of the staff at neighboring businesses. For example, a local liquor-store employee was excited to join the Open House but was not able to attend due to being on the clock; he sent a friend to find out more about Phenotopia and to bring him some food. The friend who attended was extremely interested in 421 Group and Phenotopia, and he was **enthusiastic to learn more about cannabis** and how it could help him with his recent health issues.

### Educational Opportunities

It is clear that education is a big part of what motivates Phenotopia's team; it was nice to be able to help normalize cannabis and encourage people to seek information about their options.

Given the kinds of events held in the shopping center, Phenotopia will be able to play an **invaluable role in the community** if they continue to focus on education and outreach in Spanish and English.

### General Open-Mindedness

A Spanish-speaking man from the neighborhood struck up a conversation with event staffers, stating that he had never consumed cannabis.

Staffers described how adult-use cannabis had become legal with the passage of Proposition 64. They also explained that cannabis may have medicinal properties and that many people with chronic pain, cancer, and other health concerns have used cannabis.

He told staffers that his friend's auto shop had been kicked out of the location where it had been operating, allegedly so that the landlord could instead lease the space to a cannabis cultivator.

The staffers expressed sympathy for his friend's misfortune but noted that the cultivator may not be a compliant operation. They explained that legal cannabis operations can be located only in certain zoning districts and that regulated entities must go through a Conditional Use Permit process to ensure that their business is an appropriate fit for the proposed location.

The man continued to chat with staffers, discussing plans for the Phenotopia retail dispensary. He said that, **once Phenotopia opened, he would come by** so he could try cannabis for the first time.





### Convenience of Location

A restaurant employee arrived at the very beginning of the Open House and stayed for most of the event. He said that he lives in the Roseland area and expressed **complete support for Phenotopia**. He was excited by the prospect of having access to a conveniently located dispensary. He would no longer have to take a bus to one of the other dispensaries in Santa Rosa.

When asked how people felt about Phenotopia opening in the proposed location, he said that everyone he knew was fairly positive. He expressed an interest in applying for a job at Phenotopia.

### Eagerness to Patronize Business

An elderly woman who spoke little or no English came into the proposed dispensary space during the Open House. She said that **she wanted to purchase “the marijuana” right then and there**. While event staffers were obviously unable to fulfill her request, they were nevertheless pleased to see that the proposed retail dispensary was already attracting customers.

### Support for Project

A young man who works at a nearby restaurant is going to **write a letter of support** for Phenotopia.

### Opportunity for Further Enhancements

Thanks to the rainy weather around the time of the Open House, staffers were able to identify **additional opportunities to enhance the neighborhood**. Staffers noted that most of the shopping center’s rain gutters were in need of repair and were leaking water heavily near several store entrances and walkways. The matter will be brought to the attention of Dutton Plaza management, and the repaired gutters will benefit multiple businesses and increase safety for shoppers.

### Willingness to Dialogue

One event staffer had a conversation in Spanish with two women who worked at the Angel’s Hair Salon; the women had previously received a flyer from the staffer. The women initially stated that they were attending out of pure curiosity with no particular opinion; however, it soon became clear that they were slightly opposed to the proposed dispensary and had concerns about its impact.

The staffer shared that adult-use cannabis is now legal and consumed by a diverse mix of people, including professionals like herself. They discussed how the storefront would be redesigned to be attractive yet discreet, and she explained that cannabis dispensaries are typically associated with a decrease in crime. The women seemed relieved after the conversation, saying that they were **glad to hear that Phenotopia will help improve the security** of the shopping center and that, once the proposed retail dispensary is open, they will stop by to check it out.

### Opinion among Neighboring Businesses

Other businesses in the shopping center were fine with the opening of a dispensary in the proposed location. One staffer spoke on multiple occasions with the owner of a liquor store, who seems pleased about Phenotopia; this same **positive sentiment** was echoed by Cancun Mexican Restaurant and Colores Ice Cream & Cakes.





## **Conclusion**

Based on the event results and overall level of support from members of the community, it would seem that Phenotopia is in an excellent position to continue moving forward with the proposed retail dispensary located at 443 Dutton Avenue, Suite 11, in Santa Rosa's Dutton Plaza shopping center.

*Submitted by Craig Litwin, Principal + President, 421 Group*