



Re-Evaluation of Local Limits
for the
**Laguna Subregional
Water Reclamation System
Industrial Pretreatment Program**

Prepared by:



National Experience. Local Focus.

April 18, 2019

This page is intentionally left blank

Table of Contents

Executive Summary..... **ES-1**

Chapter 1 Introduction **1**

Chapter 2 Local Limits Evaluation Process **1**

2.1 Reasons for Re-evaluation 1

2.2 Evaluation Process 1

Chapter 3 Current Conditions **3**

3.1 Facility Description 3

3.2 Existing Pretreatment Program and Local Limits 4

3.3 Data Sources 4

3.4 Screening for Pollutants of Concern 5

3.4.1 Screening of Biosolids Data 6

3.4.2 Screening of Influent and Effluent Data 6

3.4.3 Pollutants of Concern Analyzed for Maximum Allowable Headworks Loading 15

Chapter 4 Maximum Allowable Headworks Loadings **16**

4.1 Data Used in Headworks Loading Analysis 16

4.1.1 Identification of Outliers in the Data Set 16

4.1.2 Concentrations below the Minimum Quantification Level 16

4.1.3 Data Trends 17

4.2 Removal Efficiencies 17

4.3 Allowable Headworks Loadings 19

4.3.1 Facility Design Capacity for Conventional Pollutants 19

4.3.2 Water Quality Thresholds 20

4.3.3 Treatment Plant Interference 22

4.3.4 Explosivity, Fume Toxicity, Worker Exposure 23

4.3.5 Surface Disposal 23

4.3.6 Comparison of MAHLs to Actual Influent Loadings 24

Chapter 5 Revised Local Limits **28**

5.1 Calculation of Maximum Allowable Industrial Loading 28

5.2 Uncontrollable Source Loading 28

5.3 Trucked Waste 29

5.4 Calculation of MAILs and Uniform Concentration Limits 29

5.4.1 Local Limit to Remain the Same 32

5.4.2 Local Limits to be Increased to the Full Re-Calculated Value 32

5.4.3 Local Limits to be Removed 33

5.5 Revisions to Non-Technically-Based Local Limits 34

5.6 Summary of Proposed Revisions 35

List of Tables

Table 1: City of Santa Rosa Industrial Users **4**

Table 2: Screening of Organic Constituents in Biosolids **9**

Table 3: Screening of Metals and Organic Constituents in Influent **10**

Table 4: Screening of Metals and Organic Constituents in Effluent **13**

Table 5: Pollutants of Concern **15**

Table 6: Removal Efficiencies for Pollutants of Concern **18**

Table 7: Facility Design Capacity for BOD, TSS, and TKN **19**

Table 8: AHLs Based on Water Quality Thresholds21

Table 9: AHLs Based on Treatment Plant Interference22

Table 10: AHLs based on Surface Disposal Criteria.....23

Table 11: Maximum Allowable and Actual Influent Loadings for Conventional Pollutants
.....24

Table 12: Comparison of AHLs Used to Determine the MAHL.....25

Table 13: Comparison of MAHLs and Actual Influent Loading for Toxic Pollutants and
Salts26

Table 14: Average Metals Concentration (July 2016 – June 2017)29

Table 15: MAILs and Re-Calculated Uniform Concentration Limits31

Table 16: Proposed Changes to Local Limits35

Table 17: Estimated Changes in Allowable Industrial Loads.....36

Table 18: Comparison of Proposed Local Limits with Other POTWs in the Region37

List of Figures

Figure 1: Facility Flow Schematic..... 3

Figure B-1: Antimony Concentration in Facility Influent..... B-1

Figure B-2: Antimony Concentration in Facility Effluent B-1

Figure B-3: Arsenic Concentration in Facility Influent B-2

Figure B-4: Arsenic Concentration in Facility Effluent..... B-2

Figure B-5: Beryllium Concentration in Facility Influent B-3

Figure B-6: Beryllium Concentration in Facility Effluent..... B-3

Figure B-7: Cadmium Concentration in Facility Influent..... B-4

Figure B-8: Cadmium Concentration in Facility Effluent..... B-4

Figure B-9: Chromium Concentration in Facility Influent B-5

Figure B-10: Chromium Concentration in Facility Effluent B-5

Figure B-11: Copper Concentration in Facility Influent..... B-6

Figure B-12: Copper Concentration in Facility Effluent B-6

Figure B-13: Cyanide Concentration in Facility Influent B-7

Figure B-14: Cyanide Concentration in Facility Effluent..... B-7

Figure B-15: Lead Concentration in Facility Influent..... B-8

Figure B-16: Lead Concentration in Facility Effluent B-8

Figure B-17: Mercury Concentration in Facility Influent B-9

Figure B-18: Mercury Concentration in Facility Effluent..... B-9

Figure B-19: Nickel Concentration in Facility Influent..... B-10

Figure B-20: Nickel Concentration in Facility Effluent B-10

Figure B-21: Selenium Concentration in Facility Influent B-11

Figure B-22: Selenium Concentration in Facility Effluent..... B-11

Figure B-23: Silver Concentration in Facility Influent B-12

Figure B-24: Silver Concentration in Facility Effluent..... B-12

Figure B-25: Thallium Concentration in Facility Influent..... B-13

Figure B-26: Thallium Concentration in Facility Effluent B-13

Figure B-27: Zinc Concentration in Facility Influent..... B-14

Figure B-28: Zinc Concentration in Facility Effluent B-14

Figure B-29: Benzidine Concentration in Facility Influent B-15

Figure B-30: Benzidine Concentration in Facility Effluent..... B-15

Figure B-31: Bis (2-Ethylhexyl) Phthalate Concentration in Facility Influent..... B-16

Figure B-32: Bis (2-Ethylhexyl) Phthalate Concentration in Facility Effluent B-16

Figure B-33: Dibromochloromethane Concentration in Facility Influent B-17
Figure B-34: Dibromochloromethane Concentration in Facility Effluent B-17
Figure B-35: Dichlorobromomethane Concentration in Facility Influent B-18
Figure B-36: Dichlorobromomethane Concentration in Facility Effluent B-18
Figure B-37: Total Dissolved Solids (TDS) Concentration in Facility Effluent..... B-19
Figure B-38: Chloride Concentration in Facility Effluent B-19
Figure B-39: Sodium Concentration in Facility Effluent..... B-20
Figure B-40: Biochemical Oxygen Demand (BOD) Concentration in Facility Influent ... B-21
Figure B-41: Biochemical Oxygen Demand (BOD) Concentration in Facility Effluent... B-21
Figure B-42: Total Suspended Solids (TSS) Concentration in Facility Influent B-22
Figure B-43: Total Suspended Solids (TSS) Concentration in Facility Effluent..... B-22
Figure B-44: Total Kjeldahl Nitrogen (TKN) Concentration in Facility Influent..... B-23
Figure B-45: Total Nitrogen Concentration in Facility Effluent (Calculated)..... B-23
Figure B-46: Molybdenum Concentration in Biosolids B-24
Figure B-47: Benzidine Concentration in Industrial Wastewater..... B-24
Figure B-48: Selenium Concentration in Industrial Wastewater..... B-25
Figure B-49: Bis (2-ethylhexyl) phthalate Concentration in Industrial Wastewater..... B-25

Appendices

- Appendix A - Current Local Limits**
- Appendix B - Plots of Facility Monitoring Data**
- Appendix C - Halogenated TTO Local Limit**

List of Abbreviations

AHL	Allowable Headworks Loading
BOD	Biochemical Oxygen Demand
BTEX	Benzene, Toluene, Ethylbenzene, Xylene
CFR	Code of Federal Regulations
City	City of Santa Rosa
DNQ	Detected, Not Quantified
lb/day	pounds per day
MAHL	Maximum Allowable Headworks Loading
MAIL	Maximum Allowable Industrial Loading
MCL	Maximum Contaminant Level
MDL	Method Detection Limit
µg/L	micrograms/liter
mg/L	milligrams/liter
MGD	Million Gallons per Day
NPDES	National Pollutant Discharge Elimination System
PCBs	Poly-Chlorinated Biphenyls
POTW	Publicly-Owned Treatment Works
SIU	Significant Industrial User
TDS	Total Dissolved Solids
TKN	Total Kjeldahl Nitrogen
TPH	Total Petroleum Hydrocarbons
TSS	Total Suspended Solids
TTO	Total Toxic Organics
USEPA	United States Environmental Protection Agency

Executive Summary

The City of Santa Rosa (City) establishes local limits for specific pollutants in its Sewer Use Regulations found in Title 15-08.100 of the City's Municipal Code. The Sewer Use Regulations also include narrative requirements prohibiting discharge of pollutants to the City's Wastewater Treatment Facility (Facility) that could result in violation of applicable requirements or interference with Facility operation. In this report, the City has re-evaluated its local limits to determine whether existing local limits would protect the Facility from exceeding effluent limitations contained in the Facility's National Pollutant Discharge Elimination System (NPDES) permit, as well as enable the City to meet its other compliance and operational requirements and objectives.

The evaluation methodology follows the procedures documented in the United States Environmental Protection Agency (USEPA) July 2004 *Local Limits Development Guidance*. In re-evaluating local limits, the City considered Facility operational and regulatory criteria, including:

- Meeting NPDES permit effluent limitations
- Maintaining recycled water quality
- Meeting biosolids quality requirements based on current disposal methods
- Preventing interference with treatment processes, including overloading of the Facility beyond its rated design capacity
- Maintaining worker health and safety

For each pollutant of concern, this report identifies allowable headworks loadings that will ensure continued compliance with specific regulatory requirements. The lowest (most stringent) of the allowable headworks loadings for each of these pollutants was designated as the maximum allowable headworks loading (MAHL).

After factoring in sources from uncontrollable sources (domestic and commercial dischargers), revised local limits were calculated based on the MAHLs. The results of this analysis indicate that the City's current local limits should be revised as follows:

- **Remove** local limits for BOD, TSS, TKN, as these are controlled with high-strength surcharges and the local limits are redundant.
- **Remove** local limits for antimony, beryllium, hexavalent chromium, selenium, thallium, and TTO. The current local limits do not appear to be technically-based, and local limits are not needed for the following reasons:
 - Total influent loads of antimony, beryllium, selenium and thallium are less than 20% of their respective MAHLs, and these constituents are not expected to be present in industrial user discharges at levels of concern.
 - The Facility TTO Local Limit is the same as the Federal Categorical in 40 CFR 433, making the TTO Local Limit redundant.
 - The limit for hexavalent chromium will be consolidated with the limit for total chromium.
- **Maintain** current local limits for TDS, arsenic, chromium, cyanide, lead, and mercury.
- **Modify** the local limit for pH to standardize the limit for all users, including for industrial users.
- **Modify** the local limit for Total Petroleum Hydrocarbons - Gas & Diesel to apply to groundwater dischargers only.

- **Modify** the local limit for halogenated organics, applicable only to groundwater dischargers, to specify a detection limit used in the summation and to narrow the list of constituents included in the definition.
- **Increase** the local limits for cadmium, copper, nickel, silver, and zinc to reflect current removal efficiency through the treatment plant, decreased total flows from industrial dischargers compared to historical values, and other factors.

The proposed changes to local limits are a “substantial modification” to the City’s pretreatment program as described in 40 CFR 403.18(b)(2), as they constitute a change to local limits that could increase industrial loadings of certain pollutants to the Facility. The City must therefore submit information about the proposed change to the North Coast Regional Water Quality Control Board and USEPA for review and approval. The regulatory review period may extend for up to 180 days and must be followed by public notice and opportunity for comment. The City may formally revise local limits upon completion of the public review and regulatory approval process.

Chapter 1 Introduction

The City of Santa Rosa (City) owns and operates a wastewater treatment facility (Facility), a publicly-owned treatment works (POTW) regulated under NPDES Permit Number CA0022764. This NPDES permit (Permit) was most recently reissued by the North Coast Regional Water Quality Control Board (Regional Water Board) under Order No. R1-2013-0001. To fulfill the requirements of the NPDES permit, the City operates an Industrial Pretreatment Program that was initiated in 1975 and approved by the US Environmental Protection Agency (USEPA) and Regional Water Board in 1983. Local Limits are one important aspect of this Pretreatment Program, as they help to protect the Facility from industrial discharges that may interfere with operations or pass through the Facility.

The local limits that are the subject of this report have not undergone a complete update in more than 20 years, although the City has performed periodic checks and implemented partial updates during that time. This report includes a description of the process used to assess the appropriateness of the City's current local limits, and recommendations for maintaining, modifying, or removing the current local limits.

Chapter 2 Local Limits Evaluation Process

2.1 Reasons for Re-evaluation

This local limits evaluation is based on the USEPA's July 2004 *Local Limits Development Guidance* (833-R-04-002A) (Local Limits Guidance), and takes into consideration the following changes since the City's last local limits re-evaluations were conducted for toxic pollutants in 1990 and conventional pollutants in 2000:

- Implementation of corrosion control measures by Sonoma County Water Agency has resulted in reduced corrosion of water pipes, significantly reducing the metals loading to the Facility.
- The City's current Permit has water quality-based effluent limitations that significantly differ from the conditions under which the current local limits were developed. For example, the Permit no longer contains water quality-based effluent limitations for copper, lead, nickel or cyanide, although objectives for these constituents are still applicable.
- Removal efficiencies through the Laguna Treatment Plant may have changed since the current local limits were developed.
- Industrial flows are significantly lower than when the current local limits were developed.
- Remaining industrial facilities have implemented Best Management Practices and product substitution to further minimize priority pollutants.
- The City may wish to remove local limits for some constituents that are unlikely to be present in industrial wastewater and are not USEPA pollutants of concern (USEPA, 2004) -- for example, antimony, beryllium, and thallium.
- The City now provides recycled water for recharge of the Geysers steam fields, with concomitant water quality standards.

For reference, the City's current local limits are listed in **Appendix A**.

2.2 Evaluation Process

This local limits re-evaluation follows a four-step process, and each of these steps is described as follows:

Step 1. Assess current conditions to determine whether existing Maximum Allowable Headworks Loadings (MAHLs) should be recalculated or reallocated, or additional local limits should be developed. Also determine which pollutants need to be further evaluated and for which criteria.

Chapter 3 of this report describes current conditions at the Facility and the assessment of pollutants to determine which require further evaluation. MAHLs were re-calculated for all pollutants of concern identified during this assessment.

Step 2. Based on the pollutants and criteria identified in Step 1, determine whether existing data are sufficient.

Data sources are also briefly described in **Section 3.3**. Existing data were sufficient to conduct the evaluation, as described in **Section 4.1** of this report.

Step 3. Re-calculate the MAHLs of pollutants for which local limits have been developed, and determine MAHLs for new pollutants.

Chapter 4 of this report provides the MAHL calculations for all pollutants of concern as determined in the screening described in Chapter 3, and compares those MAHLs to actual influent loading to determine which pollutants require revised local limits.

Step 4. Implement the local limits.

Chapter 5 of this report includes re-calculated local limits for the City's existing technically-based local limits, as well as recommendations for other local limits.

Chapter 3 Current Conditions

3.1 Facility Description

The City owns and operates the Facility, which provides tertiary treatment of wastewater from domestic, commercial, and industrial sources. The Facility’s service area includes the City of Santa Rosa; the unincorporated South Park County Sanitation District; as well as the City of Cotati, City of Rohnert Park, and City of Sebastopol. Flows from domestic and industrial users are combined upstream of the influent monitoring station (INF-001). Hauled waste receiving also is located upstream of this influent monitoring station.

The Facility influent flow is treated by grit removal in aerated grit chambers, sludge and scum removal in primary sedimentation tanks, biological secondary treatment (activated sludge) with alum coagulation, flocculation, and clarification followed by tertiary filtration and ultraviolet light disinfection. A flow schematic is shown below in **Figure 1**.

Figure 1: Facility Flow Schematic

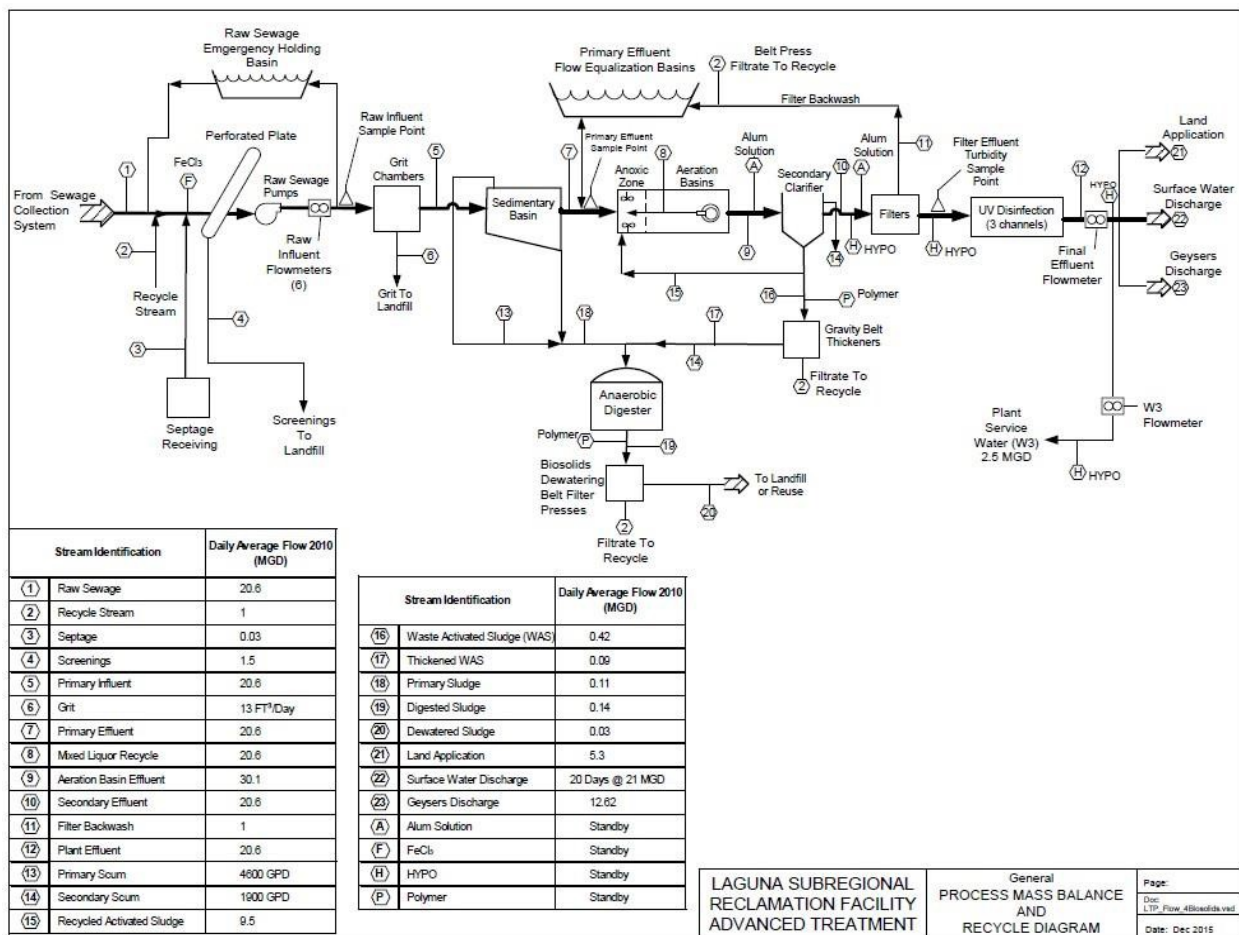

Nearly all final effluent is beneficially reused as recycled water, either for recharge of the Geysers steam fields or for urban and agricultural irrigation. During the winter, in times of high rainfall and correspondingly high flow into the Facility, the City is permitted to discharge tertiary-treated effluent to surface waters, either Santa Rosa Creek or the Laguna de Santa Rosa. Final effluent can be routed to surface

water discharge either directly after treatment (Discharge Point 015) or after storage in Delta Pond (Discharge Point 012A & 012B) or Meadow Land Pond D (Discharge Points 006A & 006B).

Solids removed from the wastewater stream are thickened, anaerobically digested, dewatered using belt filters and polymer addition, and beneficially used as soil amendment (biosolids). Based on daily sludge wasting in 2011-2016, the City produces approximately 3,770 dry metric tons per year. Biosolids are composted for unrestricted use, land applied on local farms, and sent to a landfill for disposal.

3.2 Existing Pretreatment Program and Local Limits

Local limits are designed to protect the Facility from industrial discharges that may inhibit or otherwise interfere with Facility operations and/or Permit compliance. These standards apply to discharges to the Subregional wastewater collection system, and are listed in Santa Rosa City Code §15-08.100 and comparable codes for the other four Subregional partners -- the City of Rohnert Park, City of Sebastopol, City of Cotati, and South Park County Sanitation District.

In addition to local limits, Article I of SRCC §15-08 contains General Sewer Use Requirements with narrative prohibitions against substances that cause pass-through or interference, as well as prohibitions on the discharge of specific substances such as PCBs and pesticides (SRCC §15-08.070). These prohibitions apply to all users, not just Significant Industrial Users.

Other sections of Santa Rosa City Code establish procedures for regulating non-domestic wastewater discharges, including the wastewater discharge permitting process and industrial user monitoring requirements (SRCC §15-08, Article II through VI). Current local limits are presented in **Appendix A**.

Table 1 below shows the industrial users that the City currently regulates under its pretreatment program, including both Significant Industrial Users (SIUs) and Categorical Industrial Users (CIUs).

Table 1: City of Santa Rosa Industrial Users

Industrial User	Permit Type
AlSCO American Linen	SIU
Amy's Kitchen - Northpoint	SIU
Deposition Science, Inc.	CIU
Keysight Technologies	CIU
Miller Manufacturing, Inc.	CIU
Milner's Anodizing	CIU
Republic Services of Sonoma County, Inc.	SIU
Viavi Solutions, Inc.	CIU

3.3 Data Sources

Data collected over a five-year period were used in this evaluation. The following data were used in this evaluation:

- Facility influent and effluent monitoring data for flow rate, Biochemical Oxygen Demand (BOD), Total Suspended Solids (TSS), and Total Kjeldahl Nitrogen (TKN), November 2011 – October 2016.
- Quarterly facility influent and effluent monitoring data for priority pollutants, October 2011 – July 2016. These data have been previously submitted to the Regional Water Board in the pretreatment section of the Annual Report for the Laguna Subregional Water Reclamation System.
- Monthly Facility effluent monitoring data for ammonia, nitrate, nitrite, and organic nitrogen, February 2014 – October 2016.

- Quarterly facility biosolids pollutant data, January 2012 – December 2016.
- Industrial user flow data, 2012-2016.

3.4 Screening for Pollutants of Concern

The list of “pollutants of concern” that warrant further evaluation was developed prior to more detailed evaluation. Constituents were screened for inclusion if they met any of the following criteria:

- A. **Current Local Limits.** All constituents with local limits under the City’s current pretreatment program were initially included (see **Appendix A**), with the following exceptions:
 - **Organics Regulated as a Sum.** Constituents that contribute to Total Toxic Organics (TTOs), Halogenated TTOs, and BTEX were considered individually rather than in sum. The City’s local limits identify the constituents included as TTOs, Halogenated TTOs, and BTEX, as listed in **Appendix A** of this report.
 - **Chromium-VI.** The City does not conduct monitoring for hexavalent chromium at the Plant, and this local limit is proposed to be consolidated with that of total chromium’s. Therefore, it was not evaluated separately as a pollutant of concern, only in tandem with total chromium.
 - **pH.** The City’s current local limits specify that the pH must remain between 5.5 and 11.9. The local limit applies only to SIUs and is more stringent than the prohibition for all users, which requires the pH to fall between 5.0 and 12.0 (SRCC Code §15-08.070 (B) (2)). The City plans to standardize the pH limit so that the range of 5.0 to 12.0 is applicable to all users, including industrial users.
 - **Total Petroleum Hydrocarbons – Gas & Diesel.** The City does not conduct monitoring for TPH at the Plant, and there is no longer a USEPA-approved method for this constituent in wastewater. The current local limit for TPH was not quantitatively assessed due to a lack of available monitoring data. Based on these considerations, the City proposes a change to the method and applicability of this limit (see Section 5.5).
- B. **National Pollutants of Concern.** This is a list of 15 pollutants identified by USEPA that are often found in biosolids and effluent of POTWs. The City already conducts biosolids or effluent monitoring of all 15 of these pollutants.
- C. **Existing Effluent Limitations.** The City’s NPDES permit contains limits for four constituents relevant to this evaluation: BOD and TSS as technology-based effluent limits, and dibromochloromethane and dichlorobromomethane as water quality-based effluent limits.

The NPDES permit also contains effluent limits for nitrogen and phosphorus based on the water quality objectives for dissolved oxygen and biostimulatory substances (i.e., nutrients). However, the total nitrogen performance-based effluent limitation of 10.6 mg/L and total phosphorus “no net loading” requirement in the NPDES Permit were *not* used in the evaluation. The City only complies with these limits while discharging to surface water (typically during very wet weather); due to the limited applicability of the effluent limits, they are not appropriate to use for developing local limits. Information on influent and effluent concentrations and removal efficiency is included for reference in **Table 6** of Chapter 4.

In addition to the constituents already listed under items A or B above, the NPDES permit also requires monitoring for total coliform bacteria, radioactivity, and constituents relevant to reclamation (TDS, chloride, boron, sodium, and Title 22 drinking water constituents).

- D. **Biosolids.** Disposal of the City’s biosolids are by land application or disposal as alternative daily cover at a landfill, as well as composting. Thus, the disposal is subject to regulations found within

40 CFR §503.13 Table 3 for land application, which includes limits on 9 metals, all of which are also found on the national pollutants of concern (see Item B, above). The disposal is also subject to landfill disposal limits within 22 CCR §66261.24(a)(2)(A), which includes limits on both metals and organics on a wet-weight and leachate basis.

- E. **Constituents with Potential for Treatment Plant Interference.** Screening for treatment plant interference was based on literature values found in Appendix G of the Local Limits Guidance. Constituents that were listed for inhibition of activated sludge and/or anaerobic digestion were screened for inclusion if they were detected in effluent, influent, or biosolids (see Item G below).
- F. **Constituents with Potential to Endanger the Treatment Works, Collection System, and Workers.** Appendices I and J of the USEPA Local Limits Guidance list constituents that may be explosive or produce toxic fumes. Only those constituents that were detected in effluent, influent, or biosolids were considered (see Item G below).
- G. **Organic Constituents Detected in Effluent, Influent, or Biosolids.** Individual constituents were included only if they were detected at levels above the reporting limit or between the reporting limit and method detection limit (Detected-Not-Quantified, or DNQ). If so, additional screening was performed as described below.

The data set for most organic constituents in Facility influent, effluent, and biosolids consists primarily of non-detects, estimated values, and/or detections at a very low concentration. Each of the potential constituents of concern received further screening using the procedures described below to determine whether its presence would potentially warrant a new local limit. This approach is preferable to immediately calculating a MAHL for each organic constituent because of the significant bias introduced into the MAHL calculations by non-detects and estimated values.

3.4.1 Screening of Biosolids Data

Concentrations of constituents detected in biosolids were compared with the land application and landfill disposal limits. Literature inhibition values for anaerobic digestion were also included in the comparison for added conservatism. Constituents with existing local limits (e.g., metals) were not included in this preliminary screening step, because they were automatically included in the list of pollutants of concern.

Molybdenum is the only national pollutant of concern monitored in biosolids, but not monitored in the influent or effluent. The maximum detected molybdenum concentration in biosolids over the period 2011-2016 was 11 mg/kg. Since the detected concentrations in biosolids were much lower (less than half) of the corresponding landfill application ceiling concentration of 75 mg/kg, molybdenum is not considered a pollutant of concern, and it was excluded from further analysis. Molybdenum biosolids sample results are shown in **Appendix B**.

All the maximum detected concentrations of organic constituents in biosolids were at least one order of magnitude below the lowest applicable criteria, and as such, were not considered for further analysis. A detailed summary of the biosolids screening step is shown in **Table 2**, below. Constituents without applicable limits are not included in the summary table.

3.4.2 Screening of Influent and Effluent Data

Concentrations of constituents detected in Facility influent and effluent were compared with the lowest applicable criteria among the following:

- Effluent limitations in the City's NPDES Permit (Table 4 and Table 5 of Permit)
- Lowest applicable water quality criteria identified in the Reasonable Potential Analysis for Priority Pollutants (Attachment F of Permit, Table F-13 and Table F-14)

- National Drinking Water Primary and Secondary MCLs, as well as Primary and Secondary Maximum Contaminant Levels (MCLs) established in Title 22 of the California Code of Regulations, Section 64431 (Inorganic Chemicals), Section 64444 (Organic Chemicals), and Section 64439 (Secondary MCLs)
- Inhibition values for activated sludge and anaerobic digestion from Appendix G of USEPA's 2004 *Local Limits Development Guidance - Appendices*
- Fume toxicity, flammability screening, and worker exposure levels from Appendix H, I, and J of USEPA's 2004 *Local Limits Development Guidance – Appendices*
- Water quality standards for acceptance into the Geysers pipeline, per the *Agreement to Convey Recycled Water By and Through Geysers Pipeline for Reuse* (July 2007).

Constituents that were only detected as a single occurrence out of all samples were eliminated during the screening process as outliers. It is not feasible to conduct a quantitative headworks loading analysis for constituents with just one detected value, and removing them is consistent with Section 3.2.8 and Section 5.1.3 of USEPA's Local Limits Guidance. Constituents for which the maximum detected concentration is less than half of the lowest criterion were also not considered for further analysis.

For the Facility influent, the following constituents were detected at maximum concentrations above half of the lowest criterion:

- Benzidine
- Bis (2-ethylhexyl) phthalate
- Dibromochloromethane
- Dichlorobromomethane

Constituents that were similarly flagged, but are already local limits to be re-evaluated include copper, cyanide, lead, and zinc.

For the Facility effluent, the following constituents were detected at maximum concentrations above half of the lowest criterion:

- Bis (2-ethylhexyl) phthalate
- Dibromochloromethane
- Dichlorobromomethane
- Chloride
- Sodium

Constituents that were similarly flagged, but are already local limits to be re-evaluated include copper, zinc, and TDS. Nitrate and nitrite samples were also detected above the lowest criterion, but were not included for further analysis because they are considered implicitly with the TKN local limit.

Note that dissolved salts (TDS, sodium, chloride) were not monitored in the influent, but were assumed to be equal in influent and effluent; salts are not removed in the treatment process. The City currently has a local limit for TDS. For this re-evaluation, sodium, chloride, and TDS were evaluated separately to ensure that the City is maintaining an appropriate local limit. Aside from dissolved salts, boron is another parameter that is important to consider for recycled water. Because its maximum detected concentration was less than half of the lowest applicable criterion, boron was not considered for further analysis as a pollutant of concern.

A detailed summary of the influent and effluent screening step is shown below in **Table 3** and **Table 4**, respectively.

Table 2: Screening of Organic Constituents in Biosolids

Constituent	TCLP limit, mg/L	Facility Inhibition (Anaerobic Digestion), mg/L	Sample Count	Number of Detected Samples	% Detects	Maximum Value			Pollutant of Concern?
						Qual	Value	Units	
1,2-Dichlorobenzene	-	0.23	20	12	60%	=	1.1	µg/kg	No, max value (1.1 µg/kg) is less than digestion inhibition criteria (230 µg/L) by a factor of 200
1,4-Dichlorobenzene	7.5	1.4	20	18	90%	=	17	µg/kg	No, max value (17 µg/kg) is less than digestion inhibition criteria (1,400 µg/L) by a factor of 80
Benzene	0.5	-	20	9	45%	DNQ	0.57	µg/kg	No, max value (0.57 µg/kg) is less than TCLP leachate limit (500 µg/L) by factor of 900
Chlorobenzene	100	0.96	20	14	70%	=	0.45	µg/kg	No, max value (0.45 µg/kg) is less than digestion inhibition criteria (960 µg/L) by a factor of 2,000

Table 3: Screening of Metals and Organic Constituents in Influent

Constituent	Lowest Criteria		Samples					Headworks Loading Analysis?	
	Value, µg/L	Reference	Sample Count	No. of Detected Samples	% Detects	Max Value	Unit	Yes/No	Reason
1,2-Dichlorobenzene	230	Inhibition of Anaerobic Digestion	20	1	5	0.06	µg/L	No	Single detect in 20 samples
1,3-Dichlorobenzene	400	Water Quality Criterion	20	1	5	0.06	µg/L	No	Single detect in 20 samples
1,4-Dichlorobenzene	5	Water Quality Criterion	20	2	10	0.29	µg/L	No	Max value < 50% of Lowest Criteria
2,4,6-Trichlorophenol	2.1	Water Quality Criterion	20	1	5	2.52	µg/L	No	Single detect in 20 samples
2,4-Dichlorophenol	93	Water Quality Criterion	20	1	5	0.19	µg/L	No	Single detect in 20 samples
2,4-Dinitrotoluene	0.11	Water Quality Criterion	20	1	5	4.08	µg/L	No	Single detect in 20 samples
2,6-Dinitrotoluene	No Criteria	-	20	1	5	2.97	µg/L	No	Single detect in 20 samples
2-Chlorophenol	120	Water Quality Criterion	20	1	5	0.18	µg/L	No	Single detect in 20 samples
2-Nitrophenol	No Criteria	-	20	1	5	2.97	µg/L	No	Single detect in 20 samples
3,3-Dichlorobenzidine	0.04	Water Quality Criterion	20	1	5	5.91	µg/L	No	Single detect in 20 samples
4,4-DDT	0.00059	Water Quality Criterion	20	1	5	0.0248	µg/L	No	Single detect in 20 samples
4-Chloro-3-methylphenol	No Criteria	-	20	1	5	0.41	µg/L	No	Single detect in 20 samples
4-Nitrophenol	No Criteria	-	20	1	5	3.36	µg/L	No	Single detect in 20 samples
Antimony, Total Recoverable	6	Water Quality Criterion	20	20	100	0.88	µg/L	No	Max value < 50% of Lowest Criteria
Arsenic, Total Recoverable	10	Primary MCL	20	20	100	2.6	µg/L	No	Max value < 50% of Lowest Criteria
Benzene	1	Water Quality Criterion	20	1	5	0.14	µg/L	No	Single detect in 20 samples
Benzidine	0.00012	Water Quality Criterion	20	3	15	17.9	µg/L	Yes	Max value > 50% of Lowest Criteria
Benzo(a)anthracene	0.0044	Water Quality Criterion	20	1	5	0.51	µg/L	No	Single detect in 20 samples
Benzo(a)pyrene	0.0044	Water Quality Criterion	20	1	5	7.75	µg/L	No	Single detect in 20 samples

Constituent	Lowest Criteria		Samples					Headworks Loading Analysis?	
	Value, µg/L	Reference	Sample Count	No. of Detected Samples	% Detects	Max Value	Unit	Yes/No	Reason
Benzo(b)fluoranthene	0.0044	Water Quality Criterion	20	1	5	5	µg/L	No	Single detect in 20 samples
Bis (2-Chloroethoxy) Methane	No Criteria	-	20	1	5	0.26	µg/L	No	Single detect in 20 samples
Bis (2-Chloroethyl) Ether	0.031	Water Quality Criterion	20	1	5	0.75	µg/L	No	Single detect in 20 samples
Bis (2-Ethylhexyl) Phthalate	1.8	Water Quality Criterion	20	11	55	17.7	µg/L	Yes	Max value > 50% of Lowest Criteria
Bromoform	4.3	Water Quality Criterion	20	2	10	0.15	µg/L	No	Max value < 50% of Lowest Criteria
Butylbenzyl Phthalate	3000	Water Quality Criterion	20	11	55	17.5	µg/L	No	Max value < 50% of Lowest Criteria
Cadmium, Total Recoverable	1.8	Water Quality Criterion	20	20	100	0.48	µg/L	No	Max value < 50% of Lowest Criteria
Chloroform	60	Fume Toxicity	20	20	100	7.38	µg/L	No	Max value < 50% of Lowest Criteria
Chromium, Total Recoverable	50	Primary MCL	20	20	100	4.6	µg/L	No	Max value < 50% of Lowest Criteria
Copper, Total Recoverable	6.7	Water Quality Criterion	20	20	100	58.8	µg/L	Yes	Max value > 50% of Lowest Criteria
Cyanide, Total (as CN)	5.2	Water Quality Criterion	20	11	55	5.7	µg/L	Yes	Max value > 50% of Lowest Criteria
Dibromochloromethane	0.4	Water Quality Criterion	20	19	95	0.29	µg/L	Yes	Max value > 50% of Lowest Criteria
Dichlorobromomethane	0.56	Water Quality Criterion	20	19	95	0.45	µg/L	Yes	Max value > 50% of Lowest Criteria
Diethyl Phthalate	23000	Water Quality Criterion	20	13	65	9.82	µg/L	No	Max value < 50% of Lowest Criteria
Di-n-butyl Phthalate	2700	Water Quality Criterion	20	6	30	13.9	µg/L	No	Max value < 50% of Lowest Criteria
Di-n-octyl Phthalate	No Criteria	-	20	4	20	17.1	µg/L	No	No Criteria
Endrin	0.036	Water Quality Criterion	20	1	5	0.0048	µg/L	No	Single detect in 20 samples
Ethylbenzene	300	Water Quality Criterion	20	18	90	0.97	µg/L	No	Max value < 50% of Lowest Criteria
Fluoranthene	300	Water Quality Criterion	20	1	5	4.78	µg/L	No	Single detect in 20 samples
Heptachlor	0.00021	Water Quality Criterion	20	1	5	0.0032	µg/L	No	Single detect in 20 samples

Constituent	Lowest Criteria		Samples					Headworks Loading Analysis?	
	Value, µg/L	Reference	Sample Count	No. of Detected Samples	% Detects	Max Value	Unit	Yes/No	Reason
Isophorone	8.4	Water Quality Criterion	20	1	5	0.82	µg/L	No	Single detect in 20 samples
Lead, Total Recoverable	1.9	Water Quality Criterion	20	20	100	5.1	µg/L	Yes	Max value > 50% of Lowest Criteria
m,p-Xylenes	1750	Primary MCL	20	14	70	1.49	µg/L	No	Max value < 50% of Lowest Criteria
Mercury, Total	0.05	Water Quality Criterion	20	19	95	0.32	ng/L	No	Max value < 50% of Lowest Criteria
Methyl Tert-butyl Ether (MTBE)	5	Secondary MCL	20	1	5	0.05	µg/L	No	Single detect in 20 samples
Methylene Chloride	4.7	Water Quality Criterion	20	20	100	1.23	µg/L	No	Max value < 50% of Lowest Criteria
Nickel, Total Recoverable	37	Water Quality Criterion	20	20	100	8.2	µg/L	No	Max value < 50% of Lowest Criteria
Nitrobenzene	17	Water Quality Criterion	20	1	5	0.61	µg/L	No	Single detect in 20 samples
N-Nitrosodi-n-Propylamine	0.005	Water Quality Criterion	20	1	5	8.98	µg/L	No	Single detect in 20 samples
o-Xylene	1750	Title 22, Primary MCL	20	13	65	0.71	µg/L	No	Max value < 50% of Lowest Criteria
Phenol, Single Compound	21000	Water Quality Criterion	20	20	100	62	µg/L	No	Max value < 50% of Lowest Criteria
Selenium, Total Recoverable	5	Water Quality Criterion	20	19	95	2	µg/L	No	Max value < 50% of Lowest Criteria
Silver, Total Recoverable	2.1	Water Quality Criterion	20	20	100	0.74	µg/L	No	Max value < 50% of Lowest Criteria
Tetrachloroethene	0.8	Water Quality Criterion	20	8	40	0.18	µg/L	No	Max value < 50% of Lowest Criteria
Toluene	150	Water Quality Criterion	20	20	100	3.83	µg/L	No	Max value < 50% of Lowest Criteria
Trichloroethene	2.7	Water Quality Criterion	20	1	5	0.1	µg/L	No	Single detect in 20 samples
Zinc, Total Recoverable	86	Water Quality Criterion	20	20	100	210	µg/L	Yes	Max value > 50% of Lowest Criteria

Table 4: Screening of Metals and Organic Constituents in Effluent

Constituent	Lowest Criteria		Samples					Headworks Loading Analysis?	
	Value, µg/L	Reference	Sample Count	No. of Detected Samples	% Detects	Max Value	Unit	Yes/No	Reason
2,4,6-Trichlorophenol	2.1	Water Quality Criterion	20	3	15	0.72	µg/L	No	Max value < 50% of Lowest Criteria
4,4-DDD	0.00083	Water Quality Criterion	20	1	5	0.0026	µg/L	No	Single detect in 20 samples
Ammonia, Total (as N)	400,000	Inhibition of Activated Sludge	35	5	14	4.2	mg/L	No	Max value < 50% of Lowest Criteria
Antimony, Total Recoverable	6	Water Quality Criterion	20	20	100	0.52	µg/L	No	Max value < 50% of Lowest Criteria
Arsenic, Total Recoverable	10	Primary MCL	20	20	100	3.2	µg/L	No	Max value < 50% of Lowest Criteria
Bis (2-Ethylhexyl) Phthalate	1.8	Water Quality Criterion	21	13	62	3.69	µg/L	Yes	Max value > 50% of Lowest Criteria
Boron, Total	2,000	Geysers Standards	34	34	100	0.5	mg/L	No	Max value < 50% of Lowest Criteria
Butylbenzyl Phthalate	3,000	Water Quality Criterion	20	6	30	1.13	µg/L	No	Max value < 50% of Lowest Criteria
Cadmium, Total Recoverable	1.8	Water Quality Criterion	20	1	5	0.048	µg/L	No	Single detect out of 20 samples
Chloride	250,000	Secondary MCL	34	34	100	128	mg/L	Yes	Max value > 50% of Lowest Criteria
Chloroform	60	Fume Toxicity	20	20	100	9.35	µg/L	No	Max value < 50% of Lowest Criteria
Chromium, Total Recoverable	50	Primary MCL	20	20	100	1.3	µg/L	No	Max value < 50% of Lowest Criteria
Copper, Total Recoverable	6.7	Water Quality Criterion	20	20	100	6	µg/L	Yes	Max value > 50% of Lowest Criteria
Cyanide, Total (as CN)	5.2	Water Quality Criterion	20	11	55	1.9	µg/L	No	Max value < 50% of Lowest Criteria
Dibromochloromethane	0.4	Water Quality Criterion	20	18	90	0.46	µg/L	Yes	Max value > 50% of Lowest Criteria
Dichlorobromomethane	0.56	Water Quality Criterion	20	19	95	2.17	µg/L	Yes	Max value > 50% of Lowest Criteria
Diethyl Phthalate	23,000	Water Quality Criterion	20	5	25	3.35	µg/L	No	Max value < 50% of Lowest Criteria
Di-n-butyl Phthalate	2,700	Water Quality Criterion	21	5	24	1.48	µg/L	No	Max value < 50% of Lowest Criteria

Constituent	Lowest Criteria		Samples					Headworks Loading Analysis?	
	Value, µg/L	Reference	Sample Count	No. of Detected Samples	% Detects	Max Value	Unit	Yes/No	Reason
Lead, Total Recoverable	1.9	Water Quality Criterion	20	8	40	0.51	µg/L	No	Max value < 50% of Lowest Criteria
Mercury, Total	0.05	Water Quality Criterion	20	20	100	2.38	ng/L	No	Max value < 50% of Lowest Criteria
Methylene Chloride	4.7	Water Quality Criterion	20	1	5	0.32	µg/L	No	Single detect out of 20 samples
Nickel, Total Recoverable	37	Water Quality Criterion	20	20	100	7.9	µg/L	No	Max value < 50% of Lowest Criteria
Nitrate, Total (as N)	10,000	Primary MCL	35	35	100	28.6	mg/L	Yes	Max value > 50% of Lowest Criteria
Nitrite, Total (as N)	1,000	Primary MCL	34	34	100	3.2	mg/L	Yes	Max value > 50% of Lowest Criteria
Nitrate+Nitrite (as N)	10,000	Primary MCL	34	35	103	28.76	mg/L	Yes	Max value > 50% of Lowest Criteria
Nitrogen, Total Organic (as N)	No Criteria	-	34	29	85	2.7	mg/L	No	No Criteria
Phenol, Single Compound	21,000	Water Quality Criterion	21	8	38	0.55	µg/L	No	Max value < 50% of Lowest Criteria
Phosphorus, Total (as P)	No Criteria	-	1	1	100	3	mg/L	No	No Criteria
Selenium, Total Recoverable	5	Water Quality Criterion	20	8	40	0.78	µg/L	No	Max value < 50% of Lowest Criteria
Silver, Total Recoverable	2.1	Water Quality Criterion	20	2	10	0.23	µg/L	No	Max value < 50% of Lowest Criteria
Sodium, Total	100,000	Geysers Standards	34	34	100	113	mg/L	Yes	Max value > 50% of Lowest Criteria
Toluene	150	Water Quality Criterion	20	20	100	0.32	µg/L	No	Max value < 50% of Lowest Criteria
Total Dissolved Solids (TDS)	500,000	Secondary MCL	35	35	100	580	mg/L	Yes	Max value > 50% of Lowest Criteria
Zinc, Total Recoverable	86	Water Quality Criterion	20	20	100	50.2	µg/L	Yes	Max value > 50% of Lowest Criteria

3.4.3 Pollutants of Concern Analyzed for Maximum Allowable Headworks Loading

The final list of Pollutants of Concern for which MAHLs were developed is shown in **Table 5** below.

Table 5: Pollutants of Concern

Parameter	Primary Reason for Including as Pollutant of Concern	Category
Antimony	Existing Local Limit	Metal
Arsenic	Existing Local Limit	Metal
Beryllium	Existing Local Limit	Metal
Cadmium	Existing Local Limit	Metal
Chromium	Existing Local Limit	Metal
Copper	Existing Local Limit	Metal
Cyanide	Existing Local Limit	Metal
Lead	Existing Local Limit	Metal
Mercury	Existing Local Limit	Metal
Nickel	Existing Local Limit	Metal
Selenium	Existing Local Limit	Metal
Silver	Existing Local Limit	Metal
Thallium	Existing Local Limit	Metal
Zinc	Existing Local Limit	Metal
Benzidine	Detected in influent at concentration above 50% of lowest criterion	Organic
Bis (2-Ethylhexyl) Phthalate	Detected in influent and effluent at concentration above 50% of lowest criterion	Organic
Dibromochloromethane	Detected in influent and effluent at concentration above 50% of lowest criterion	Organic
Dichlorobromomethane	Detected in influent and effluent at concentration above 50% of lowest criterion	Organic
Total Dissolved Solids (TDS)	Existing Local Limit	Salt
Chloride	Detected in effluent at concentration above 50% of lowest criterion	Salt
Sodium, Total	Detected in effluent at concentration above 50% of lowest criterion	Salt
BOD	Existing Local Limit	Conventional
TSS	Existing Local Limit	Conventional
TKN	Existing Local Limit	Conventional

Chapter 4 Maximum Allowable Headworks Loadings

This chapter presents the calculations associated with determining Maximum Allowable Headworks Loadings (MAHLs) for the pollutants of concern listed in **Table 5**. A MAHL is an estimate of the upper limit of pollutant loading to the Facility intended to prevent pass through or interference and meet all Facility requirements. The MAHL is calculated in three steps:

- Calculate Facility removal efficiency for each pollutant of concern.
- Calculate allowable headworks loadings (AHLs) for each environmental criterion. The major criteria considered here include Facility capacity, effluent limitations, water quality criteria, biosolids disposal criteria, and Facility interference.
- Designate the most stringent AHL for each pollutant of concern as the MAHL.

4.1 Data Used in Headworks Loading Analysis

Monitoring data collected by the City over the 2011-2016 period and described above in **Section 3.3** were used to conduct the headworks loading analysis and subsequent calculations of local limits. Influent concentrations were converted to mass loadings using the average flow rate through the Facilities during this time. Flow rates used were as follows:

- Average total flow rate through the Facility: 17.5 MGD
- Average flow rate from permitted industrial and groundwater dischargers: 0.252 MGD. The contribution from industrial dischargers is 0.24 MGD, while the contribution from groundwater dischargers is 0.012 MGD.
- Calculated flow from “uncontrollable” dischargers = $17.5 \text{ MGD} - 0.252 \text{ MGD} = 17.25 \text{ MGD}$. Loading from domestic and commercial sources is considered “uncontrollable” per USEPA Local Limits Guidance, because these users do not hold discharge permits and are not individually monitored.

The following sampling locations were used to estimate removal efficiency and influent loading:

- INF-001 (formerly M-INF): untreated influent wastewater collected at the plant headworks, preceding primary treatment
- EFF-001 (formerly M-001): treated wastewater prior to storage or discharge to the reclamation system or surface waters

Sample results reported for EFF-012B (formerly M-005) were excluded from the effluent wastewater analysis, as this monitoring station is representative of water stored in Delta Pond, rather than final effluent.

4.1.1 Identification of Outliers in the Data Set

Influent and effluent concentration data were assessed to determine if any of the data points should be considered outliers, using criteria suggested by USEPA’s Local Limits Guidance. The interquartile method was used, wherein any data point more than 1.5 times the interquartile range above the 3rd quartile or below the 1st quartile was considered an outlier. Best professional judgment was used to include data points in each set that would have been considered outliers when most of the data set comprised of non-detects ND, or estimated DNQ values, which provided additional conservatism in the analysis. As such, outliers were only considered for cyanide and bis (2-ethylhexyl) phthalate.

Plots of pollutant concentrations for all pollutants of concern analyzed are presented in **Appendix B**.

4.1.2 Concentrations below the Minimum Quantification Level

To be conservative, constituents that were not detected (ND) in influent or effluent were averaged at the method detection limit (MDL). For calculations regarding removal efficiency and influent load,

concentrations flagged as “Detected but not quantified” (DNQ) or “Estimated” were included using the estimated value.

4.1.3 Data Trends

In assessing whether new or revised local limits were needed for each pollutant, the loading was reviewed to determine if there were any substantial changes over time. No obvious, consistent trend is evident during the re-evaluation period. Plots of the pollutants flagged as pollutants of concern and requiring a headworks loading analysis are shown in **Appendix B**.

4.2 Removal Efficiencies

The estimates of removal efficiency applied in the MAHL calculations were based on influent and effluent data. Influent and effluent data were used rather than influent and biosolids data because this allows the use of paired data to calculate removal efficiency. The calculation of removal efficiency from the headworks to Facility effluent uses the following equation:

$$\text{Paired, Daily Removal Efficiency} = \frac{\text{INF Concentration} - \text{EFF Concentration}}{\text{INF Concentration}}$$

Removal efficiencies were calculated for each constituent for each sampling event where influent and effluent samples were collected on the same day. The final removal efficiency for constituents' MAHL calculations are based on a median of the daily removal efficiencies calculated throughout the five-year data period. Daily removal efficiencies were not considered where outliers were flagged in a dataset to minimize bias from outlier concentrations, and selecting the median removal efficiency also minimizes bias from outlier removal efficiencies.

Removal efficiencies were assumed to be 0% for beryllium and thallium because they were not detected in either the influent or effluent. A removal efficiency of 0% was also assumed for dissolved salts (TDS, chloride, sodium); although no influent monitoring data were available, these constituents are not typically removed by Facility processes. For these constituents, the influent concentrations were assumed to be at the same levels as the respective effluent concentrations. Additionally, the calculated removal efficiency for dichlorobromomethane is negative due to higher concentrations in the effluent compared to the influent, which suggests production within the treatment plant. For the headworks loadings calculations, this constituent's removal efficiency was also assumed to be zero.

The removal efficiency for total nitrogen assumes that all influent total nitrogen is present as TKN (ammonia plus organic nitrogen), which is typical of municipal wastewater. Effluent total nitrogen was calculated as the sum of nitrate, nitrite, ammonia, and organic nitrogen.

Removal efficiencies for all pollutants of concern are shown below in **Table 6**. Removal efficiencies were also calculated based on the mean and median concentrations for each constituent; the results are typically about the same as the median paired daily removal efficiency. These results are also shown in **Table 6**. Only the removal efficiency calculated using the median of daily pairs was used going forward (i.e., the last column in **Table 6**).

Table 6: Removal Efficiencies for Pollutants of Concern

Constituent	Influent Concentration (µg/L)		Effluent Concentration (µg/L)		Removal Efficiency		
	Average	Maximum	Average	Maximum	Mean	Median	Median of Daily Pairs
Antimony	0.63	0.88	0.39	0.52	38%	43%	36%
Arsenic	2	2.6	1.39	1.9	31%	30%	31%
Beryllium	0.093	0.12	0.093	0.12	0%	0%	0%
Cadmium	0.22	0.48	0.078	0.13	65%	65%	63%
Chromium	3.3	4.6	0.56	1	83%	84%	84%
Copper	40.9	58.8	3.1	6	92%	93%	92%
Cyanide	1.6	3.5	1.3	1.9	19%	0%	20%
Lead	2.5	5.1	0.33	0.51	87%	86%	83%
Mercury	0.1	0.32	0.00155	0.00238	98%	98%	98%
Nickel	6.2	8.2	3.2	7.1	48%	52%	50%
Selenium	1.04	2	0.52	0.78	50%	45%	52%
Silver	0.42	0.74	0.082	0.23	80%	78%	79%
Thallium	0.22	0.32	0.22	0.32	0%	0%	0%
Zinc	160	210	36.3	50.2	77%	78%	78%
Benzidine	8	18	1	1	88%	90%	93%
Bis (2-Ethylhexyl) Phthalate	6.4	8.6	1.15	2	82%	85%	82%
Dibromochloromethane	0.19	0.29	0.16	0.46	16%	30%	43%
Dichlorobromomethane ¹	0.25	0.45	1.02	2.17	0%	0%	0%
Constituent	Influent Concentration (mg/L)		Effluent Concentration (mg/L)		Removal Efficiency		
	Average	Maximum	Average	Maximum	Mean	Median	Median of Daily Pairs
Total Dissolved Solids (TDS) ²	492	580	492	580	0%	0%	0%
Chloride ²	89	128	89	128	0%	0%	0%
Sodium ²	96	113	86	113	0%	0%	0%
BOD	369	670	2	15	99.5%	99.5%	99.6%
TSS	387	1,900	1	52	99.7%	99.7%	99.7%
Total Nitrogen ³	58	96	17	22	70%	68%	69%
Total Phosphorus	7.2	10	3.8	6	47%	47%	47%

¹ Concentration values resulted in a negative calculated removal efficiency. Removal efficiencies recorded as 0%.

² For salt constituents: Only effluent monitoring data are available. Influent concentrations assumed to be the same as effluent, and thus, removal efficiencies are assumed to be 0%.

³ Influent total nitrogen is taken from average monthly influent TKN monitoring. Effluent total nitrogen is the sum of average monthly nitrate, nitrite, ammonia, and organic nitrogen.

4.3 Allowable Headworks Loadings

This section contains calculations of allowable headworks loadings (AHLs) based on a variety of criteria such as design capacity for conventional pollutants, NPDES permit limits, biosolids land application limits, Facility interference, and other considerations. The lowest, and therefore most stringent, of these calculated AHLs is the MAHL for a given pollutant.

4.3.1 Facility Design Capacity for Conventional Pollutants

The Facility design capacity for BOD, TSS, and TKN were estimated in the City's most recent local limits update, which focused exclusively on these conventional pollutants (CH2MHill, 2000). A similar approach was used where possible, to maintain consistency with the City's existing technically-based local limits for these pollutants.

BOD

In the 2000 local limits update, the AHL for BOD was estimated based on the allowable solids loading to the secondary clarifiers and an assumption of 25% BOD removal during primary treatment. No significant changes have been made to the Facility to alter this capacity, so the same estimate of 111,100 lb/day was used in this analysis.

TSS

The 2000 local limits update estimated the AHL for TSS based on the NPDES effluent limit (10 mg/L), the rated average dry weather flow capacity of the plant (19.2 MGD in 2000; 21.34 MGD now) and a conservative estimate of 2% pass-through (i.e., 98% removal). Actual removal through the plant exceeds this standard about 99.9% of the time, based on influent and effluent monitoring data collected daily from November 2011 to October 2016. Therefore, this approach is more conservative than using a median or mean removal efficiency. The AHL was updated to reflect the current dry weather flow capacity, as follows:

$$\text{AHL} = (8.345) \cdot (\text{Average Dry Weather Flow, MGD}) \cdot (\text{Effluent Limitation, mg/L}) / (1 - \text{Removal Efficiency})$$

$$\text{AHL} = (8.345) \cdot (21.34 \text{ MGD}) \cdot (10 \text{ mg/L}) / (1 - 0.98) = 89,000 \text{ lb/day}$$

Total Kjeldahl Nitrogen

The 2000 local limits update estimated the AHL for TKN based on aeration capacity, which is used to support both BOD removal and nitrification. The AHL was calculated by subtracting actual BOD loading from the aeration capacity of the Facility. For this update, the actual BOD loading was updated from the value assumed in 2000 (46,933 lb/day) to the average BOD loading over the period November 2011 to October 2016, which was 51,500 lb/day.

$$\text{AHL} = (\text{Aeration Capacity} - \text{BOD O}_2 \text{ demand}) / (4.57 \text{ lb O}_2 / \text{lb TKN removed})$$

$$\text{AHL} = (160,258 \text{ lb O}_2 / \text{day} - 51,500 \text{ lb BOD/day} * 1.1 \text{ lb O}_2 / \text{lb BOD}) / (4.57 \text{ lb O}_2 / \text{lb TKN removed}) = 22,700 \text{ lb/day}$$

The updated estimates of Facility capacity are shown below in **Table 7**.

Table 7: Facility Design Capacity for BOD, TSS, and TKN

Constituent	AHL based on Facility Design Capacity, lb/day
BOD	111,000
TSS	89,000
TKN	22,700

Although the estimated design capacities above were used as MAHLs, the section below also includes AHLs based on the NPDES permit limits and actual removal rates to confirm that the design capacities produce the more conservative AHLs.

4.3.2 Water Quality Thresholds

AHLs based on water quality thresholds were calculated using Equation 5.5 from the Local Limits Guidance, as follows:

$$\text{AHL} = \frac{(8.345) \cdot (\text{Water Quality Threshold, mg/L}) \cdot (\text{POTW average flow rate, MGD})}{(1 - \text{Removal Efficiency})}$$

The Permit contains effluent limits for dibromochloromethane and dichlorobromomethane. Each of these effluent limits is exactly equal to lowest applicable water quality criterion also identified in the Reasonable Potential Analysis (RPA) summarized in Table F-13 of the Permit.

The City may discharge to Santa Rosa Creek and/or the Laguna de Santa Rosa, which support the municipal and domestic supply beneficial use per the *Water Quality Control Plan for the North Coast Region* (Basin Plan). As such, EPA's National Drinking Water Regulations were considered, both primary and secondary MCLs. Primary and secondary MCLs in Title 22 of the California Code of Regulations, Section 64431 (Inorganic Chemicals), Section 64444 (Organic Chemicals), and Section 64439 (Secondary MCLs) were also considered. In most cases, these MCLs are already listed in Table F-14 of the Permit, except for arsenic (now 10 µg/L instead of the 50 µg/L listed in the Permit due to a rule update), and chromium (developed for total chromium for this analysis, but separately for Chromium-III and Chromium-VI as in the Permit). AHLs calculated using the methods described above are shown in **Table 8**.

For TDS, the City's current local limit was established based on a water quality threshold of 640 mg/L for irrigation of grapes with recycled water (1,000 µS/cm per Ayers and Westcot, 1989). This is identical to the Geysers recharge standard of 640 mg/L listed below in **Table 8**. These water quality standards were used to develop the AHL for TDS in **Table 8**, even though the recommended secondary MCL of 500 mg/L is lower. This approach is consistent with the development of the current local limit, and does not pose a threat to drinking water quality. The Permit limits the Plant discharge flow to a maximum 5 percent of the instantaneous flow of the Russian River, which has a background concentration of approximately 200 mg/L (CH2MHill, 2000). At an effluent concentration of 1,000 mg/L TDS (the upper threshold secondary MCL) the TDS concentration in the Russian River would increase by just 20% to 240 mg/L, which is still well below the recommended secondary MCL of 500 mg/L.

Table 8: AHLs Based on Water Quality Thresholds

Constituent	Water Quality Criteria, RPA	NPDES Permit	Geysers Recharge Standards	Federal Primary MCL	Federal Secondary MCL	Title 22, Primary MCL	Title 22, Secondary MCL	Lowest Criteria	AHL
	µg/L								µg/L
Antimony	6	-	-	6	-	6	-	6	1.4
Arsenic	50	-	30	10	-	10	-	10	2.1
Beryllium	4	-	-	-	-	-	-	4	0.58
Cadmium	1.8	-	5	5	-	5	-	1.8	0.71
Chromium	150	-	100	100	-	50	-	50	46.2
Copper	6.7	-	200	1,300	1,000	-	1,000	6.7	12.5
Cyanide	5.2	-	-	200	-	150	-	5.2	0.95
Lead	1.9	-	50	-	-	-	-	1.9	1.6
Mercury	0.05	-	2	2	-	2	-	0.05	0.37
Nickel	37	-	200	-	-	100	-	37	10.8
Selenium	5	-	50	50	-	50	-	5	1.5
Silver	2.1	-	-	-	100	-	100	2.1	1.5
Thallium	1.7	-	-	-	-	-	-	1.7	0.25
Zinc	86	-	100	-	5,000	-	5,000	86	55.9
Benzidine	0.00012	-	-	-	-	-	-	0.00012	0.00024
Bis (2-Ethylhexyl) Phthalate	1.8	-	-	-	-	-	-	1.8	1.5
Dibromochloromethane	0.4	0.4	-	-	-	-	-	0.4	0.10
Dichlorobromomethane	0.56	0.56	-	-	-	-	-	0.56	0.082
Constituent / Units	mg/L	mg/L	mg/L	mg/L	mg/L	mg/L	mg/L	mg/L	lb/day
TDS	-	-	640	-	500	-	-	640	93,000
Chloride	-	-	150	-	250	-	-	150	22,000
Sodium	-	-	150	-	-	-	-	150	22,000
BOD	-	10	15	-	-	-	-	10	332,600
TSS	-	10	10	-	-	-	-	10	525,700
Total Nitrogen	-	10.6	25 (NO ₃ -N)	-	-	10 (NO ₃ -N)	-	10	4,700

4.3.3 Treatment Plant Interference

AHLs for Facility interference are based on literature values found in Appendix G of the Local Limits Guidance. The criteria for inhibition are based on the literature values reported for activated sludge and anaerobic digester inhibition. These literature values are expected to be representative of the biological treatment process at the plant. Inhibition criteria for secondary treatment were converted to AHLs using Equation 5.10 in the Local Limits Guidance, as follows:

$$\text{AHL} = (8.345) \cdot (\text{Inhibition criterion for secondary treatment, mg/L}) \cdot (\text{POTW avg. flow rate, MGD})$$

To be conservative, no adjustment was made for removal in the primary treatment system.

Inhibition criteria for sludge digestion were converted to AHLs using Equation 5.12 in the Local Limits Guidance, as follows:

$$\text{AHL} = (8.345) \cdot (\text{Inhibition criterion for sludge digester, mg/L}) \cdot (\text{Digester avg. flow rate, MGD})$$

Removal Efficiency

AHLs for Facility interference calculated by the methods described above are shown below in **Table 9**.

Table 9: AHLs Based on Treatment Plant Interference

Constituent	Activated Sludge Inhibition		Anaerobic Digester Inhibition		Lowest AHL
	µg/L	lb/day	µg/L	lb/day	lb/day
Antimony	-	-	-	-	N/A
Arsenic	100	15	16,000	46	15
Beryllium	-	-	-	-	N/A
Cadmium	1,000	146	20,000	28	28
Chromium	1,000	146	130,000	137	137
Copper	1,000	146	40,000	38	38
Cyanide	100	15	1,000	4	4
Lead	1,000	146	340,000	363	146
Mercury	100	15	-	-	15
Nickel	1,000	146	10,000	18	18
Selenium	-	-	-	-	N/A
Silver	-	-	13,000	15	15
Thallium	-	-	-	-	N/A
Zinc	300	44	4,000,000	4,560	44
Benzidine	-	-	-	-	N/A
Bis (2-Ethylhexyl) Phthalate	-	-	-	-	N/A
Dibromochloromethane	-	-	-	-	N/A
Dichlorobromomethane	-	-	-	-	N/A
TDS	-	-	-	-	N/A
Chloride	-	-	-	-	N/A
Sodium	-	-	-	-	N/A
BOD	-	-	-	-	N/A
TSS	-	-	-	-	N/A
TKN	-	-	-	-	N/A

4.3.4 Explosivity, Fume Toxicity, Worker Exposure

None of the pollutants of concern had identified discharge screening levels for either explosivity or fume toxicity listed in Appendix I of the Local Limits Guidance, nor for Worker Exposure listed in Appendix J.

4.3.5 Surface Disposal

AHLs based on surface disposal criteria were calculated using the more stringent of the land application limits and the landfill disposal limits. Applicable limits for land application of biosolids are based on 40 CFR §503.13(b)(3) (*Standards for the Use or Disposal of Sewage Sludge, Land Application*). Applicable landfill disposal limits are based on California hazardous waste criteria from 22 CCR §66261.24(a)(2)(A), table II (*Characteristic of Toxicity, Total Threshold Limit Concentration Values*) as well as Toxicity Characteristic Leachate Procedure (TCLP) Limits from Appendix F of the Local Limits Guidance. These criteria were converted¹ to AHLs using an adaption of Equation 5.9 from the Local Limits Guidance, as follows:

$$\text{AHL} = \frac{(6.04 \times 10^{-6}) \cdot (\text{Biosolids Pollutant Criteria, mg/kg Dry Weight}) \cdot (\text{Dry Biosolids Production Rate, Metric tons/yr})}{\text{Removal Efficiency}}$$

Since the landfill disposal limits are expressed as wet weight, they were converted to dry weight limits assuming 15.1% solids, the average over the last 5 years. AHLs for surface disposal criteria calculated per the method described above are shown below in **Table 10**. Note that AHLs for beryllium and thallium were calculated assuming 100% removal, a conservative estimate since no removal efficiency could be estimated.

Table 10: AHLs based on Surface Disposal Criteria

Constituent	Land Application Limit		Landfill Disposal Limit		Lowest AHL
	mg/kg Dry Wt	lb/day	mg/kg Wet Wt	lb/day	lb/day
Antimony	-	-	500	207	207
Arsenic	41	3.0	500	243	3.0
Beryllium	-	-	75	11	11
Cadmium	39	1.4	100	24	1.4
Chromium	-	-	2,500	448	448
Copper	1,500	37	2,500	409	37
Cyanide	-	-	-	-	N/A
Lead	300	8.2	1,000	182	8.2
Mercury	17	0.4	20	3.1	0.4
Nickel	420	19.1	2,000	603	19.1
Selenium	100	4.4	100	29	4.4
Silver	-	-	500	95	95
Thallium	-	-	700	106	106
Zinc	2,800	82	5,000	973	82
Benzidine	-	-	-	-	N/A
Bis (2-Ethylhexyl) Phthalate	-	-	-	-	N/A
Dibromochloromethane	-	-	-	-	N/A

¹ The conversion factor 6.04×10^{-6} is derived from $[(2.205 \text{ lbs / kg})(1 \text{ kg}/1,000,000 \text{ mg}) (1000 \text{ kg /metric tons}) (1 \text{ yr} / 365 \text{ days})]$ and produces an AHL with units [lb/day] when used in the equation shown above.

Constituent	Land Application Limit		Landfill Disposal Limit		Lowest AHL
	mg/kg Dry Wt	lb/day	mg/kg Wet Wt	lb/day	lb/day
Dichlorobromomethane	-	-	-	-	N/A
TDS	-	-	-	-	N/A
Chloride	-	-	-	-	N/A
Sodium	-	-	-	-	N/A
BOD	-	-	-	-	N/A
TSS	-	-	-	-	N/A
TKN	-	-	-	-	N/A

4.3.6 Comparison of MAHLs to Actual Influent Loadings

Conventional Pollutants

AHLs for BOD and TSS are calculated in **Table 7** and **Table 8**. The lower of these AHLs, which are based on the rated design capacity of the Facility, are compared to the actual average and peak month influent loadings in **Table 11** below.

The MAHL for TKN is based on the rated design capacity of the Facility listed in **Table 7**. The AHLs for total nitrogen listed in **Table 8** are not applicable for use in developing a local limit for TKN because total nitrogen in Facility effluent is not representative of the total nitrogen content in surface water discharges².

Table 11: Maximum Allowable and Actual Influent Loadings for Conventional Pollutants

Constituent	MAHL	Avg Influent Loading	Max Month Influent Loading	Avg Influent Loading / MAHL
	lb/day	lb/day	lb/day	%
BOD	111,000	51,493	54,093	46%
TSS	89,000	54,619	75,564	61%
TKN	22,700	7,989	11,329	35%

For conventional pollutants, the Local Limits Guidance recommends that a revision to local limits should be considered when the monthly influent loading reaches 80 percent of the average design capacity. As **Table 11** indicates, none of the conventional pollutants currently exceeds 80 percent of design capacity on this basis.

Toxic Pollutants and Salts

The lowest of the AHLs listed above were used to establish the MAHLs for toxic pollutants, as shown in **Table 12**.

² The average total nitrogen content in effluent discharged to surface water is listed as 9.2 mg/L-N in the Permit (pg. F-32). The average total nitrogen content of all Facility effluent is 17 mg/L-N (Feb 2014 – Oct 2016).

Table 12: Comparison of AHLs Used to Determine the MAHL

Constituent	Water Quality Threshold AHL	Treatment Plant Interference AHL	Biosolids Disposal AHL	MAHL
	lb/day	lb/day	lb/day	lb/day
Antimony	1.4	-	207	1.4
Arsenic	2.1	15	3.0	2.1
Beryllium	0.58	-	11	0.58
Cadmium	0.71	28	1.4	0.71
Chromium	46.2	137	448	46.2
Copper	12.5	38	37	12.5
Cyanide	0.95	4	N/A	0.95
Lead	1.6	146	8.2	1.6
Mercury	0.37	15	0.4	0.37
Nickel	10.8	18	19.1	10.8
Selenium	1.5	-	4.4	1.5
Silver	1.5	15	95	1.5
Thallium	0.25	-	106	0.25
Zinc	55.9	44	82	44
Benzidine	0.00024	-	-	0.00024
Bis (2-Ethylhexyl) Phthalate	1.5	-	-	1.5
Dibromochloromethane	0.10	-	-	0.10
Dichlorobromomethane	0.082	-	-	0.082
TDS	93,000	-	-	93,000
Chloride	22,000	-	-	22,000
Sodium	22,000	-	-	22,000

The MAHL for each pollutant of concern is compared to actual average and maximum influent loadings in **Table 13** on the following page. The threshold used to determine whether local limits should be established is generally when the average influent loading exceeds 60% of the MAHL or when maximum influent loading exceeds 80% of the MAHL. Four constituents exceed this threshold, as shown in the table below: benzidine, bis (2-ethylhexyl phthalate), TDS, and chloride.

Table 13: Comparison of MAHLs and Actual Influent Loading for Toxic Pollutants and Salts

Constituent	MAHL	Avg Influent Loading	Max Influent Loading	Avg Influent Loading / MAHL	Max Influent Loading / MAHL
	lb/day	lb/day	lb/day	%	%
Antimony	1.4	0.09	0.13	7%	9%
Arsenic	2.1	0.29	0.38	14%	18%
Beryllium	0.58	0.01	0.02	2%	3%
Cadmium	0.71	0.03	0.07	4%	10%
Chromium	46.2	0.48	0.67	1%	1%
Copper	12.5	5.97	8.59	48%	69%
Cyanide	0.95	0.23	0.51	25%	54%
Lead	1.6	0.37	0.74	23%	46%
Mercury	0.37	0.01	0.05	4%	13%
Nickel	10.8	0.91	1.20	8%	11%
Selenium	1.5	0.15	0.29	10%	19%
Silver	1.5	0.06	0.11	4%	7%
Thallium	0.25	0.03	0.05	13%	19%
Zinc	44	23.37	30.67	53%	70%
Benzidine	0.00024	1.17	2.63	489000%	1100000%
Bis (2-Ethylhexyl) Phthalate	1.5	0.93	1.26	63%	85%
Dibromochloromethane	0.1	0.03	0.04	27%	41%
Dichlorobromomethane	0.082	0.04	0.07	45%	80%
TDS	93,000	72,000	85,000	77%	91%
Chloride	22,000	13,000	19,000	59%	85%
Sodium	22,000	13,000	17,000	57%	75%

A local limit for TDS is calculated and discussed in Chapter 6. The other three constituents were *not* considered for adoption of a local limit based on the following reasoning:

- Benzidine.** Benzidine is already listed as a prohibited substance in Santa Rosa City Code §15-08.070 (27)(a). The City considers non-detected or estimated results less than 10 µg/L as complying with this prohibition. Since it is not practical to set a local limit lower than this value due to detection limit considerations, no change to the existing local limit is needed.
- Bis (2-Ethylhexyl) Phthalate.** This constituent is a plasticizer frequently found in sampling and laboratory analysis equipment, and is a frequent sample contaminant both in the field and the laboratory. It is likely that some (though not all) of the estimated influent loading to the plant is reflective of sample contamination. It is not feasible to establish a local limit based on the available data, because the detection limit for uncontrollable source sampling (7.4 µg/L) is substantially higher than the water quality objective (1.8 µg/L). As a result, the estimated uncontrollable source loading is biased by high detection limits, and the calculated local limit would be zero. Bis (2-ethylhexyl) phthalate is already included in the list of TTOs for applicable categorical dischargers, and a separate local limit is not practical. The City will expend additional effort to reduce contamination in SIU effluent samples, which will improve the ability to distinguish real industrial sources from contaminated samples.

- **Chloride.** Current loading from TDS is closer to the MAHL (77% on average) than loading from chloride (59%). Since chloride is typically one of the primary components of salt, and TDS is the more limiting factor, it is logical to continue to implement a local limit for TDS rather than for chloride.

Chapter 5 Revised Local Limits

5.1 Calculation of Maximum Allowable Industrial Loading

This section includes a description of the calculation method, as well as results, for the Maximum Allowable Industrial Loading (MAIL) for each constituent.

- The Local Limits Guidance provides Equation 6.2 for calculating the MAIL, as shown below:

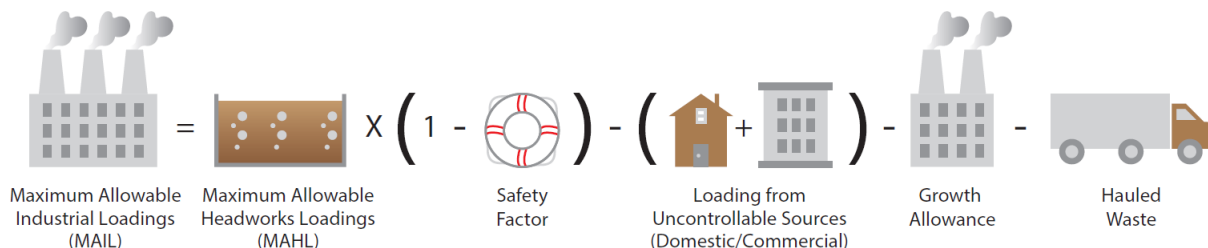

The EPA Local Limits Guidance generally recommends a minimum safety factor of 10%. Several different safety factors were used for three distinct groups of pollutants of concern³, as follows:

- Metals of Concern for Drinking Water – 40%:** The highest safety factor was used for eight metals that have federal or state primary MCLs, which indicate that these metals are a concern for drinking water: antimony, arsenic, cadmium, chromium, lead, mercury, nickel, and selenium. This approach is intended to protect drinking water supplies, including the groundwater basin.
- Other Metals and Cyanide – 20%:** A lower safety factor was used for cyanide, which attenuates in the environment, and for metals with no federal or state primary MCLs (beryllium, silver, thallium, and zinc). For copper, the drinking water objective found in the Lead and Copper Rule is more than 100 times larger than the aquatic life objective, so it was also not considered to be a metal of concern for drinking water.
- TDS – 5%.** A lower safety factor is used for TDS because the limit is not based on a regulatory standard, and the plant does not remove TDS (i.e., there is no uncertainty associated with the removal efficiency). The approach of using a lower safety factor for TDS is consistent with the approach used to develop the current local limit for TDS.

5.2 Uncontrollable Source Loading

The City monitors uncontrollable (domestic) dischargers as a group by sampling the collection system in areas where no industries are expected to be located upstream. There are a total of nine sampling sites: six are located in the City of Santa Rosa and one in each of the cities of Cotati, Rohnert Park and Sebastopol. Sampling is typically performed once a year for organic pollutants, and twice per year for metals, BOD, TKN and TSS. This local limits analysis used average concentrations from all nine sites for the period of 2012 - 2016.

Uncontrollable commercial source monitoring is not performed for BOD, TSS, TKN, or TDS. The uncontrollable source concentrations for these constituents were assumed to be equal to average influent concentrations.

The estimated average flow rate for uncontrollable sources (17.25 MGD) is based on the total plant flow rate (17.5 MGD) minus the average flow rate of permitted industrial and groundwater dischargers (0.252

³ The approach of using different safety factors for different constituents was vetted with USEPA staff (Pers. Comm. between Martin St. George and Amelia Whitson, September 2017).

MGD). A growth allowance of 8% was added to current uncontrollable source loading, which is approximately equal to the City’s currently projected annual growth rate of 0.8% for 10 years.

5.3 Trucked Waste

Under the City’s Trucked Waste program, the City receives hauled waste at a receiving station located at the Facility. In the one-year period from July 2016 through June 2017, the Facility received approximately four million gallons of hauled waste from domestic septic systems and chemical toilets, equivalent to an average septage flow rate of 0.011 MGD. The trucked waste program requires a Wastehauler Discharge Permit and payment of fees based on waste strength. Hauled septage waste is not subject to local limits.

As shown in the flow schematic in **Figure 3-1**, the hauled waste receiving station is located upstream of the raw influent sampling point. Similar to the approach used for “uncontrollable” domestic and commercial loading, the estimated septage loading was subtracted from the MAHL because it is not subject to local limits. To be conservative, this assessment sets aside 200% (i.e., double) of the estimated hauled septage waste loading in the MAIL calculation. Hauled waste metals concentrations from July 2016 through June 2017 are summarized in **Table 14** below. While the hauled wastes contain higher concentrations of pollutants compared to other uncontrollable sources, the loadings are generally low, as shown in the MAIL summary in the following section.

Table 14: Average Metals Concentration (July 2016 – June 2017)

Constituent	Concentration, µg/L	Constituent	Concentration, µg/L
Antimony	16	Mercury	18
Arsenic	134	Nickel	527
Beryllium	3.8	Selenium	23
Cadmium	22	Silver	63
Chromium	428	Thallium	10
Copper	10,614	Zinc	21,208
Lead	422		

Hauled waste concentrations for cyanide, BOD, TSS, TKN, and TDS were not available. For the purposes of the MAIL calculations, cyanide’s hauled waste concentration was assumed to be the same as that in the uncontrollable sources. Hauled waste loadings were not calculated for BOD, TSS, TKN, and TDS; loading of these constituents from septage was assumed to be negligible compared to the total Facility influent load.

5.4 Calculation of MAILs and Uniform Concentration Limits

This section includes calculation of the MAIL and conversion of this limit to a uniform concentration limits using the average industrial flow rate, including groundwater dischargers. As noted previously, the average industrial flow rate of 0.252 MGD is the sum of all permitted significant industrial users (including groundwater dischargers) over the period 2012-2016. This flow rate is applied using Equation 6.8 from the Local Limits Guidance, as shown below:

$$\text{Uniform concentration limit, mg/L} = \frac{\text{MAIL, lb/day}}{(\text{Total flow from industrial sources, MGD}) \cdot (8.345)}$$

The re-calculated MAIL and uniform concentration limits, as well as supporting information used in their development, are listed below in **Table 15**. Re-calculated local limits are presented below with one significant figure.

Table 15: MAILs and Re-Calculated Uniform Concentration Limits

Constituent	MAHL	Loading from Uncontrollable Sources		Hauled Waste (x2)	MAIL	Re-Calculated Local Limit	Current Local Limit	Recommendation for Revisions
	lb/day	Avg. Conc., µg/L	Loading, lb/day	lb/day	lb/day	mg/L	mg/L	
Antimony	1.38	0.55	0.08	0.0029	0.74	0.4	153	Remove
Arsenic	2.12	1.87	0.27	0.024	0.96	0.5	0.47	No Change
Beryllium	0.58	0.10	0.01	0.0007	0.45	0.2	0.5	Remove
Cadmium	0.71	0.23	0.033	0.0040	0.39	0.2	0.04	Increase
Chromium	46.2	2.00	0.29	0.078	5.16	2	1.71	No Change
Copper	12.50	34.3	4.94	1.93	2.73	1	0.2	Increase
Cyanide	0.95	2.21	0.32	0.0004	0.42	0.2	0.2	No Change
Lead	1.62	1.40	0.20	0.077	0.68	0.3	0.3	No Change
Mercury	0.37	0.06	0.009	0.0033	0.21	0.1	0.0003	No Change
Nickel	4.55	3.56	0.51	0.096	5.84	3	1.51	Increase
Selenium	1.51	1.12	0.16	0.0041	0.73	0.4	2.7	Remove
Silver	1.47	0.28	0.04	0.011	1.12	0.5	0.17	Increase
Thallium	0.25	0.25	0.04	0.0019	0.16	0.07	3.9	Remove
Zinc	43.8	170	24.5	3.9	4.69	2	1.63	Increase
Constituent / Units	lb/day	Avg. Conc., mg/L	Loading, lb/day	Hauled Waste, lb/day	MAIL, lb/day	Re-Calculated Local Limit, mg/L	Current Local Limit, mg/L	Recommendation for Revisions
TDS	93,000	492	70,824	N/A	12,300	5,800	5,200	No Change
BOD	111,000	369	53,180	N/A	31,370	14,900	20,400	Remove
TSS	89,000	387	55,700	N/A	11,040	5,300	9,800	Remove
TKN	22,700	58	8,280	N/A	9,220	4,400	2,600	Remove

The recommended revisions are grouped together by the recommended action and discussed below in greater detail.

5.4.1 Local Limit to Remain the Same

TDS

The re-calculated local limit for TDS (5,800 mg/L) is slightly higher than the current local limit (5,200 mg/L). The re-calculated local limit is based on the Geysers recharge standard of 640 mg/L, which is identical to the irrigation standard of 640 mg/L for grapes used to develop the current local limit. The City prefers to keep the TDS local limit the same as the existing limit, and will consider additional source control measures should TDS at the treatment plant become problematic.

Arsenic, Cyanide, Lead

After rounding, the re-calculated local limits for arsenic, cyanide, and lead are the same as the existing local limits. Therefore, no changes are proposed.

Mercury

The re-calculated local limit for mercury (0.1 mg/L) is considerably higher than the existing local limit (0.0003 mg/L). However, given that the Laguna de Santa Rosa is 303(d)-listed for mercury, the existing local limit should be retained to protect water quality.

Total Chromium

The City currently has a local limit for hexavalent chromium (Chromium VI) as well as total chromium. The re-calculated local limit for total chromium (2 mg/L), which includes chromium VI, is the same as the current local limit (1.71 mg/L) with rounding.

The re-calculated local limit was developed based on the Title 22 primary MCL for total chromium (50 µg/L). The recommended approach is also sufficiently stringent to meet the primary MCL for hexavalent chromium (10 µg/L), assuming the removal efficiency for hexavalent chromium is comparable to that for total chromium (84%). The recommended approach is to use the re-calculated local limit – which is the same as the existing limit after rounding – and remove the Chromium VI local limit.

5.4.2 Local Limits to be Increased to the Full Re-Calculated Value

Cadmium

The cadmium local limit is currently 0.04 mg/L. The local limit can be increased to the re-calculated value of 0.2 mg/L. Average influent loading is currently at approximately 4% of the MAHL, which is based on the most stringent water quality criterion of 1.8 µg/L.

Copper

The copper local limit is currently 0.2 mg/L. The local limit can be increased to the re-calculated value of 1 mg/L. Average influent loading is currently at approximately 48% of the MAHL, which is based on the most stringent water quality criterion of 6.7 µg/L.

Nickel

The nickel local limit is currently 1.51 mg/L. The local limit can be increased to the re-calculated value of 3 mg/L. Average influent loading is currently at approximately 8% of the MAHL, which is based on the most stringent water quality criterion of 37 µg/L.

Silver

The silver local limit is currently 0.17 mg/L. The local limit can be increased to the re-calculated value of 0.5 mg/L. Average influent loading is currently at approximately 4% of the MAHL, which is based on the most stringent water quality criterion of 2.1 µg/L.

Zinc

The zinc local limit is currently 1.63 mg/L. The local limit can be increased to the re-calculated value of 2 mg/L. Average influent loading is currently at approximately 53% of the MAHL, which is based on the most stringent water quality criterion of 86 µg/L.

5.4.3 Local Limits to be Removed

BOD, TSS, and TKN

The City currently controls BOD, TSS, and TKN using local limits **and** high-strength surcharges (\$/lb). The current rates are \$0.46/lb BOD, \$0.54/lb TSS, and \$1.17/lb TKN. Local limits for these constituents were first developed in 2000; prior to that, high-strength surcharges were in place for BOD, TSS, and ammonia (CH2MHill, 2000).

The re-calculated local limits are lower than current BOD and TSS limits and higher than current TKN limits – but in all cases, the re-calculated limits are so high that large, high-strength dischargers are more incentivized to implement pretreatment based on high-strength surcharges than by the local limits. Furthermore, the re-calculated local limits indicate sufficient capacity to treat high-strength waste. The City should remove these local limits and continue to implement high-strength surcharges where appropriate. This approach is consistent with many other dischargers in the region, including EBMUD, Union Sanitary District, Napa Sanitation District, Vallejo Sanitation & Flood Control District, Novato Sanitary District, and many others. The City should continue to re-evaluate the high-strength surcharge rate during wastewater rate studies, which are typically conducted once every five years (The Reed Group, 2015).

Antimony, Beryllium, and Thallium

These three constituents are not present in influent at a level that indicates a local limit is needed. Beryllium and thallium were not detected in any influent or effluent samples, and antimony loading is less than 10% of the MAHL. Furthermore, the current local limits for these constituents were not developed using site-specific removal data, which was not available due to the large number of non-detects in the data set (CH2MHill, 1990). This continues to be the case for beryllium and thallium, for which the removal efficiency was estimated at 0% due to the lack of any detected sample results. The City did not have a local limit for these constituents prior to 1990, and the rationale for adding them is not known, but does not appear to be technically based.

The current local limit for antimony (153 mg/L) is several orders of magnitude higher than the re-calculated local limit (0.48 mg/L). This may reflect the fact that the current drinking water standard for antimony (6 µg/L) became effective in 1994, after the current local limit was adopted in 1990.

Rather than adopt a more stringent limit for antimony, the City should remove this local limit, as neither the previous analysis in 1990 nor the current analysis established a need for a local limit based on influent loading.

Hexavalent Chromium

Please see discussion on Total Chromium above. The local limit for Total Chromium is sufficiently protective, so the local limit for hexavalent chromium can be removed.

Selenium

This constituent is not present at a level that indicates a local limit is needed. Influent loading is less than 20% of the MAHL, which is based on the water quality objective for aquatic life in freshwater. Furthermore, the current local limit was not developed using site-specific removal data (CH2MHill, 1990). Selenium is typically below detection levels in effluent, and rarely detected in biosolids (average value <15 mg/kg; land application ceiling criteria = 100 mg/kg). No significant industrial users have selenium

pretreatment systems, so removing the local limit is not likely to increase the headworks load. The City should remove this local limit.

5.5 Revisions to Non-Technically-Based Local Limits

The City's current local limits for pH, TTOs, TPH Gas and Diesel, Halogenated TTOs, and BTEX are not technically-based, but appear to be based upon best professional judgement at the time of adoption. As such, Maximum Allowable Industrial Loadings were not calculated for these constituents. This section provides recommendations for adjustments to these local limits.

pH

The City's current local limits specify that the pH must remain between 5.5 and 11.9. The local limit applies only to SIUs and is more stringent than the prohibition for all users, which requires the pH to fall between 5.0 and 12.0 (SRCC Code §15-08.070 (B) (2)). The City plans to standardize the pH limit so that the range of 5.0 to 12.0 is applicable to all users, including industrial users. A pH range of 5.0 to 12.0 for SIUs is acceptable per USEPA Local Limits Guidance, 40 CFR §403.5(b)(2) and 40 CFR §261.22(a)(1); wastes outside this range could be corrosive.

TTOs

The current local limit for TTOs is not technically-based. The screening of priority pollutants and Title 22 drinking water constituents conducted for this study included all the constituents listed in the City's definition of TTOs. This screening did not indicate that any specific organic pollutant needs to be controlled with a local limit. Therefore, on a technical basis, the TTO limit should be removed. City staff should continue to identify specific Best Management Practices for toxic organic pollutants within wastewater discharge permits, as described in City Code §15-08.340 (A)((3)). Best Management Practices identified this way are considered to be enforceable as local limits under the Pretreatment Streamlining Rule (USEPA, 2007).

TPH Gas and Diesel

The City currently has a local limit for TPH Gas and Diesel that applies to all SIUs. This local limit should be re-assigned to apply to groundwater dischargers only, as the City does not currently have any SIUs likely to discharge gas or diesel (e.g., Petroleum Refining or Centralized Waste Treatment).

For compliance determination with the local limit for TPH Gas and Diesel, the City will incorporate industry standard test methodologies to verify compliance. Depending on the site and pollutants of concern, EPA Solid Waste 846 methods or 40 CFR 136 methods will be specified in wastewater discharge permits for groundwater remediation dischargers.

Halogenated TTOs and BTEX

The local limits for halogenated TTOs and BTEX will apply to groundwater dischargers only. In the previous Local Limits Study performed for the City, the halogenated TTOs and BTEX limits were developed for both industrial users and groundwater remediation sites. Recent facility data indicates these local limits have been successful in their application to groundwater remediation sites. So, the basis for the continued use of local limits for halogenated TTOs and BTEX is Best Professional Judgement (BPJ) by City staff. City staff provided Woodard & Curran with an updated assessment of these groundwater-specific limits, and based on BPJ identified minor revisions to the list of halogenated organics as follows:

- a) Remove hexachlorobutadiene and hexachloroethane; and
- b) Define the sum of halogenated organics as the summation of all values observed at levels greater than 5 µg/L. Results less than 5 µg/L will not be included in the summation.

A complete list of constituents included in the definition of halogenated organics, and information about calculating the summation of quantifiable values, can be found in **Appendix C**.

Prohibited Substances

SRCC §15-08.070, Section B.27 contains a prohibition against the discharge of substances including specific pesticides (DDT, aldrin, heptachlor, and others), tetrachloroethene (“perc”), and PCBs. To assist with enforcement, the City plans to adopt a 5-µg/L detection limit as the threshold for determining whether the pollutant is present. This is the same threshold used for determining whether pollutants are included in the sum of Halogenated TTOs, as described above.

5.6 Summary of Proposed Revisions

A summary of the proposed revisions to the City’s current local limit is shown below in redline/strikeout form.

Table 16: Proposed Changes to Local Limits

Constituent	Local Limit (mg/L)
Antimony, Total	153
Arsenic, Total	0.47 0.5 (same with rounding)
Beryllium, Total	0.5
Biochem. Oxygen Demand (BOD)	20,400
Cadmium, Total	0.04 0.2
Chromium VI	0.1
Chromium, Total	1.74 2 (same with rounding)
Copper, Total	0.2 1
Cyanide, Total	0.2
Lead, Total	0.3
Mercury, Total	0.0003
Nickel, Total	1.54 3
Selenium, Total	2.7
Thallium, Total	3.9
Zinc, Total	1.63 2
pH	5.5-11.9 5.0- 12.0
Silver, Total	0.17 0.5
Total Toxic Organics (TTO)	2.13
Total Suspended Solids (TSS)	9,800
TPH Gas and Diesel <i>Groundwater remediation and cleanup projects only</i>	100
Total Dissolved Solids (TDS)	5,200
Total Kjeldahl Nitrogen (TKN)	2,600
Halogenated TTO <i>Groundwater remediation and cleanup projects only</i>	0.02 (See Appendix C for updated list of constituents)
BTEX <i>Groundwater remediation and cleanup projects only</i>	2

Several local limits are proposed to significantly increase: cadmium, copper, nickel, and silver. For these four constituents, the allowable industrial load will increase compared to the estimated load in the 1990 Local Limits study, as summarized below in **Table 17**. This does not mean that the *actual* industrial load will increase by the same amount, since most permitted SIUs discharge effluent that is far below the allowable local limits. However, some SIUs (i.e., metal finishers) will benefit from the increased local limits for these constituents, and the loading from an individual metal finisher may increase as a result.

Table 17: Estimated Changes in Allowable Industrial Loads

Constituent	Previously documented Industrial Load (Table 16 from 1990 Report), lb/day	Updated Estimate of Allowable Industrial Load, lb/day	Change
Antimony	600	Limit Removed	N/A
Arsenic	1.8	1.1	-42%
Beryllium	2	Limit Removed	N/A
Cadmium	0.16	0.4	+163%
Chromium	6.7	4.2	-37%
Copper	0.8	2.7	+242%
Cyanide	0.78	0.4	-46%
Lead	1.2	0.6	-47%
Mercury, Total	0.0012	0.0006	-47%
Nickel	5.9	6.3	+7%
Selenium	10.6	Limit Removed	N/A
Silver	0.24	1.1	+338%
Thallium	15.3	Limit Removed	N/A
Zinc	6.4	4.6	-28%

The proposed local limits for metals and TDS are compared to local limits of other POTWs in the region in **Table 18**, below. Local limits that are proposed to be removed or to significantly increase are highlighted in yellow. As indicated below, the Facility’s proposed limits are comparable to limits of other POTWs of similar size (7.5-25 MGD).

Table 18: Comparison of Proposed Local Limits with Other POTWs in the Region

Constituent	Santa Rosa - Current	Santa Rosa - Proposed	East Bay Municipal Utility District	City of Davis	Napa Sanitation District	Union Sanitary District	Dublin San Ramon Services District	Vallejo Flood & Wastewater District	Fairfield-Suisun Sewer District
Average Dry Weather Flow Capacity (MGD)									
	21.3	21.3	120	7.5	15.4	33	20.2	15.5	23.7
Local Limits, mg/L									
Antimony	153	No Limit	No Limit	No Limit	0.702	No Limit	No Limit	No Limit	No Limit
Arsenic	0.47	0.5	2	No Limit	0.025	0.35	0.5	0.04	0.1
Beryllium	0.5	No Limit	No Limit	No Limit	0.1	No Limit	No Limit	0.01	No Limit
Cadmium	0.04	0.2	1	0.1	0.016	0.2	1	0.02	0.05
Chromium	1.71	2	2	0.03	1.13	2	1	0.1	0.15
Copper	0.2	1	5	3	0.388	2	1	0.5	1.3
Cyanide	0.2	0.2	5	No Limit	0.03	0.65	0.5	0.1	0.7
Lead	0.3	0.3	2	1	0.102	1	2	0.5	0.5
Mercury	0.0003	0.0003	0.05	0.05	0.0057	0.01	0.01	0.005	0.01
Nickel	1.5	3	5	2	0.043	1	1.5	0.5	0.9
Selenium	2.7	No Limit	No Limit	0.01	0.026	No Limit	1.3	0.02	No Limit
Silver	0.17	0.5	1	2	0.224	0.5	1.5	0.75	0.2
Thallium	3.9	No Limit	No Limit	No Limit	0.999	No Limit	No Limit	No Limit	No Limit
TDS	5,200	5,200	No Limit	No Limit	836	No Limit	1,000	No Limit	No Limit
Zinc	1.63	2	5	1	0.762	No Limit	No Limit	1	2.3

The increase in allowable industrial loading is not expected to significantly impact the Facility's effluent quality, and is primarily a reflection of the following trends:

- Loading from residential and commercial sources has declined significantly as a result of corrosion control efforts (primarily, raising the pH of the drinking water supply), source control activities, and other changes. The concentration of copper has decreased from 230 µg/L to 34 µg/L, while the concentration of cadmium has decreased from < 10 µg/L (the detection limit) to 0.23 µg/L. The concentration of silver has decreased from 10 µg/L to 0.28 µg/L. Nickel data was not available. These load reductions have dramatically exceeded the estimated reductions listed in the 1990 Local Limits Study (CH2MHill, 1990).
- Detection limits for these metals have improved significantly since 1990, so total loading to the plant (either measured in total influent or in residential/commercial wastewater) is now known to be much lower compared to 1990. This allows a greater portion of plant capacity to be allocated to industry, rather than to uncontrollable sources. For example, for cadmium, the influent values measured in 1988-1990 were all 10 µg/L, which was the detection limit. The updated average influent concentration for cadmium is 0.22 µg/L.
- For silver, the water quality objective for silver is listed as 2.1 µg/L in the current NPDES permit – but the 1990 study assumed a water quality objective of 0.12 µg/L, while noting uncertainty about the value (CH2MHill, 1990).
- The Facility continues to demonstrate good removal of metals, meeting or exceeding the removal efficiencies reported in the 1990 Local Limits study.

References

- Ayers and Westcot. (1989). *Water Quality for Agriculture*. FAO Irrigation and Drainage Paper 29, Rev. 1. Rome, 1989. Available online at <http://www.fao.org/docrep/003/T0234E/T0234E00.htm>
- CH2MHill (1990). *Response to EPA Local Limits Review, Technical Memorandum No. P8*. Prepared for Santa Rosa Subregional Water Reclamation System, Industrial Waste Division. November 26, 1990. Updated December 9, 1991.
- CH2MHill (2000). *Development of Technically Based Local Limits for Conventional Pollutants*. Technical Memorandum prepared for Santa Rosa Subregional Water Reclamation System, Industrial Waste Division. June 20, 2000.
- Santa Rosa City Code, Title 15-08.100, *Sewer Use Regulations*.
- Office of Administrative Law (2004), *California Code of Regulations*, § 66261.24. Characteristic of Toxicity.
- Office of the Federal Register (2010), *Code of Federal Regulations (CFR)*, §413.02.
- North Coast Regional Water Quality Control Board (2013), Order Number R1-2013-0001 for the City of Santa Rosa, NPDES Permit No. CA0022764.
- The Reed Group, Inc. (2015), *Water and Wastewater Rate Study – Final Report*. Prepared for Santa Rosa Water. September 9, 2015.
- State Water Resources Control Board (1984), *Irrigation with Reclaimed Municipal Wastewater*. (Report No. 84-1 wr).
- United States Environmental Protection Agency (2003), Standards for the Use or Disposal of Sewage Sludge, *Code of Federal Regulations*, Part 503, Title 40.
- United States Environmental Protection Agency (2004), *Local Limits Development Guidance*. (EPA Publication No. 833-R-04-002A).
- United States Environmental Protection Agency (2007), *National Pretreatment Program – Pretreatment Streamlining Rule Fact Sheet 7.0: Best Management Practices*. (EPA Publication No. 833-F-06-013).

This page is intentionally left blank

Appendix A - Current Local Limits

**Table A-1: Summary of Current Local Limits
for the City of Santa Rosa**

Constituent	Current Local Limit (mg/L) ¹
Antimony	153
Arsenic	0.47
Beryllium	0.5
Biochem. Oxygen Demand (BOD)	20,400
Cadmium	0.04
Chromium VI	0.1
Chromium, Total	1.71
Copper	0.2
Cyanide	0.2
Lead	0.3
Mercury	0.0003
Nickel	1.51
Selenium	2.7
Thallium	3.9
Zinc	1.63
pH	5.5 – 11.9
Silver	0.17
Total Toxic Organics (TTO) ²	2.13
Total Suspended Solids (TSS)	9,800
TPH Gas and Diesel	100
Total Dissolved Solids (TDS)	5,200
Total Kjeldahl Nitrogen (TKN)	2,600
Halogenated TTO ³	0.02
BTEX ⁴	2.0

¹ Source: Santa Rosa Municipal Code, Title 15-08.100, “Local Limits”

² Federal Register List from 40 CFR 433.11(e) Listed TTOs. The term “TTO” shall mean total toxic organics, which is the summation of all quantifiable values greater than .01 milligrams per liter for the following toxic organics:

Acenaphthene, Acrolein, Acrylonitrile, Benzene, Carbon tetrachloride (tetrachloromethane), Chlorobenzene, 1,2,4-Trichlorobenzene, Hexachlorobenzene, 1,2,-Dichloroethane, 1,1,1-Trichloroethane, Hexachloroethane, 1,1-Dichloroethane, 1,1,2-Trichloroethane, 1,1,2,2-Tetrachloroethane, Chloroethane, Bis (2-chloroethyl) ether, 2-Chloroethyl vinyl ether (mixed), 2-Chloronaphthalene, 2,4,6-Trichlorophenol, Parachlorometa cresol, Chloroform (trichloromethane), 2-Chlorophenol, 1,2-Dichlorobenzene, 1,3-Dichlorobenzene, 1,4-Dichlorobenzene, 3,3-Dichlorobenzidine, 1,1-Dichloroethylene, 1,2-Trans-dichloroethylene, 2,4-Dichlorophenol, 1,2-Dichloropropane, 1,3-Dichloropropylene (1,3-dichloropropene), 2,4-Dimethylphenol, 2,4-Dinitrotoluene, 2,6-Dinitrotoluene, 1,2-Diphenylhydrazine, Ethylbenzene, Fluoranthene, 4-Chlorophenyl phenyl ether, 4-Bromophenyl phenyl ether, Bis (2-chloroisopropyl) ether, Bis (2-chloroethoxy) methane, Methylene chloride (dichloromethane), Methyl chloride (chloromethane), Methyl bromide (bromomethane), Bromoform (tribromomethane), Dichlorobromomethane, Chlorodibromomethane, Hexachlorobutadiene, Hexachlorocyclopentadiene, Isophorone, Naphthalene, Nitrobenzene, 2-Nitrophenol, 4-Nitrophenol, 2,4-Dinitrophenol, 4,6-Dinitro-o-cresol, N-nitrosodimethylamine, N-nitrosodiphenylamine, N-nitrosodi-n-propylamine, Pentachlorophenol, Phenol, Bis (2-ethylhexyl) phthalate, Butyl benzyl phthalate, Di-n-butyl phthalate, Di-n-octyl phthalate, Diethyl phthalate, Dimethyl phthalate, 1,2-Benzanthracene (benzo(a)anthracene), Benzo(a)pyrene (3,4-benzopyrene), 3,4-Benzofluoranthene

(benzo(b)fluoranthene), 11,12-Benzofluoranthene (benzo(k)fluoranthene), Acenaphthylene, Anthracene, 1,12-Benzoperylene (benzo(ghi)perylene), Fluorene, 1,2,5,6-Dibenzanthracene (dibenzo(a,h)anthracene), Indeno(1,2,3-cd)pyrene (2,3-o-phenylene pyrene), Pyrene, Toluene, Trichloroethylene, Vinyl chloride (chloroethylene)

³ Groundwater remediation and cleanup projects only. Halogenated TTO = Carbon tetrachloride (tetrachloromethane), Chlorobenzene, 1,2,4-Trichlorobenzene, Hexachlorobenzene, 1,2-Dichloroethane, 1,1,1-Trichloroethane, Hexachloroethane, 1,1-Dichloroethane, 1,1,2-Trichloroethane, 1,1,2,2-Tetrachloroethane, Chloroethane, Bis (2-chloroethyl) ether, 2-Chloroethyl vinyl ether (mixed), 2-Chloronaphthalene, 2,4,6-Trichlorophenol, Parachlorometa cresol (4-chloro-3-methylphenol), Chloroform (trichloromethane), 2-Chlorophenol, 1,2-Dichlorobenzene, 1,3-Dichlorobenzene, 1,4-Dichlorobenzene, 3,3-Dichlorobenzidine, 1,1-Dichloroethylene, 1,2-Trans-dichloroethylene, 2,4-Dichlorophenol, 1,2-Dichloropropane, 1,3-Dichloropropylene (cis 1,3-dichloropropene, trans 1,3 dichloropropene), Fluoranthene, 4-Chlorophenyl phenyl ether, 4-Bromophenyl phenyl ether, Bis (2-chloroisopropyl) ether, Bis (2-chloroethoxy) methane, Methylene chloride (dichloromethane), Methyl chloride (chloromethane), Methyl bromide (bromomethane), Bromoform (tribromomethane), Dichlorobromomethane, Chlorodibromomethane, Hexachlorobutadiene, Hexachlorocyclopentadiene, Pentachlorophenol, 3,4-Benzofluoranthene (benzo(b)fluoranthene), 11,12-Benzofluoranthene (benzo(k)fluoranthene), Fluorene, Trichloroethylene, Vinyl chloride (chloroethylene)

⁴ Groundwater remediation and cleanup projects only. BTEX = Benzene, Toluene, Ethylbenzene, Xylene

Appendix B - Plots of Facility Monitoring Data

Figure B-1: Antimony Concentration in Facility Influent

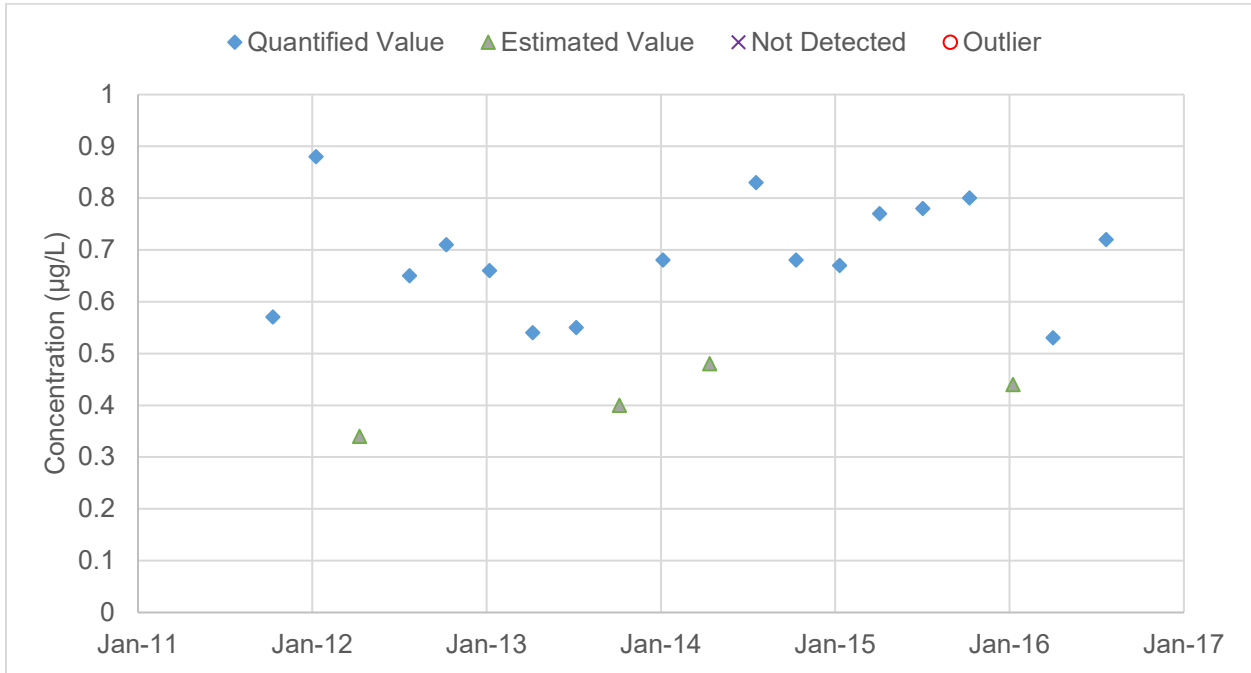

Figure B-2: Antimony Concentration in Facility Effluent

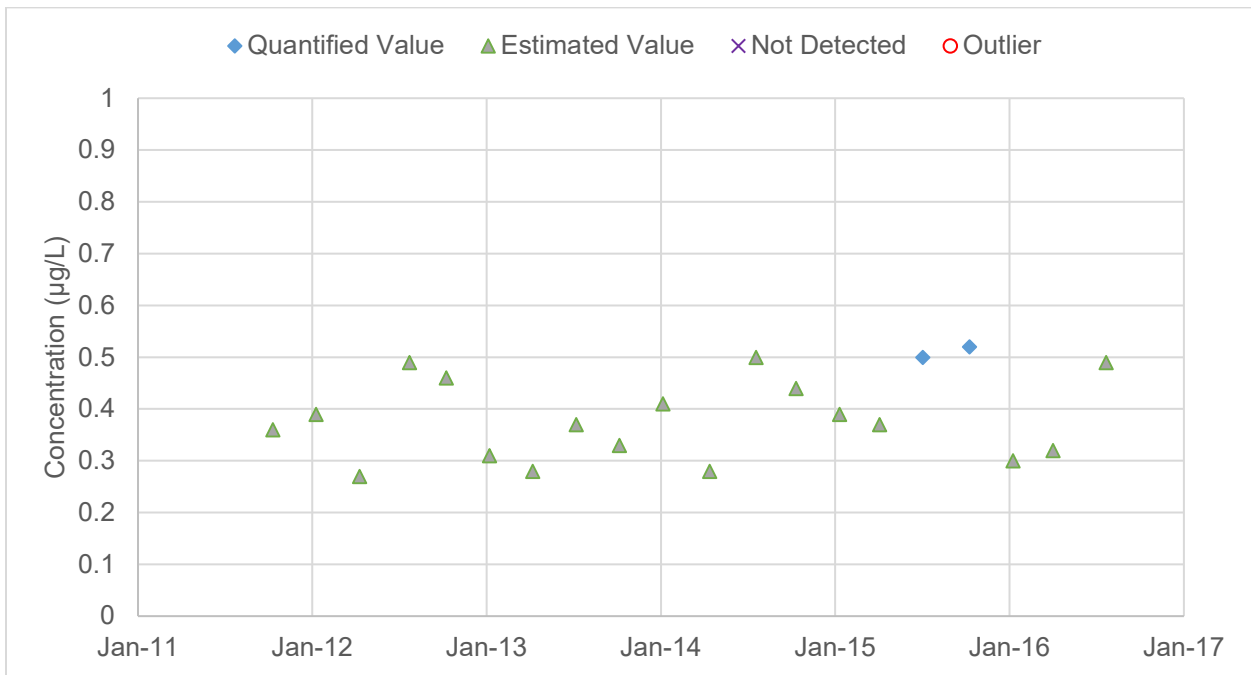

Figure B-3: Arsenic Concentration in Facility Influent

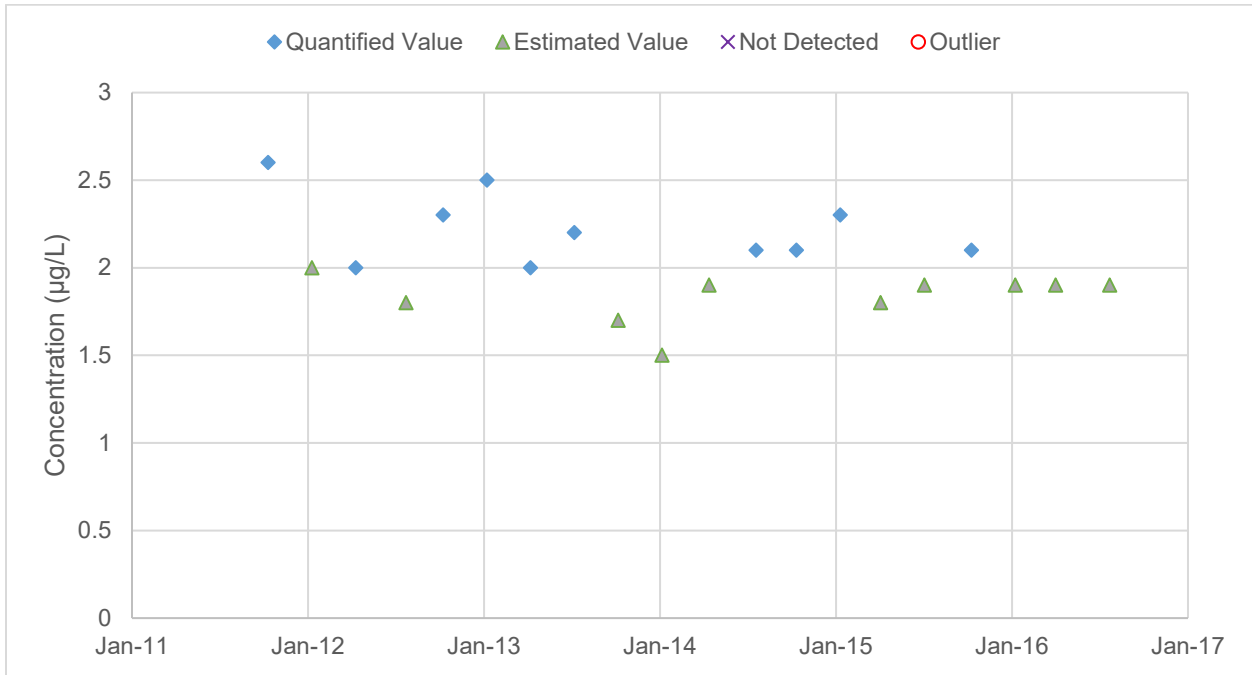

Figure B-4: Arsenic Concentration in Facility Effluent

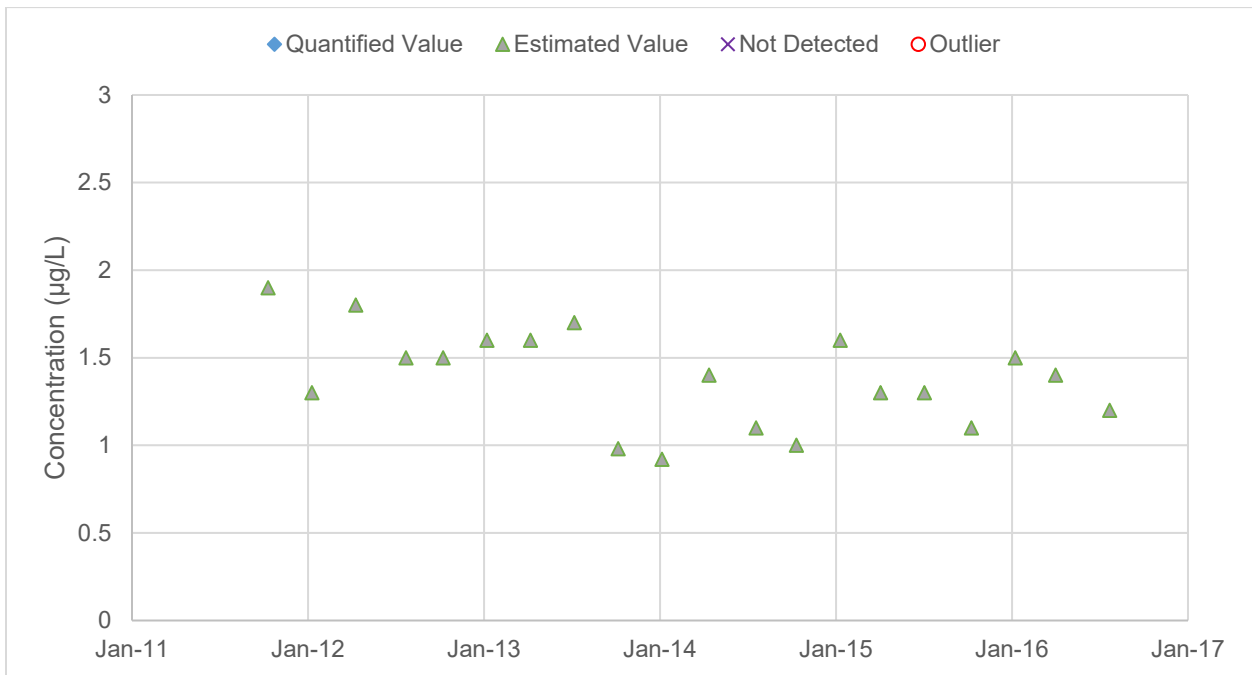

Figure B-5: Beryllium Concentration in Facility Influent

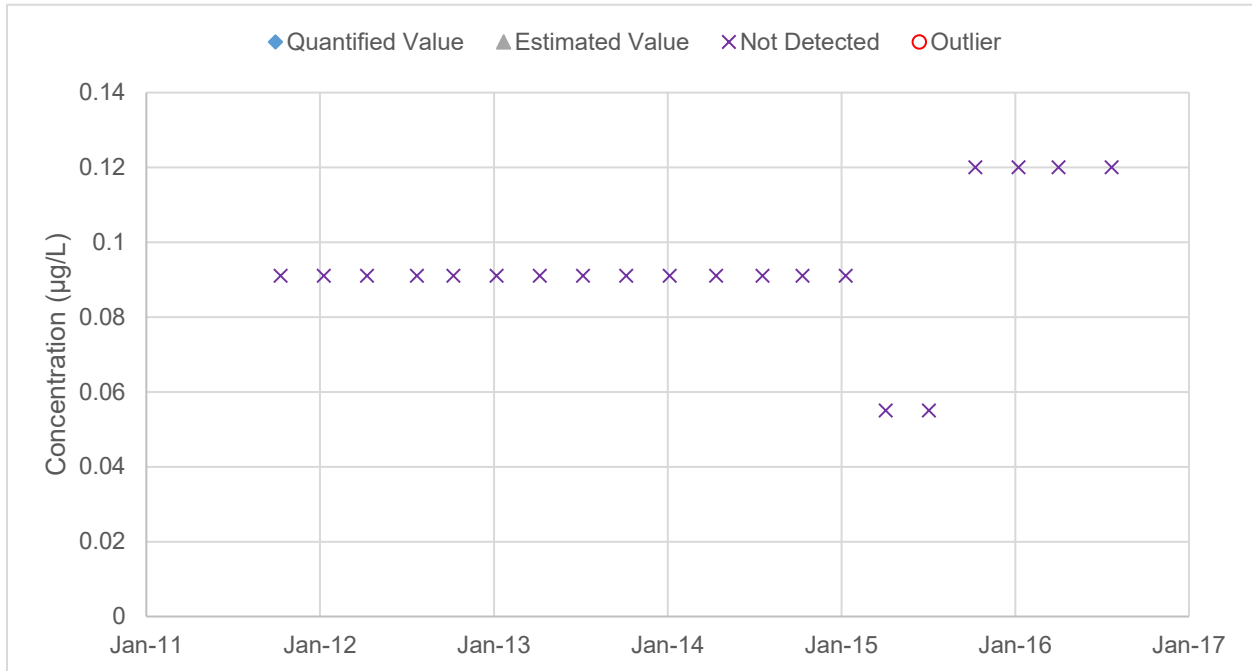

Figure B-6: Beryllium Concentration in Facility Effluent

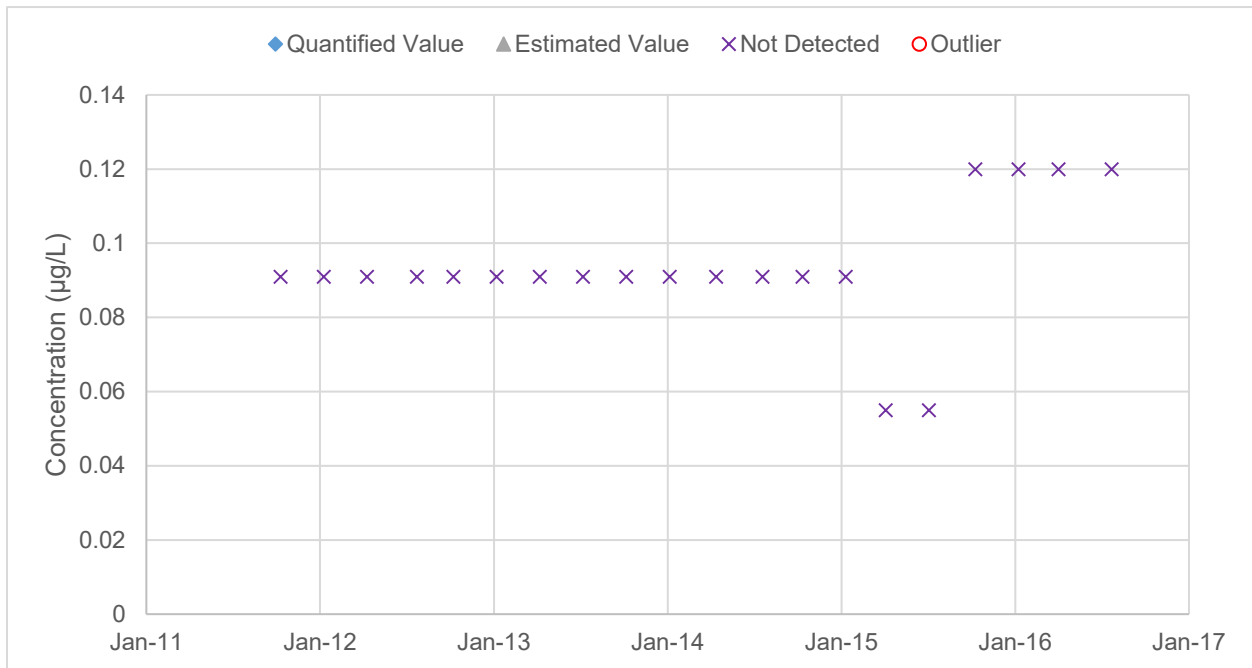

Figure B-7: Cadmium Concentration in Facility Influent

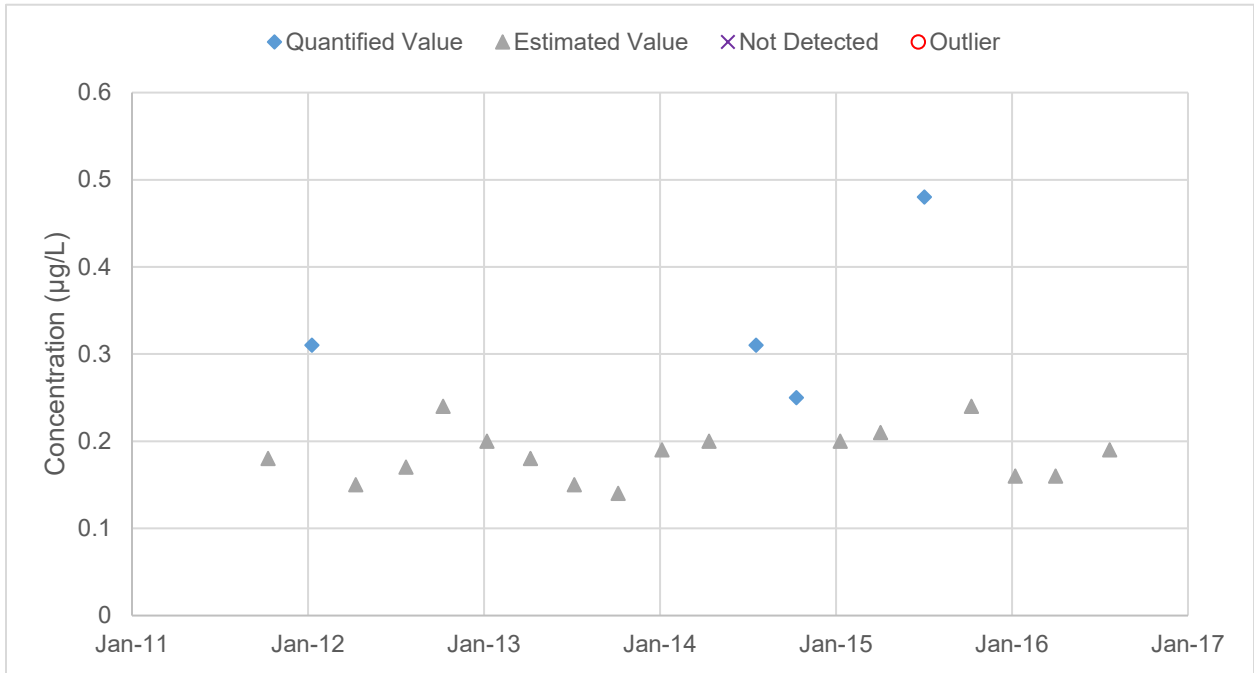

Figure B-8: Cadmium Concentration in Facility Effluent

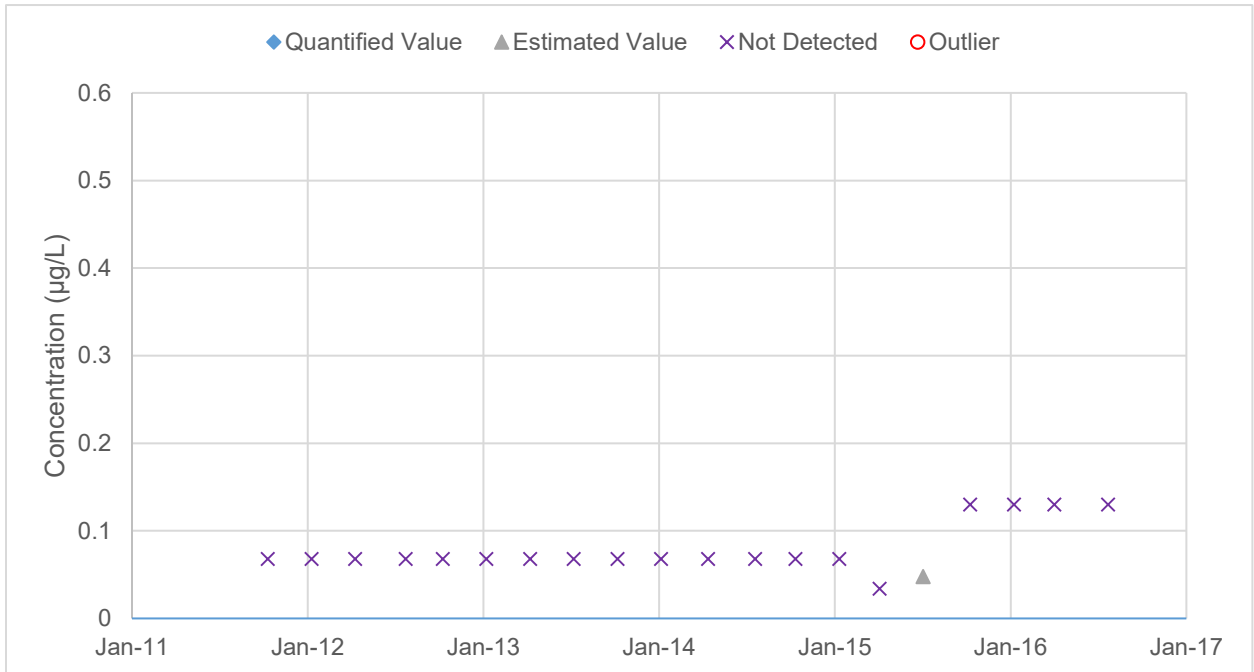

Figure B-9: Chromium Concentration in Facility Influent

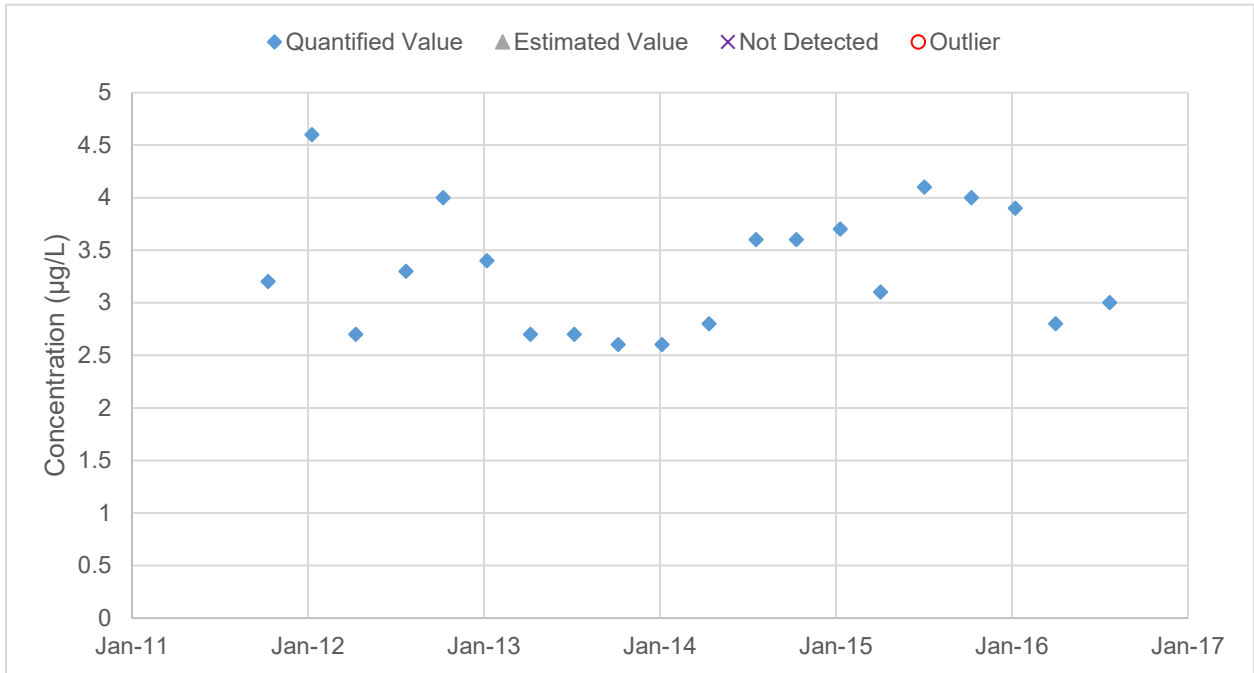

Figure B-10: Chromium Concentration in Facility Effluent

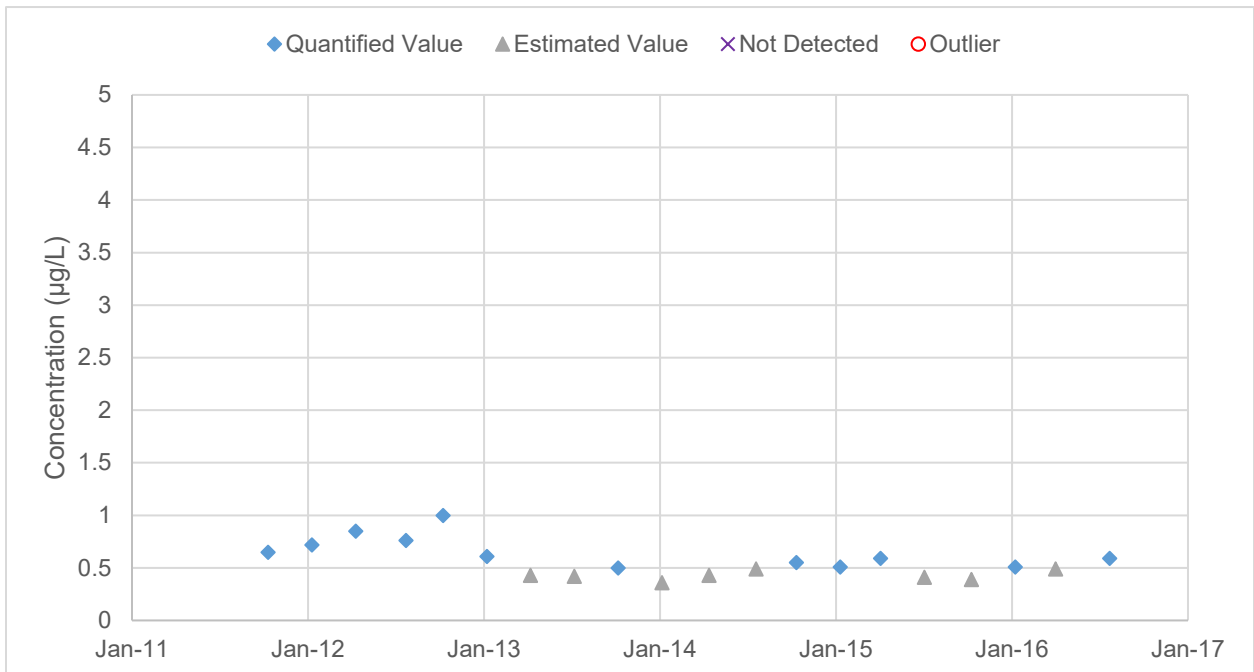

Figure B-11: Copper Concentration in Facility Influent

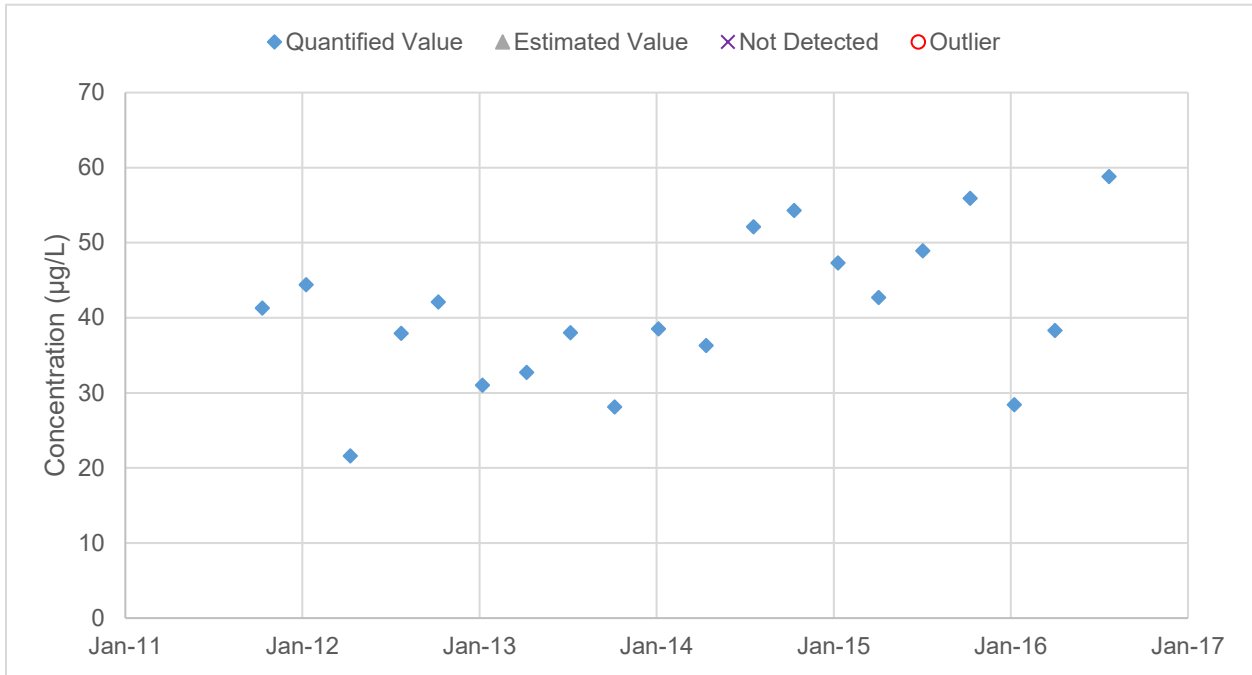

Figure B-12: Copper Concentration in Facility Effluent

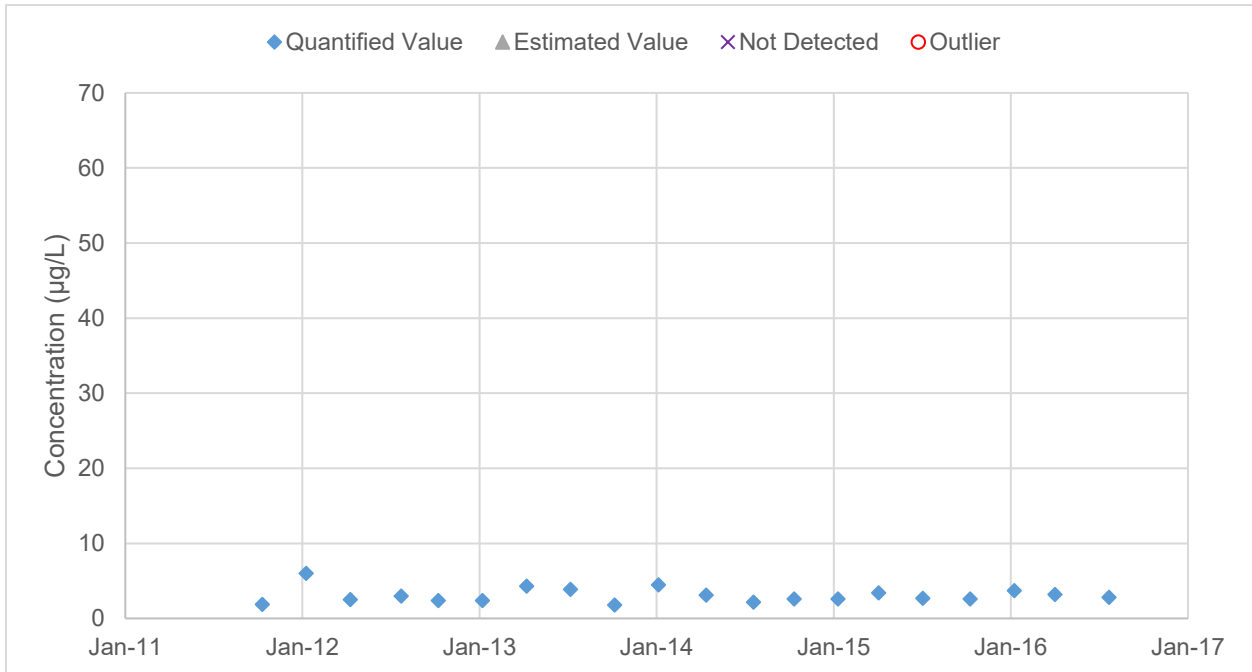

Figure B-13: Cyanide Concentration in Facility Influent

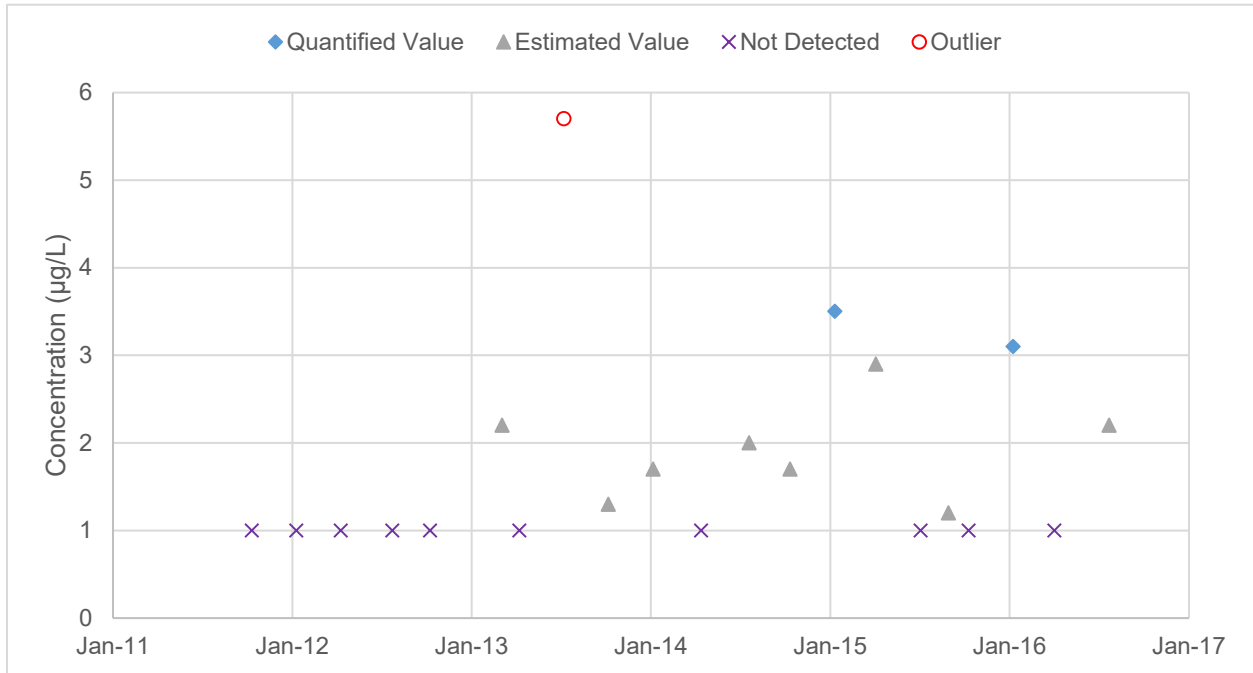

Figure B-14: Cyanide Concentration in Facility Effluent

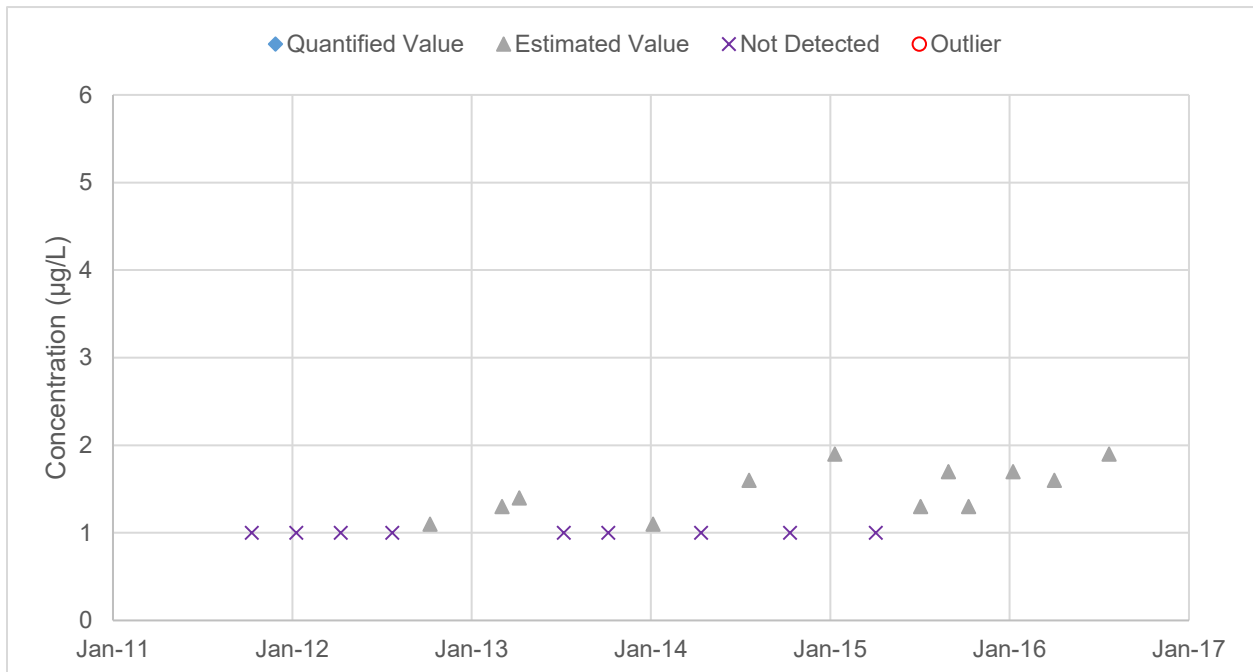

Figure B-15: Lead Concentration in Facility Influent

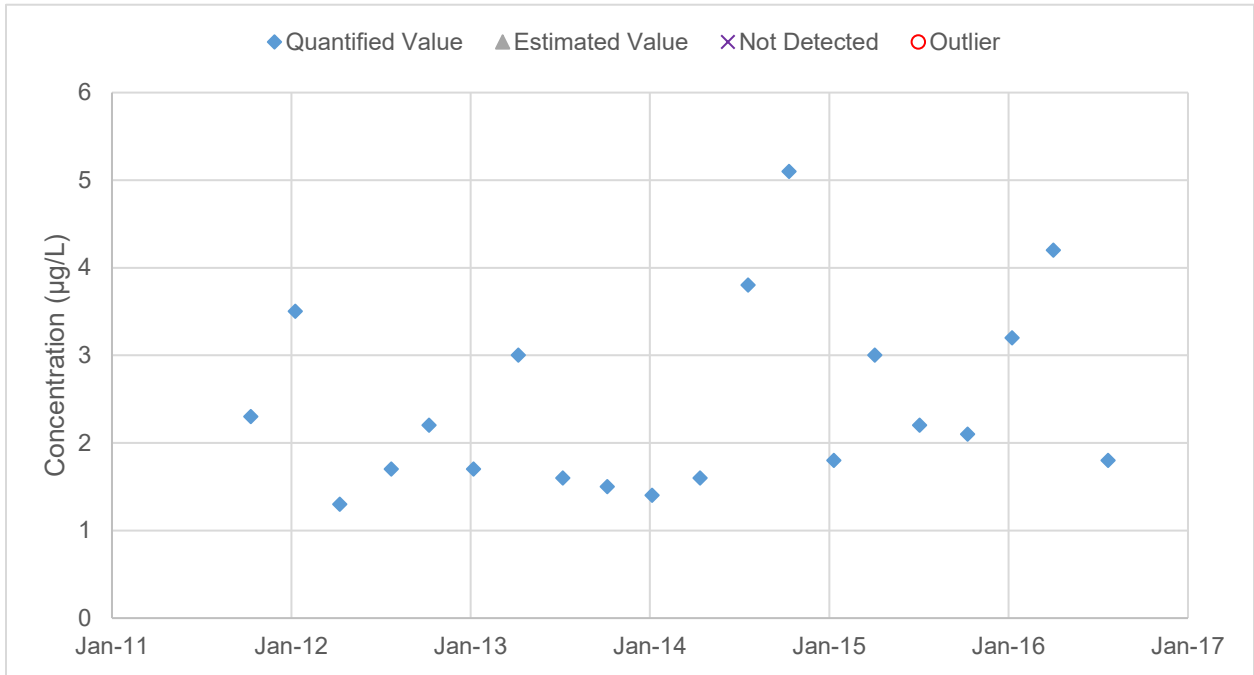

Figure B-16: Lead Concentration in Facility Effluent

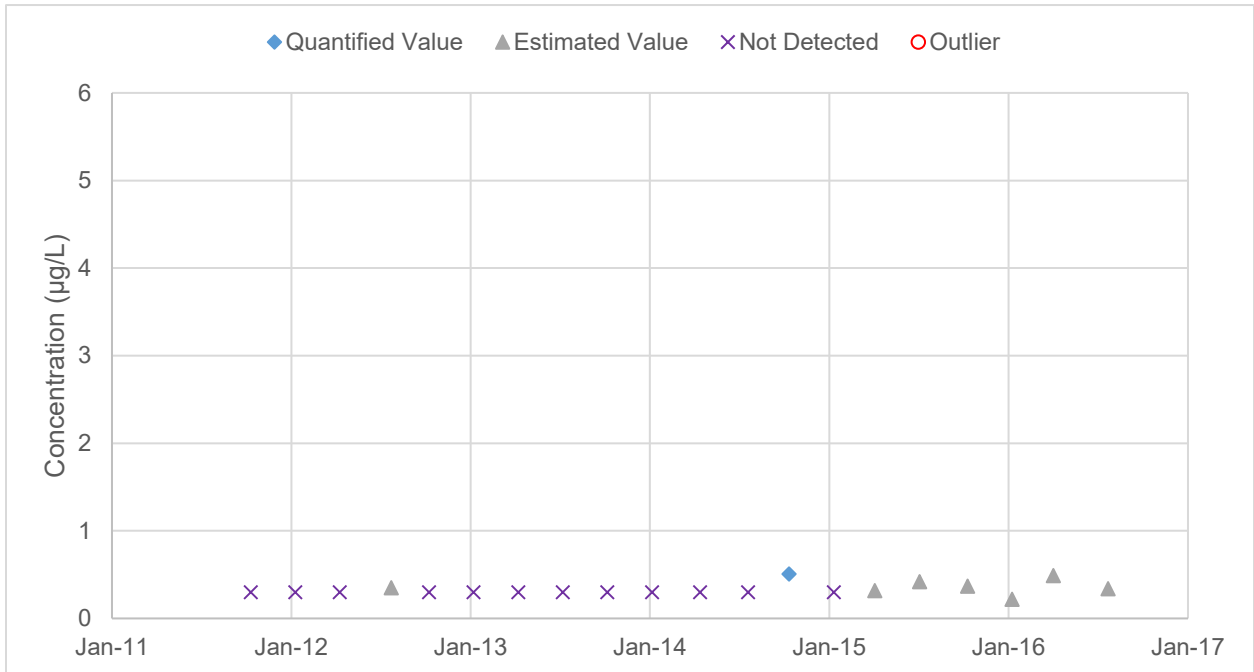

Figure B-17: Mercury Concentration in Facility Influent

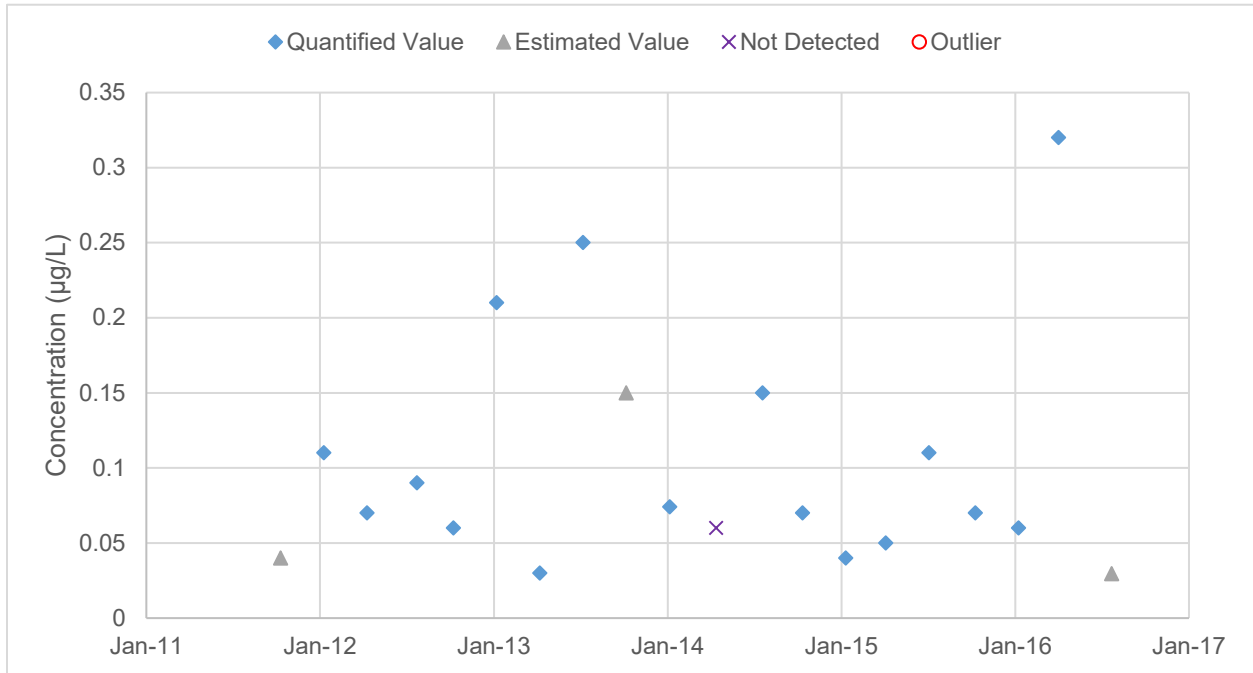

Figure B-18: Mercury Concentration in Facility Effluent

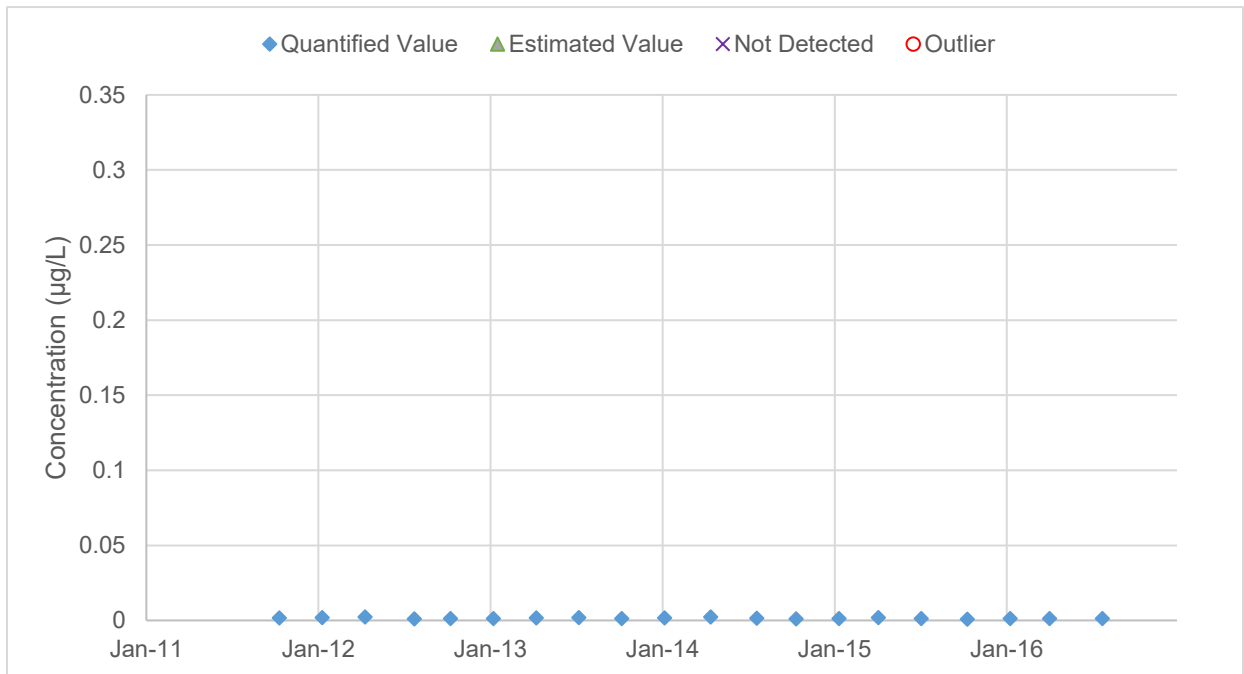

Figure B-19: Nickel Concentration in Facility Influent

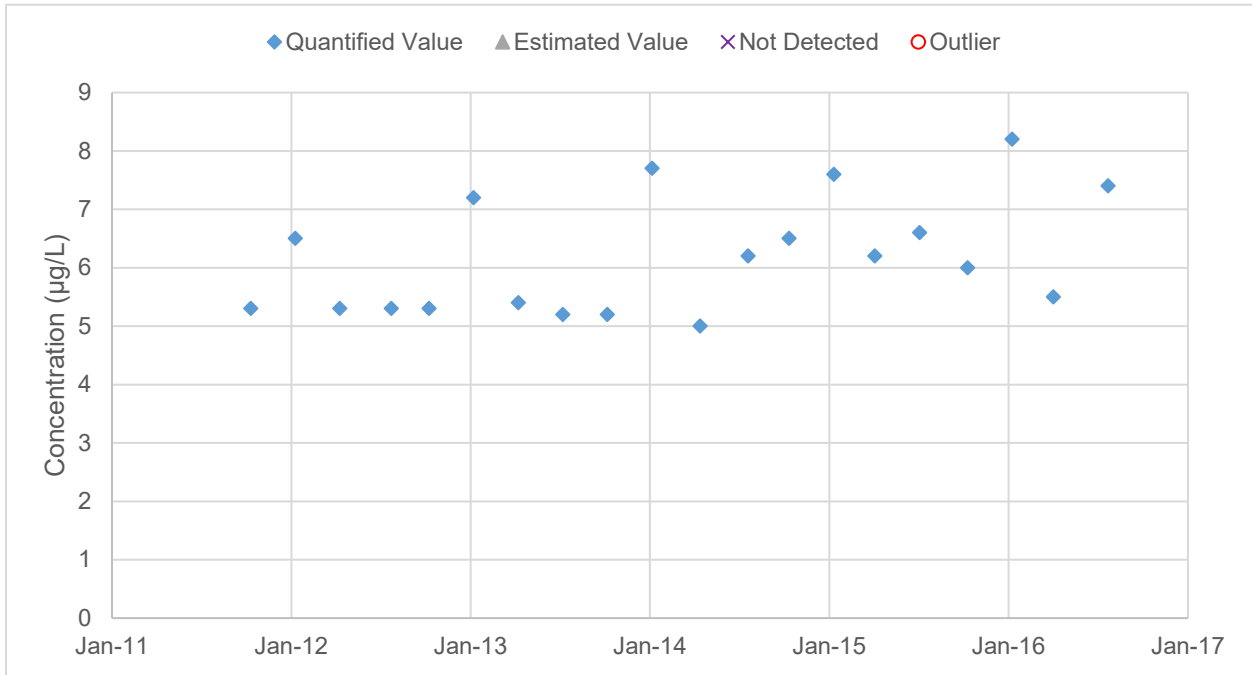

Figure B-20: Nickel Concentration in Facility Effluent

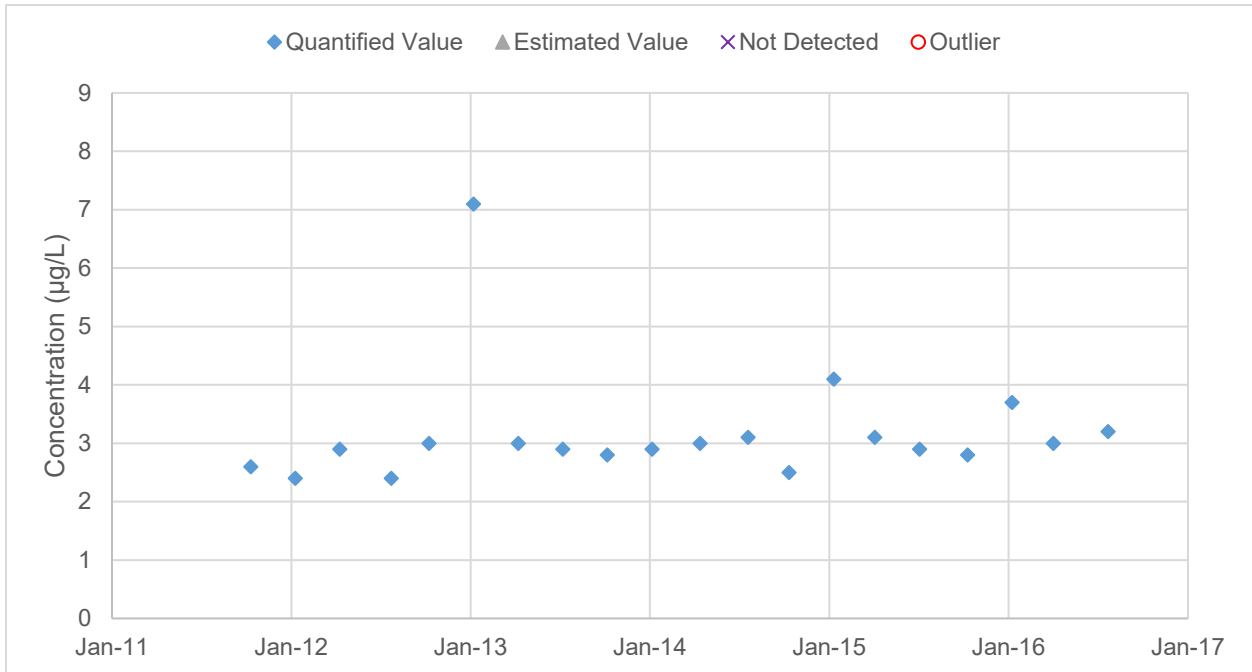

Figure B-21: Selenium Concentration in Facility Influent

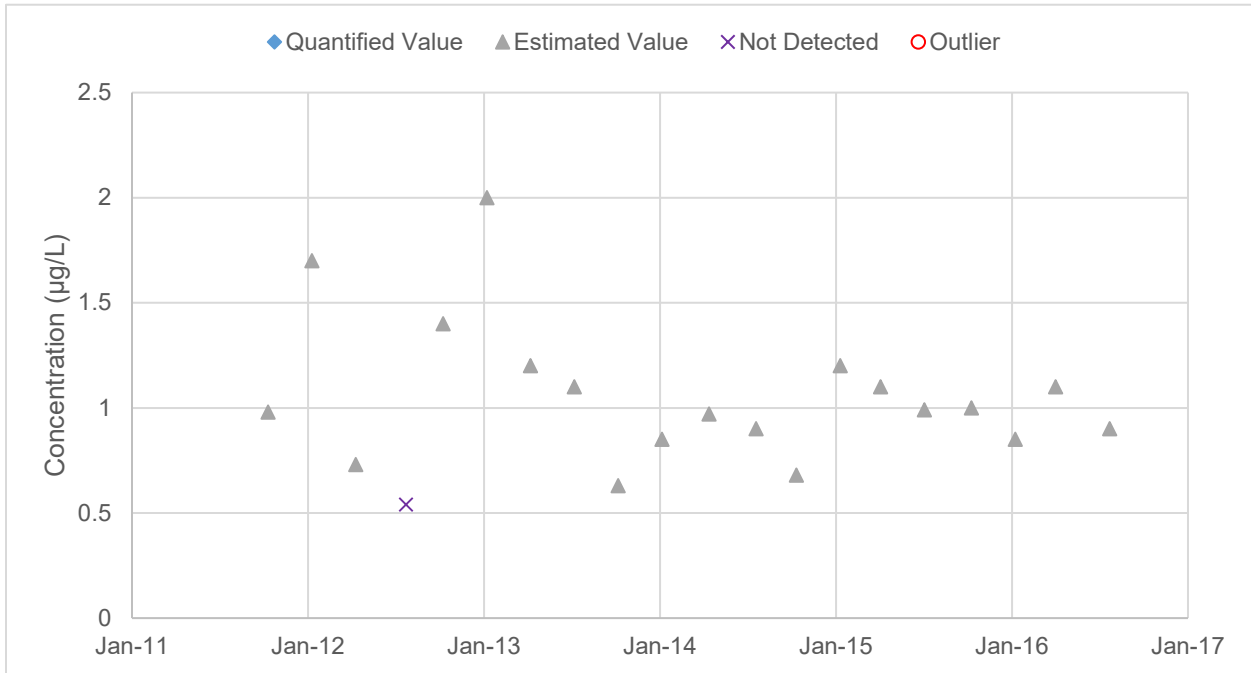

Figure B-22: Selenium Concentration in Facility Effluent

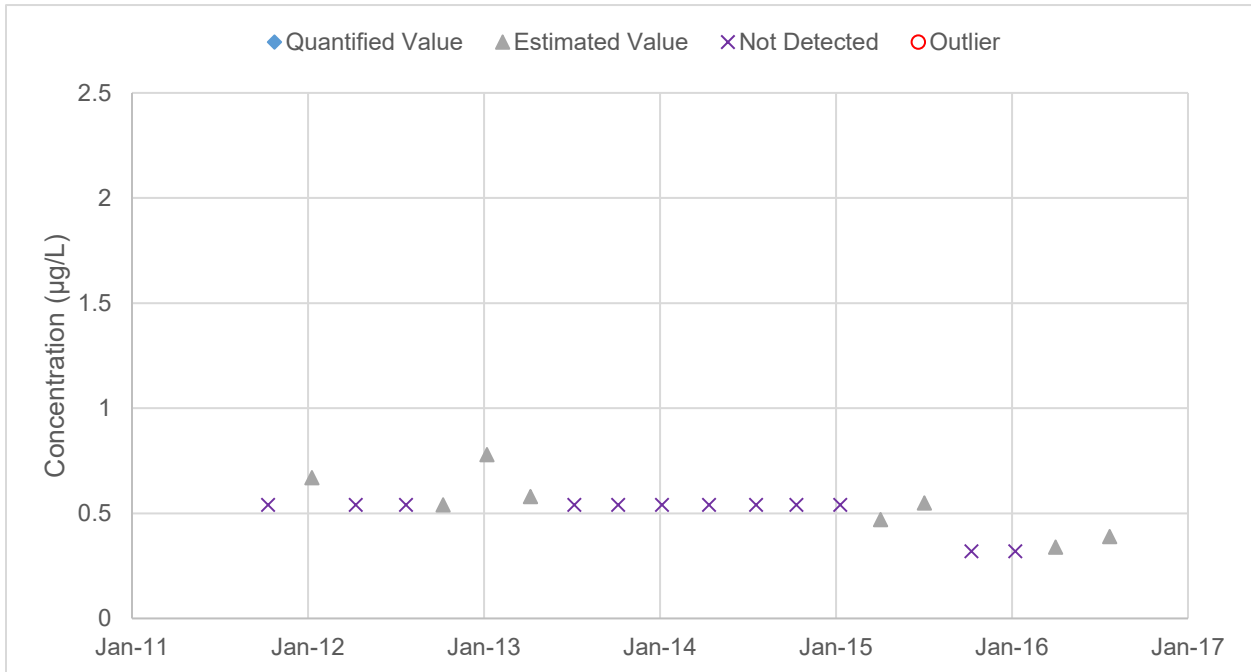

Figure B-23: Silver Concentration in Facility Influent

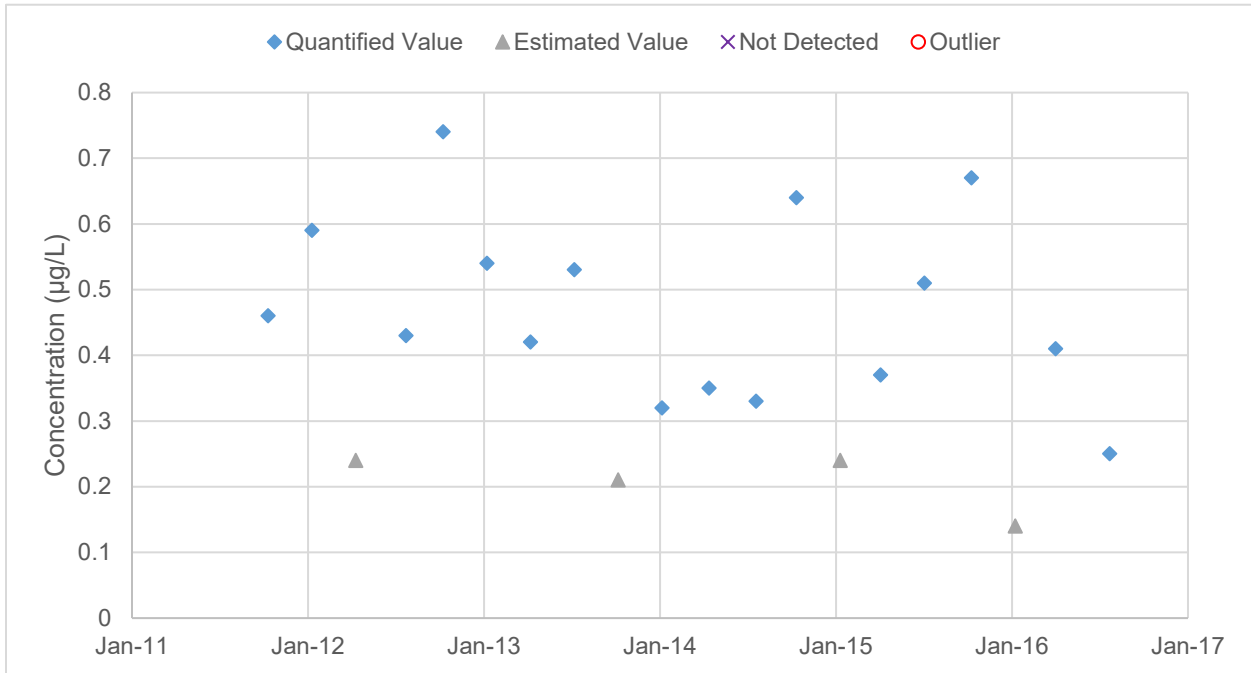

Figure B-24: Silver Concentration in Facility Effluent

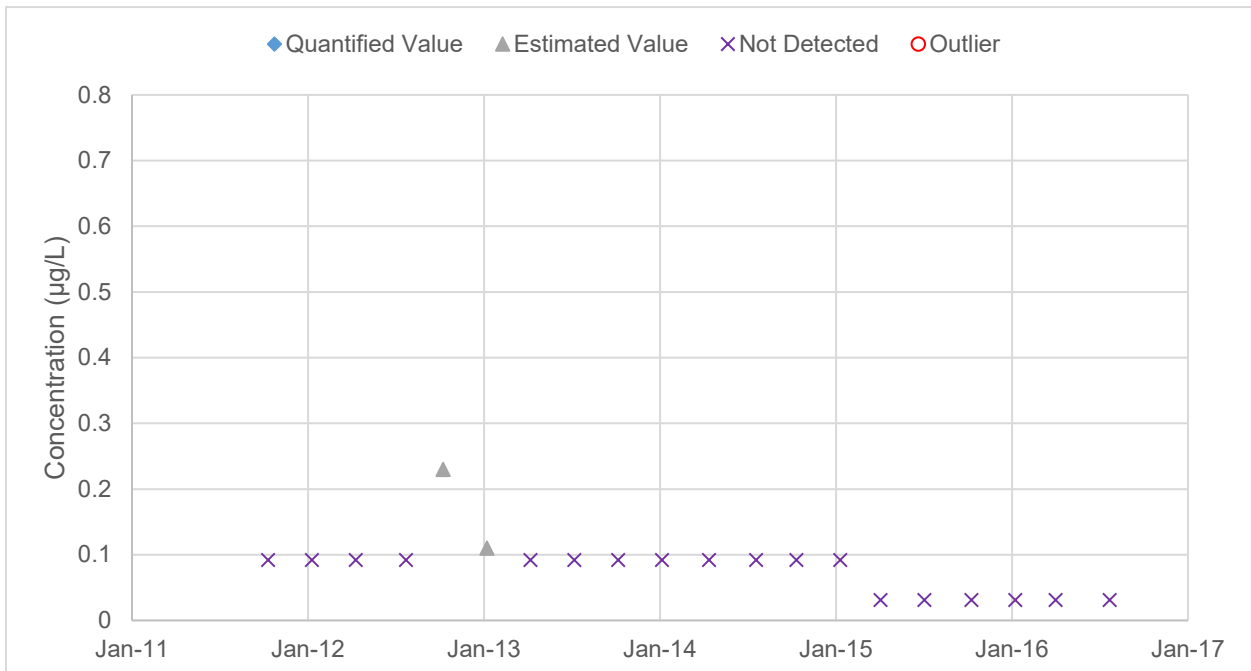

Figure B-25: Thallium Concentration in Facility Influent

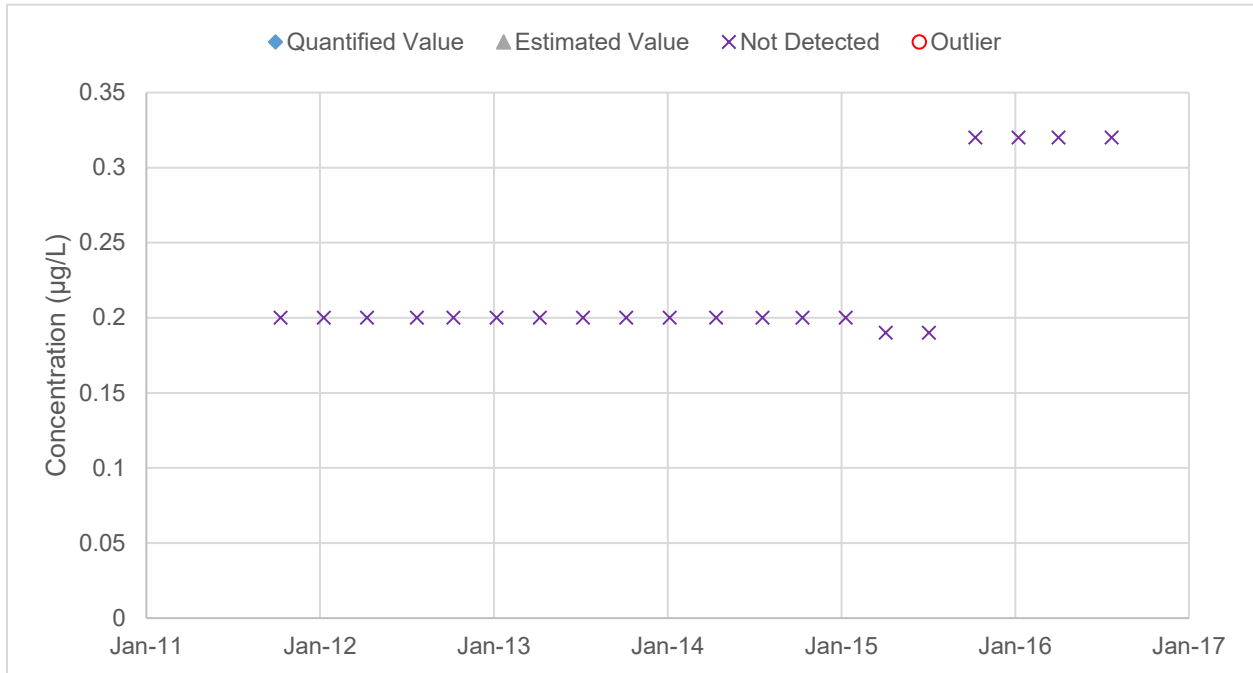

Figure B-26: Thallium Concentration in Facility Effluent

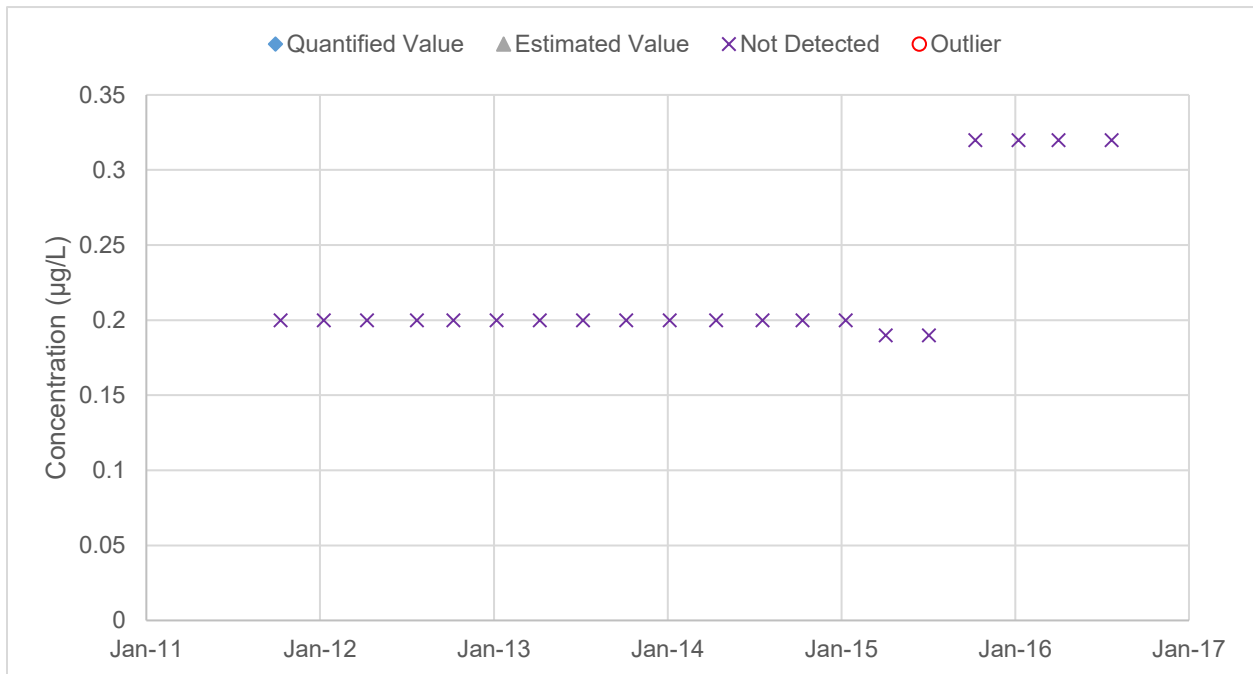

Figure B-27: Zinc Concentration in Facility Influent

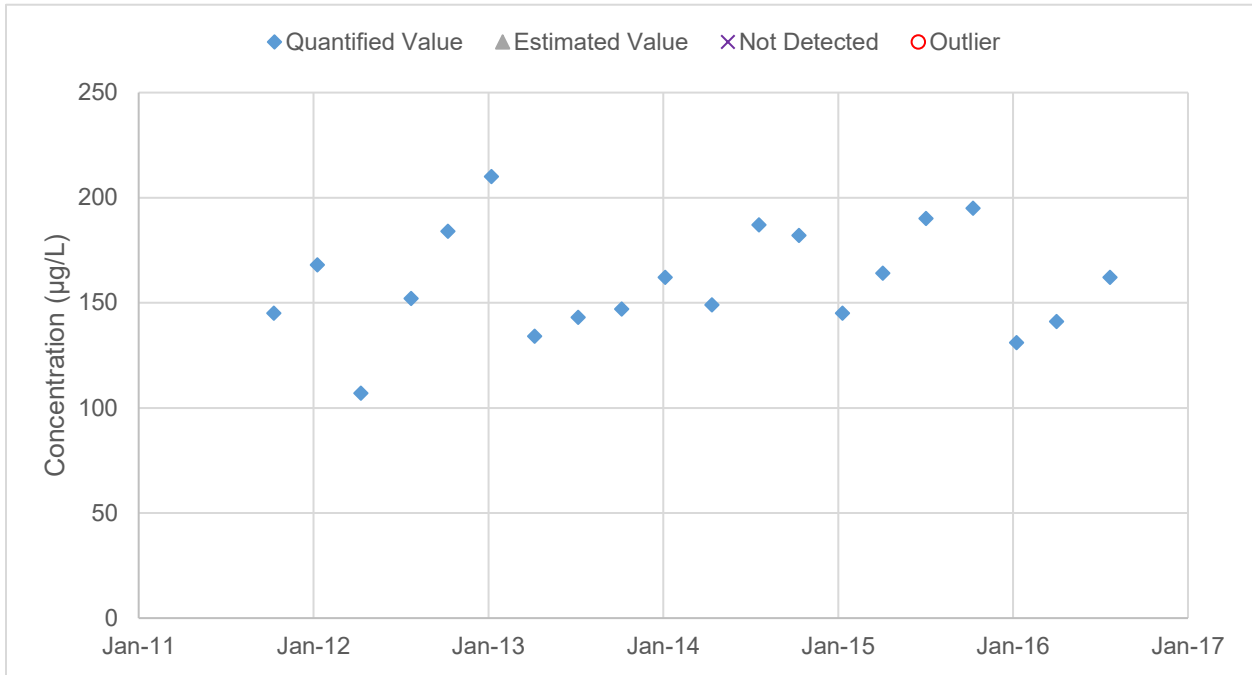

Figure B-28: Zinc Concentration in Facility Effluent

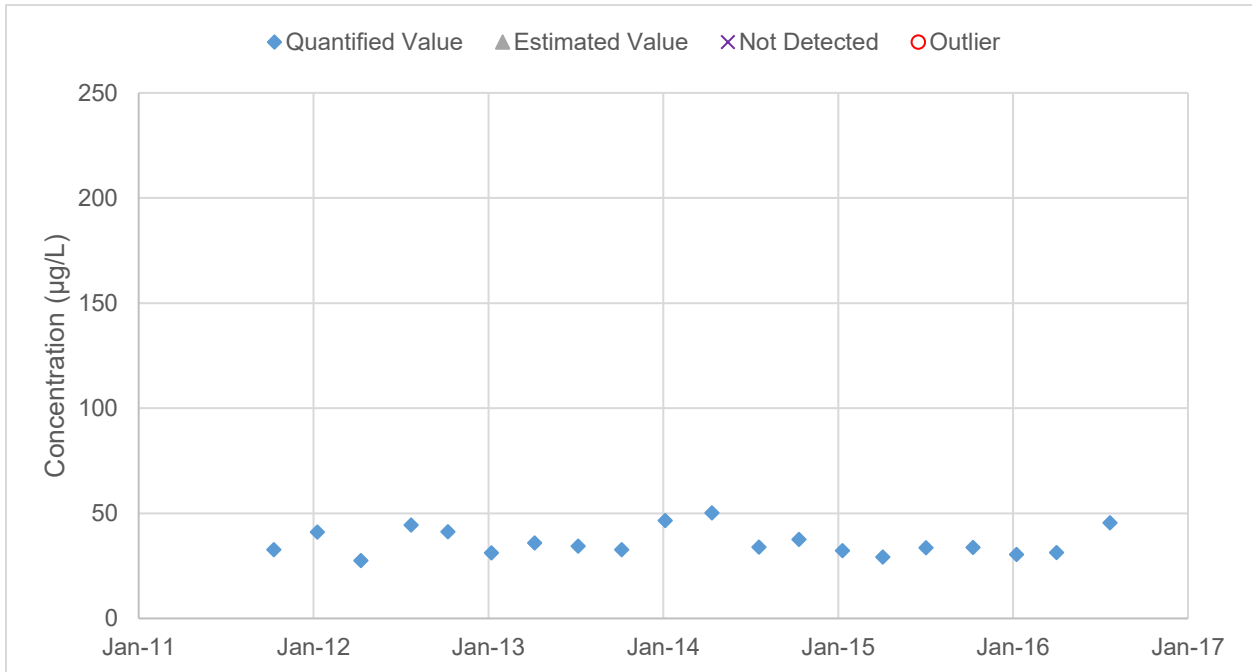

Figure B-29: Benzidine Concentration in Facility Influent

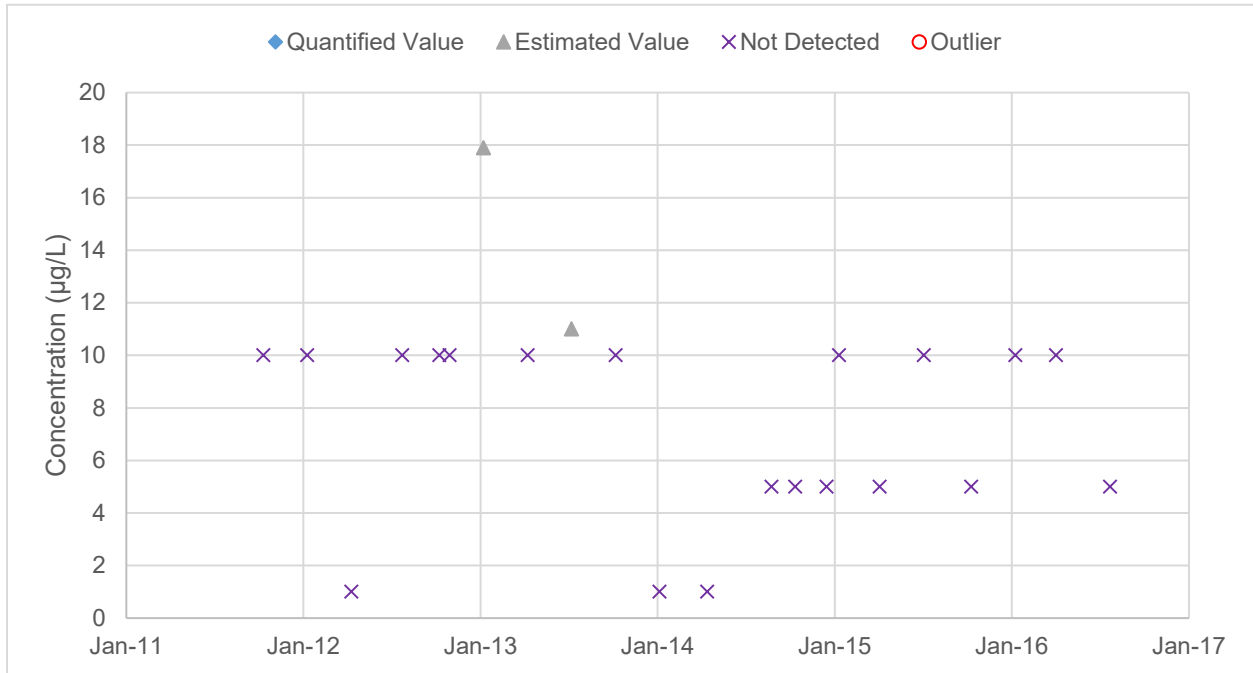

Figure B-30: Benzidine Concentration in Facility Effluent

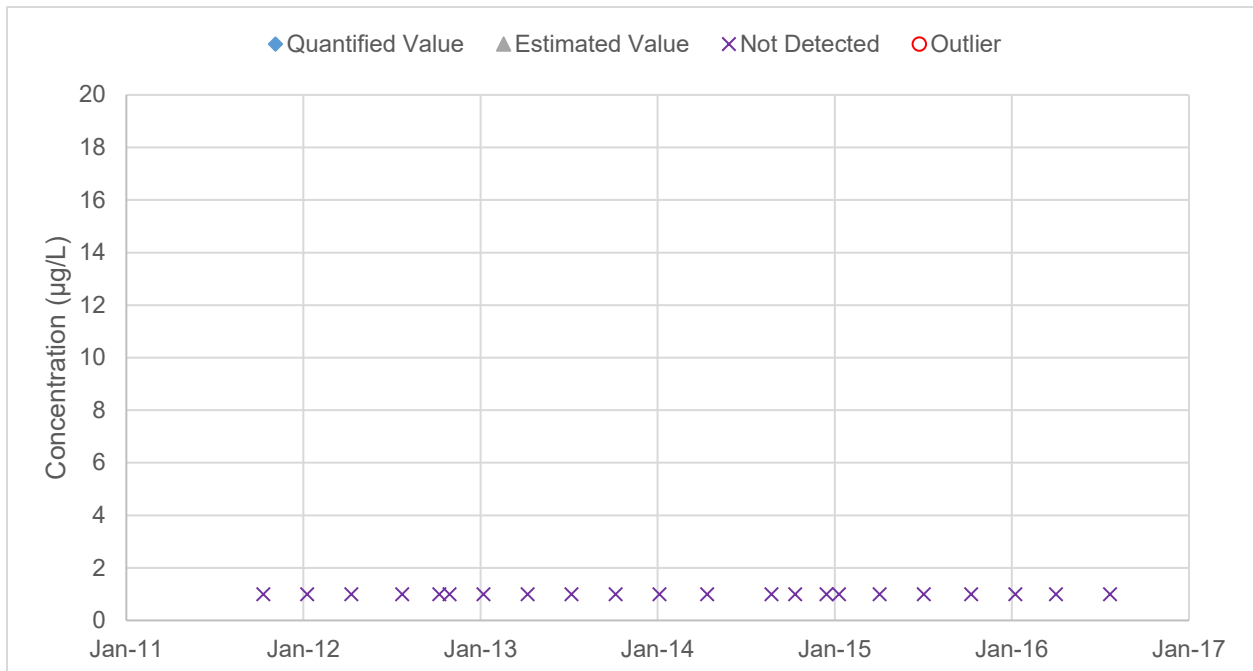

Figure B-31: Bis (2-Ethylhexyl) Phthalate Concentration in Facility Influent

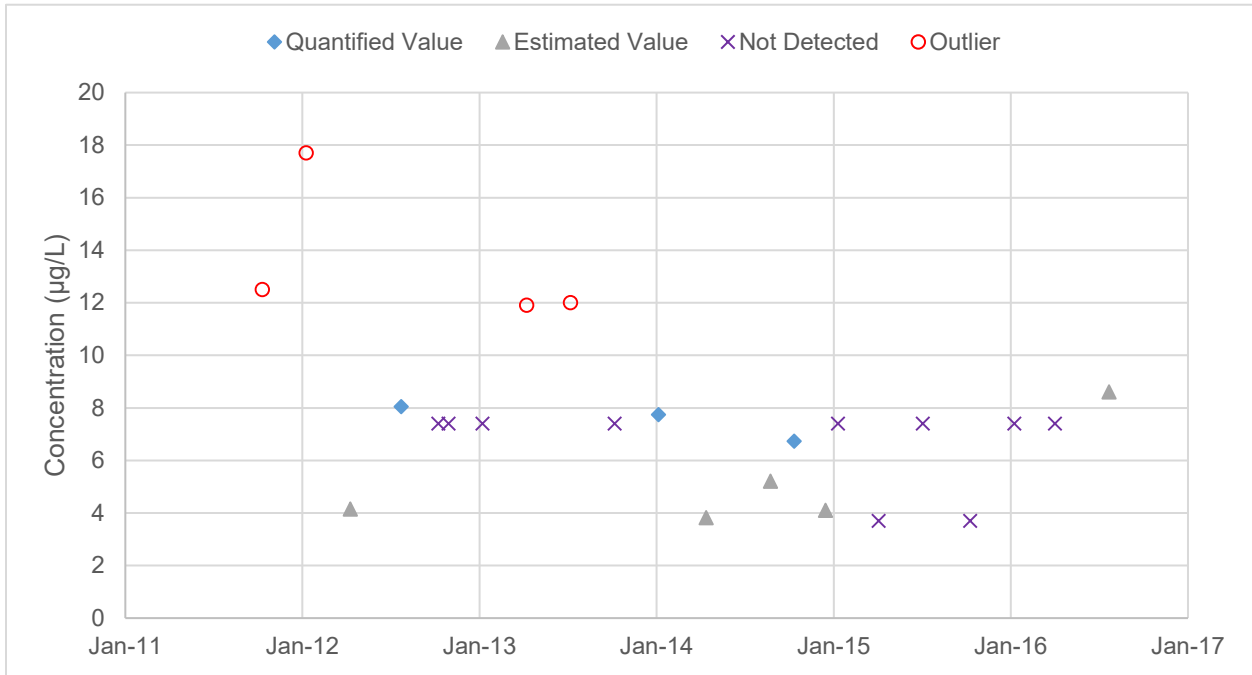

Figure B-32: Bis (2-Ethylhexyl) Phthalate Concentration in Facility Effluent

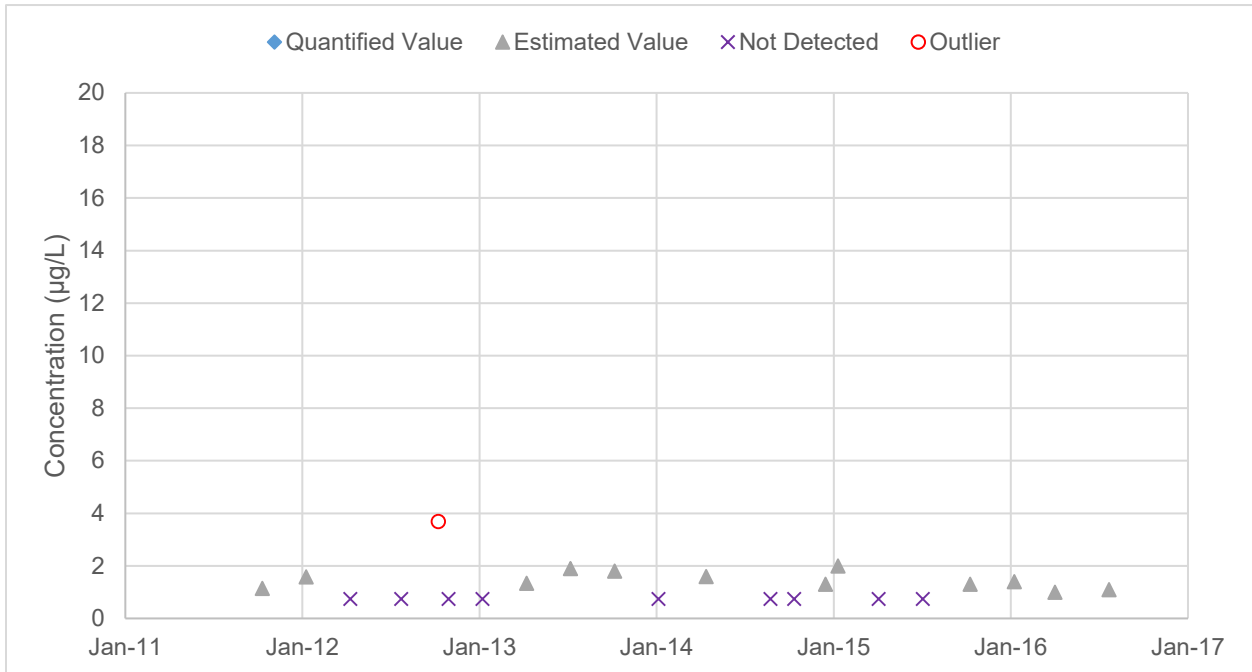

Figure B-33: Dibromochloromethane Concentration in Facility Influent

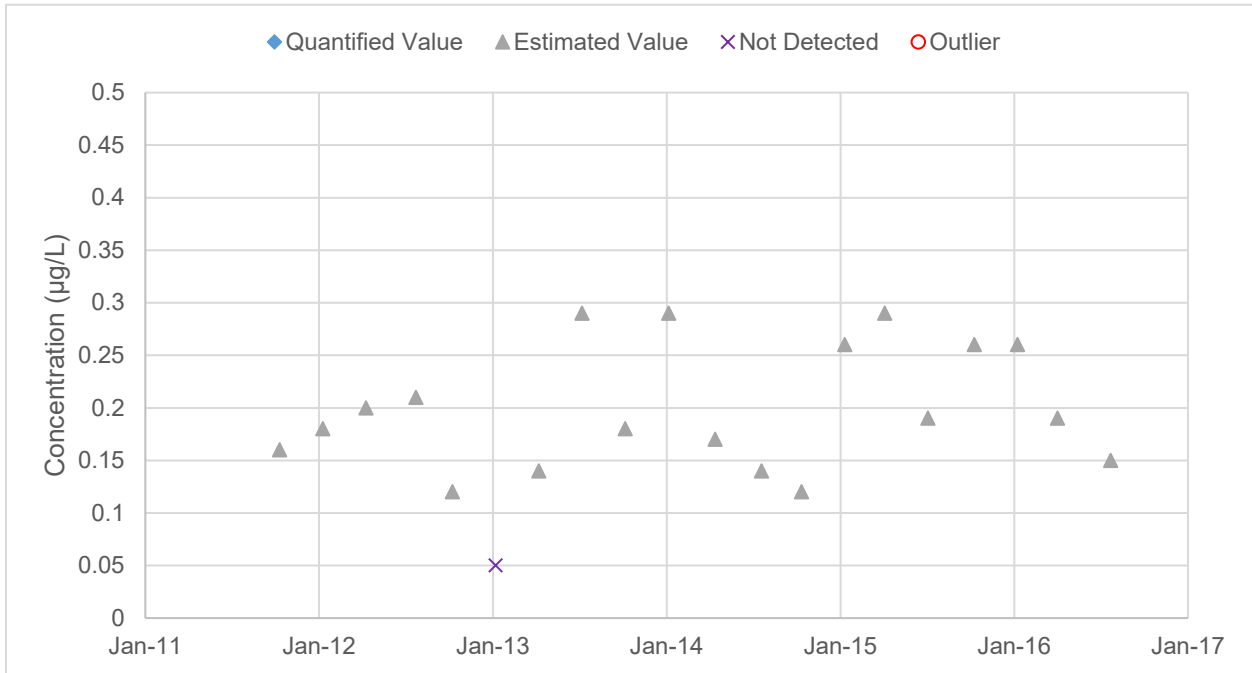

Figure B-34: Dibromochloromethane Concentration in Facility Effluent

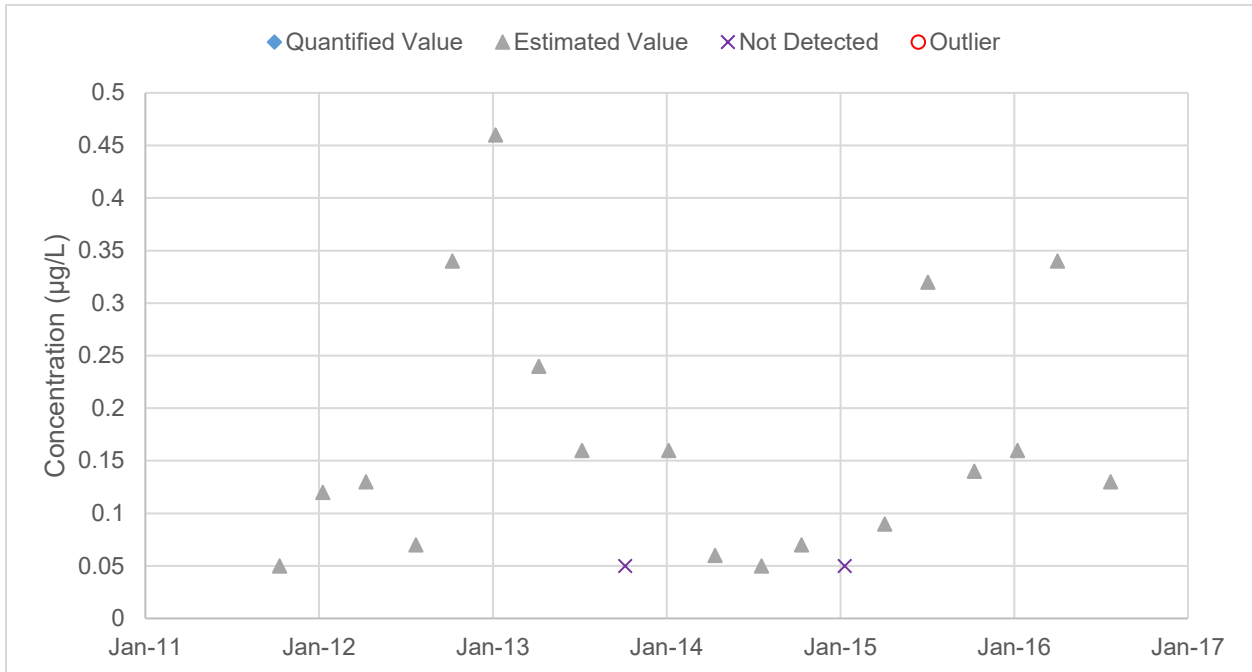

Figure B-35: Dichlorobromomethane Concentration in Facility Influent

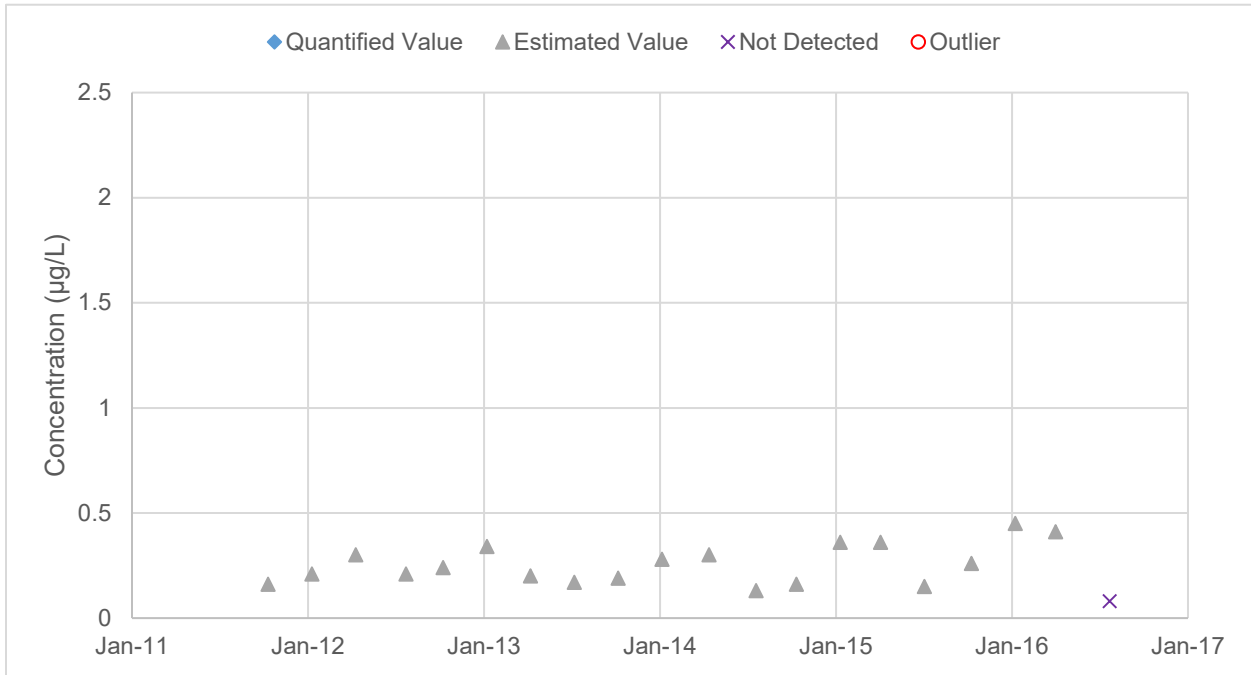

Figure B-36: Dichlorobromomethane Concentration in Facility Effluent

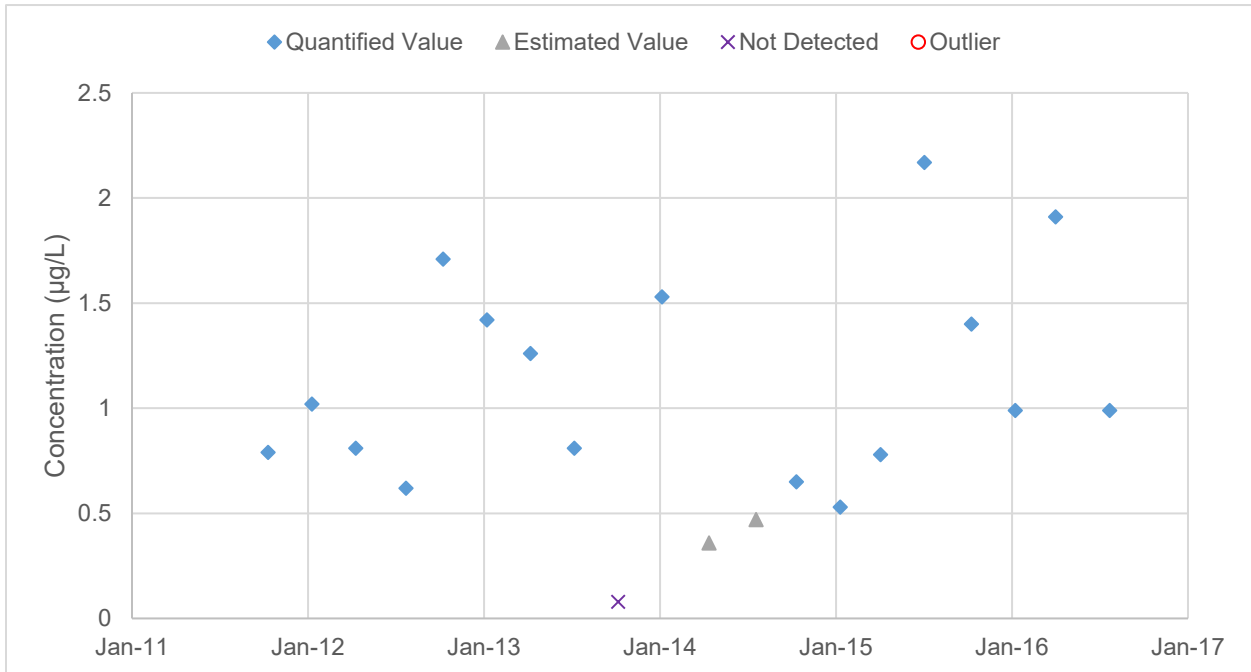

Figure B-37: Total Dissolved Solids (TDS) Concentration in Facility Effluent

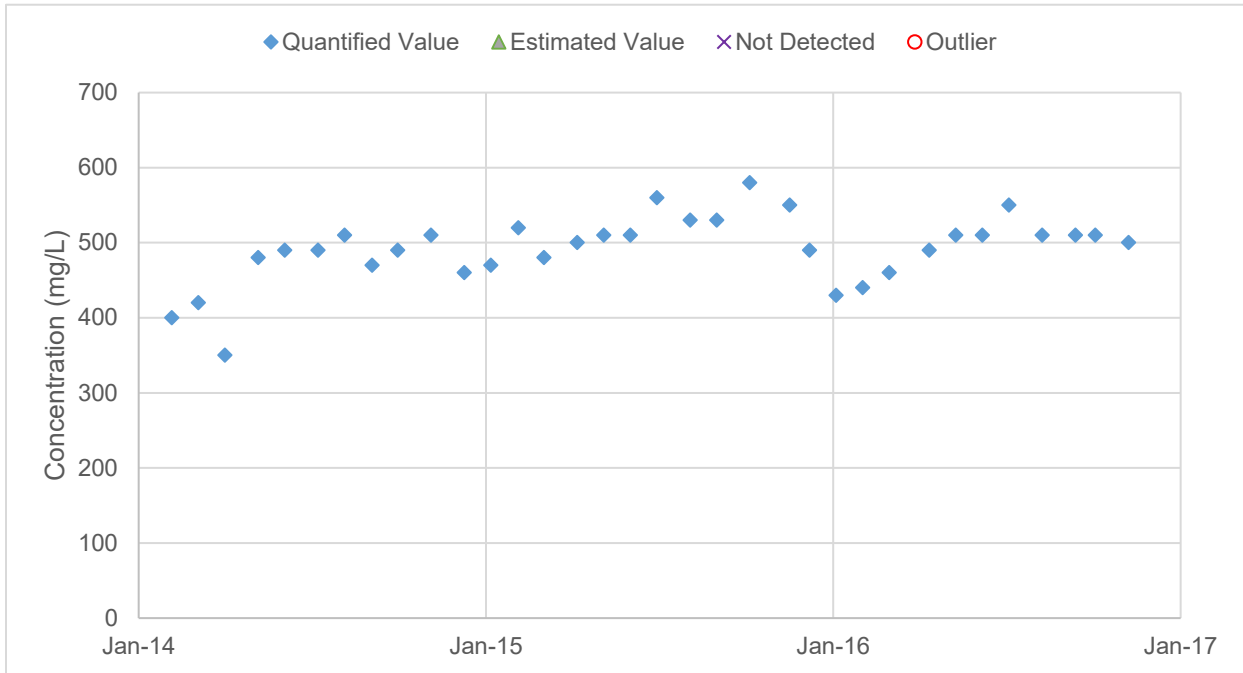

Figure B-38: Chloride Concentration in Facility Effluent

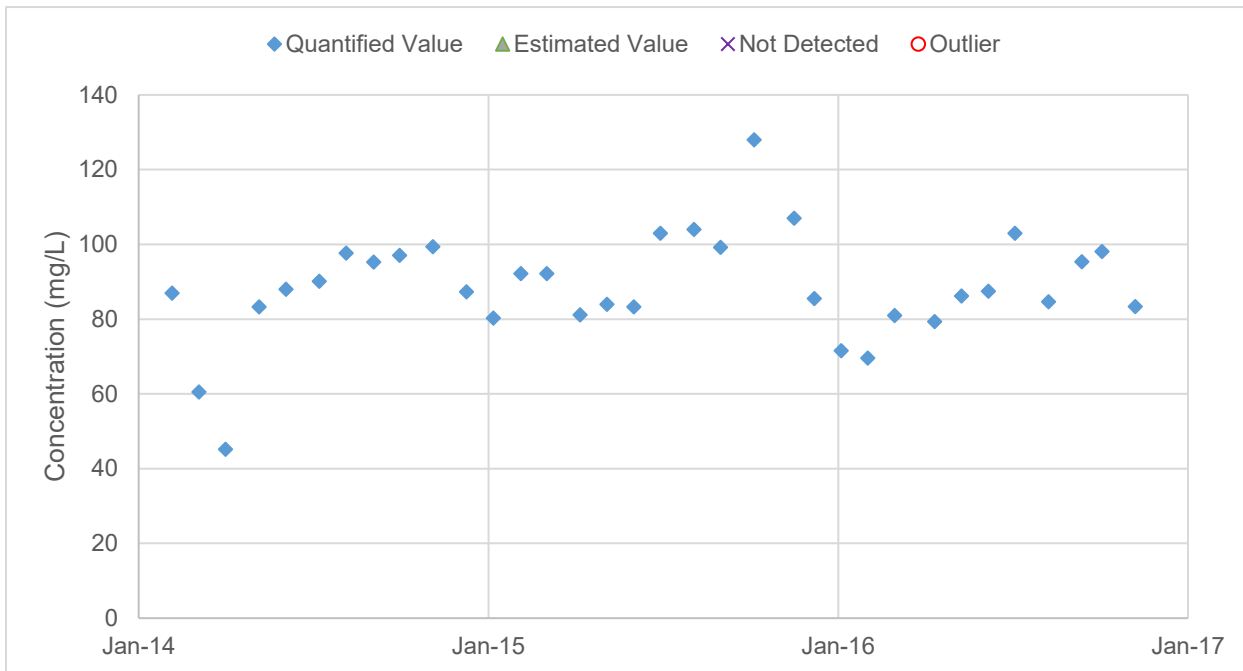

Figure B-39: Sodium Concentration in Facility Effluent

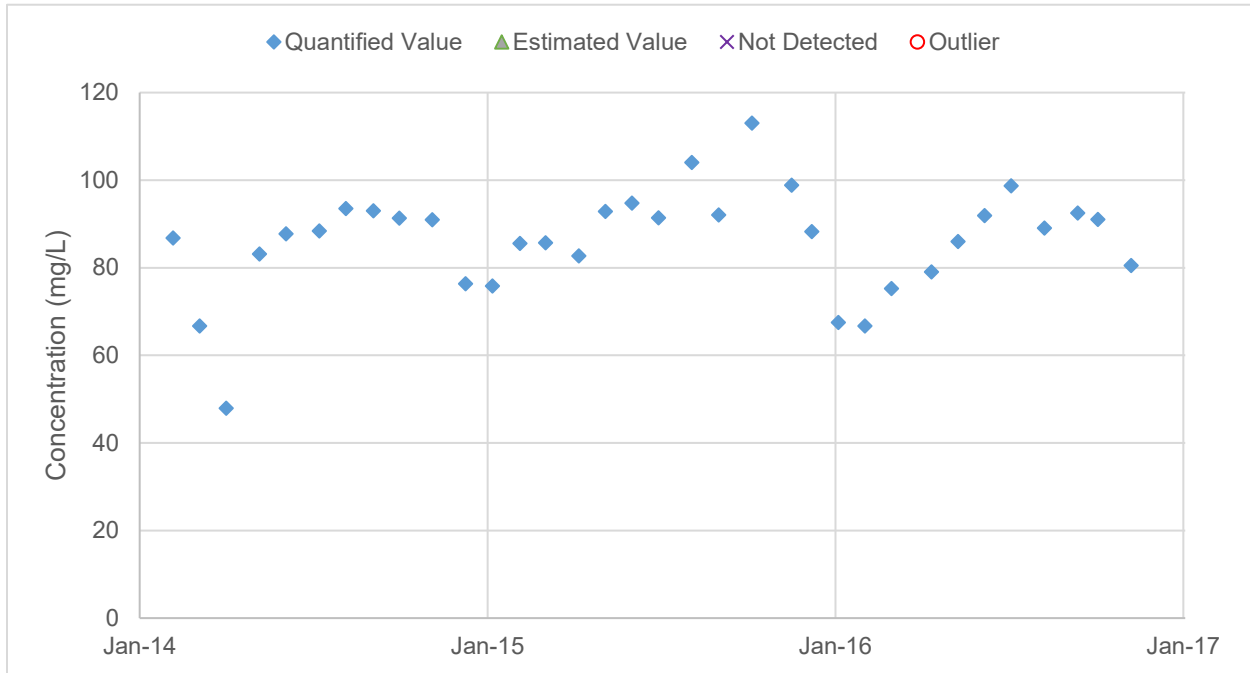

Figure B-40: Biochemical Oxygen Demand (BOD) Concentration in Facility Influent

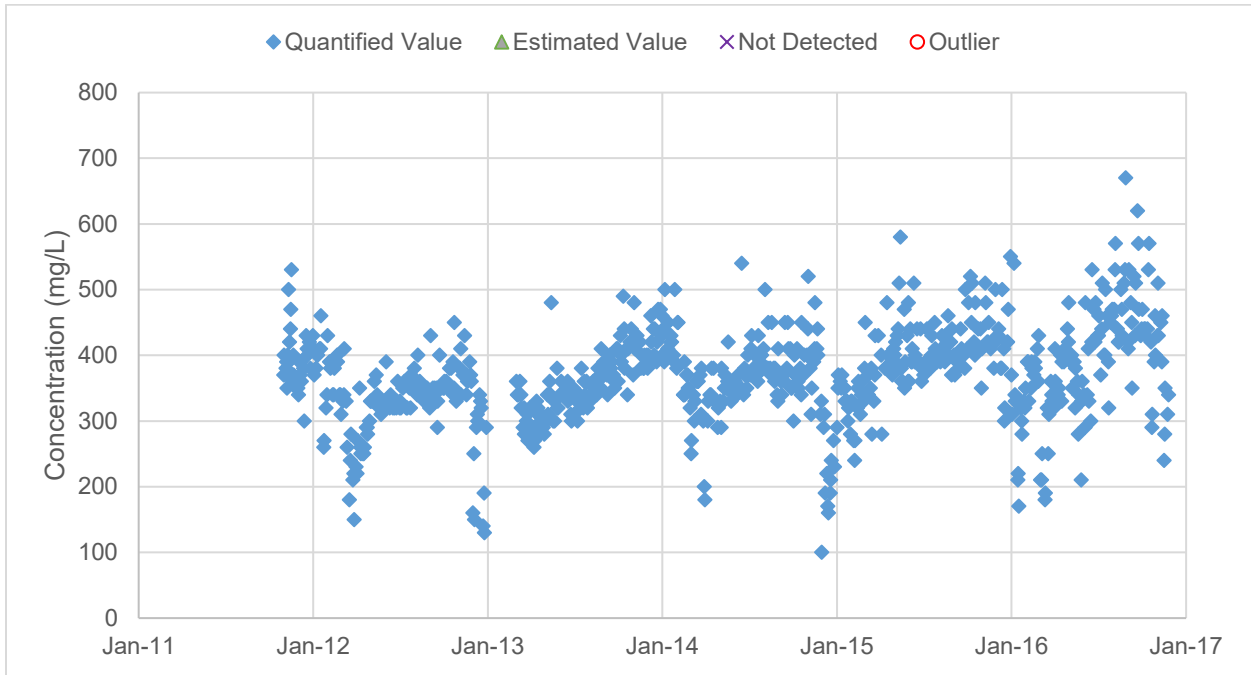

Figure B-41: Biochemical Oxygen Demand (BOD) Concentration in Facility Effluent

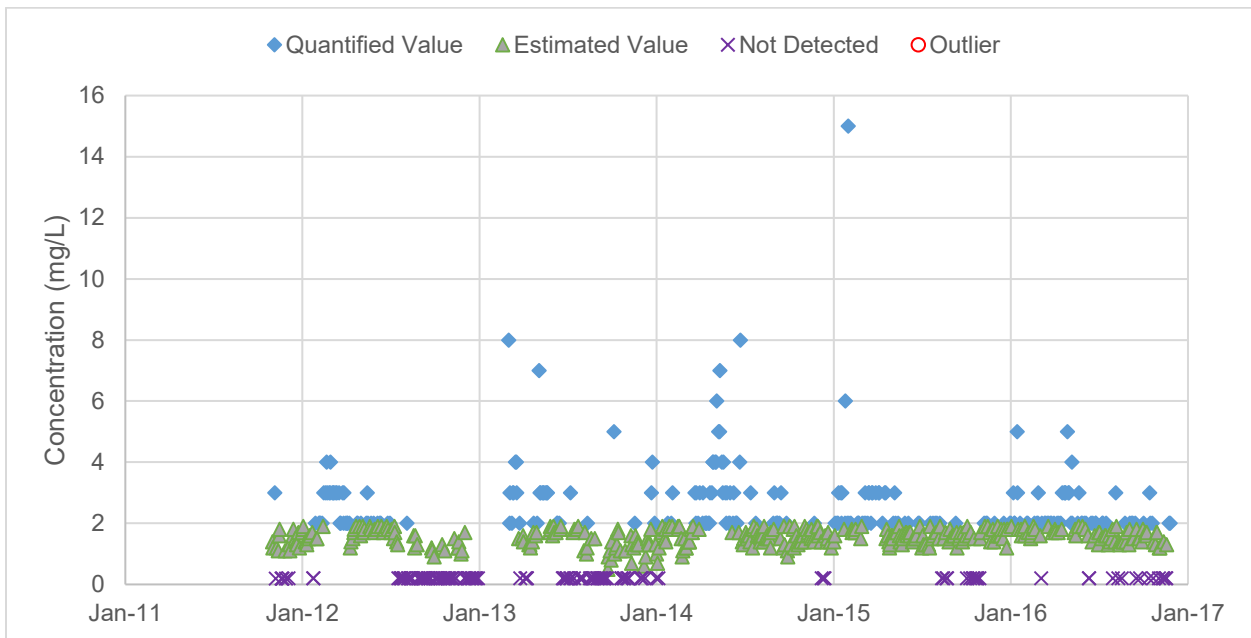

Figure B-42: Total Suspended Solids (TSS) Concentration in Facility Influent

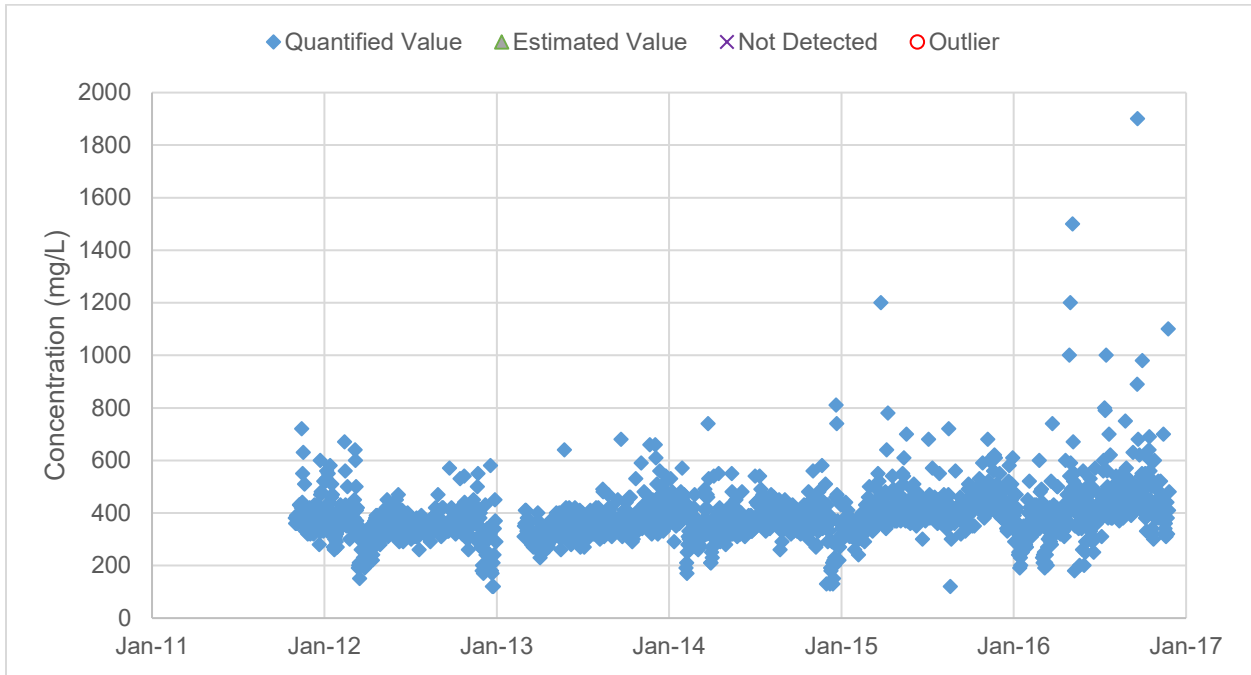
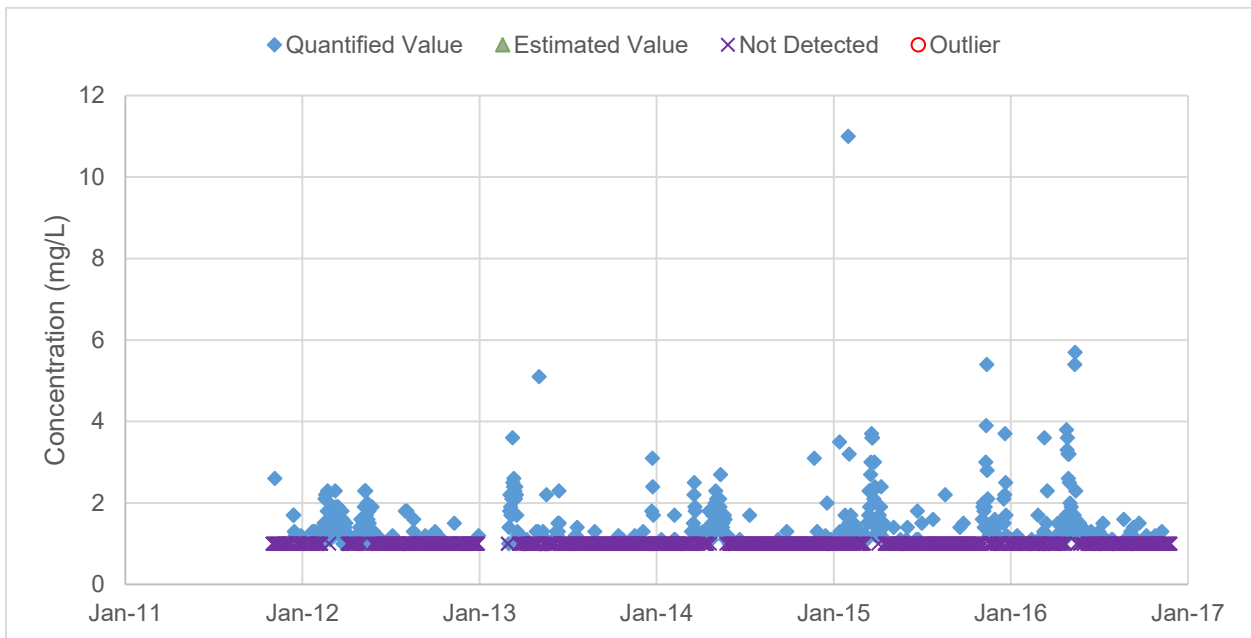

Figure B-43: Total Suspended Solids (TSS) Concentration in Facility Effluent



Not Shown: Quantified Value of 52 mg/L from 4/10/2015

Figure B-44: Total Kjeldahl Nitrogen (TKN) Concentration in Facility Influent

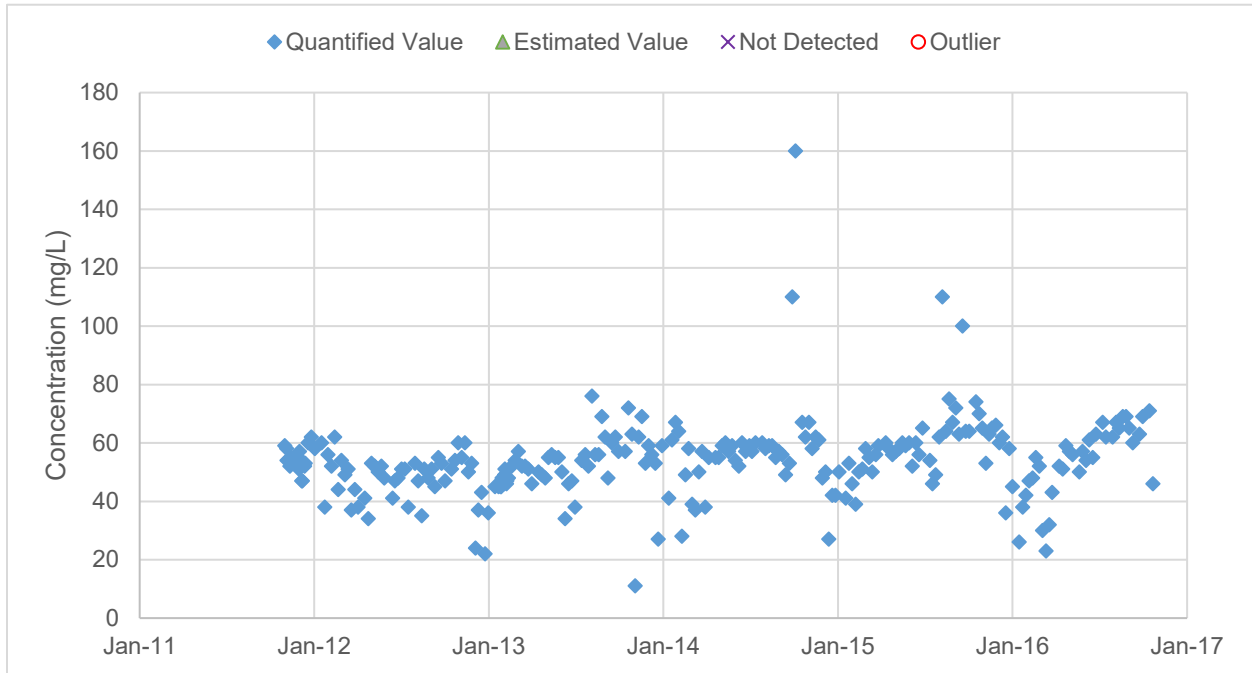

Figure B-45: Total Nitrogen Concentration in Facility Effluent (Calculated)

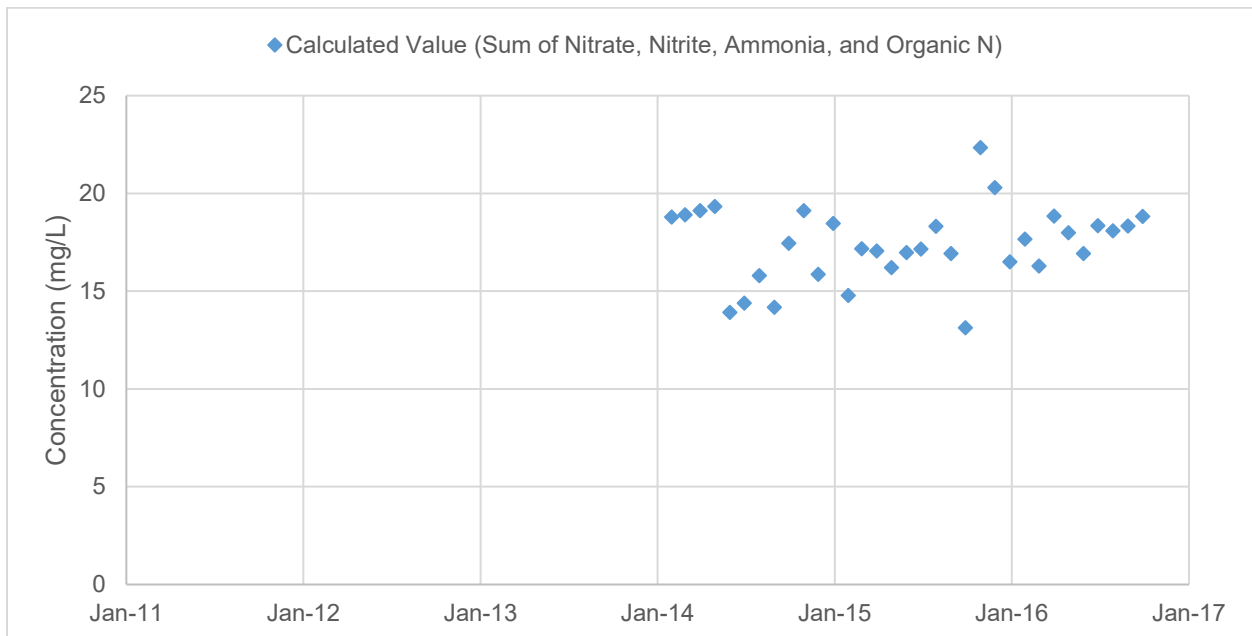

Figure B-48: Selenium Concentration in Industrial Wastewater

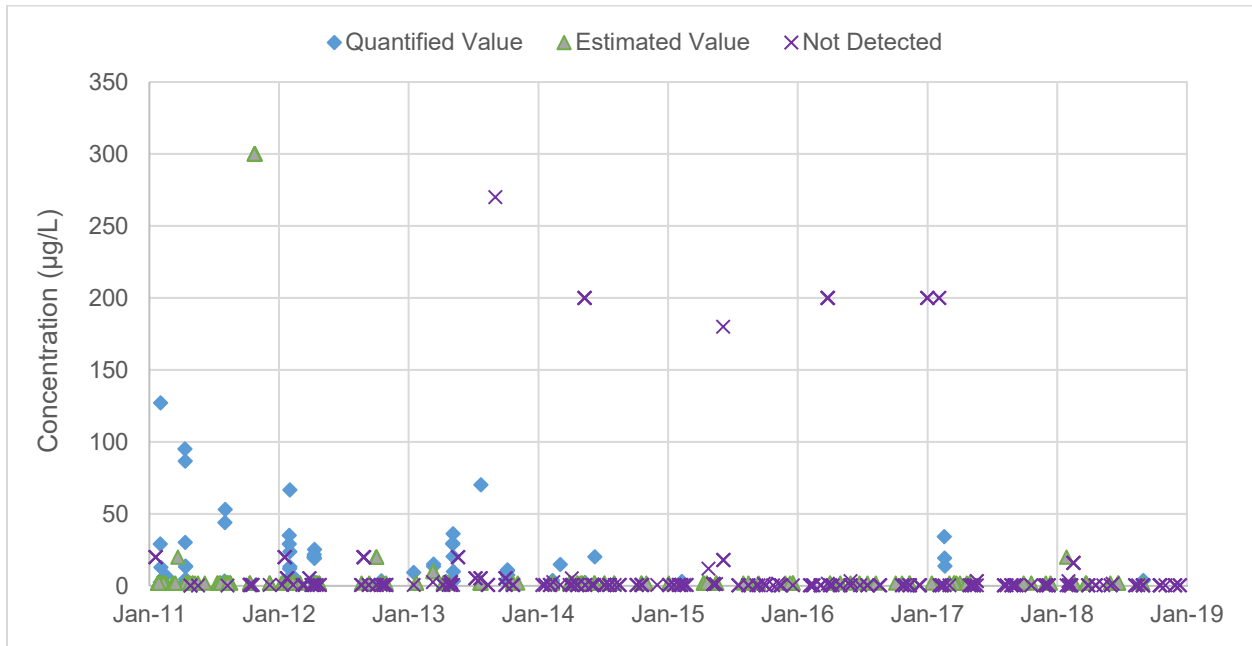
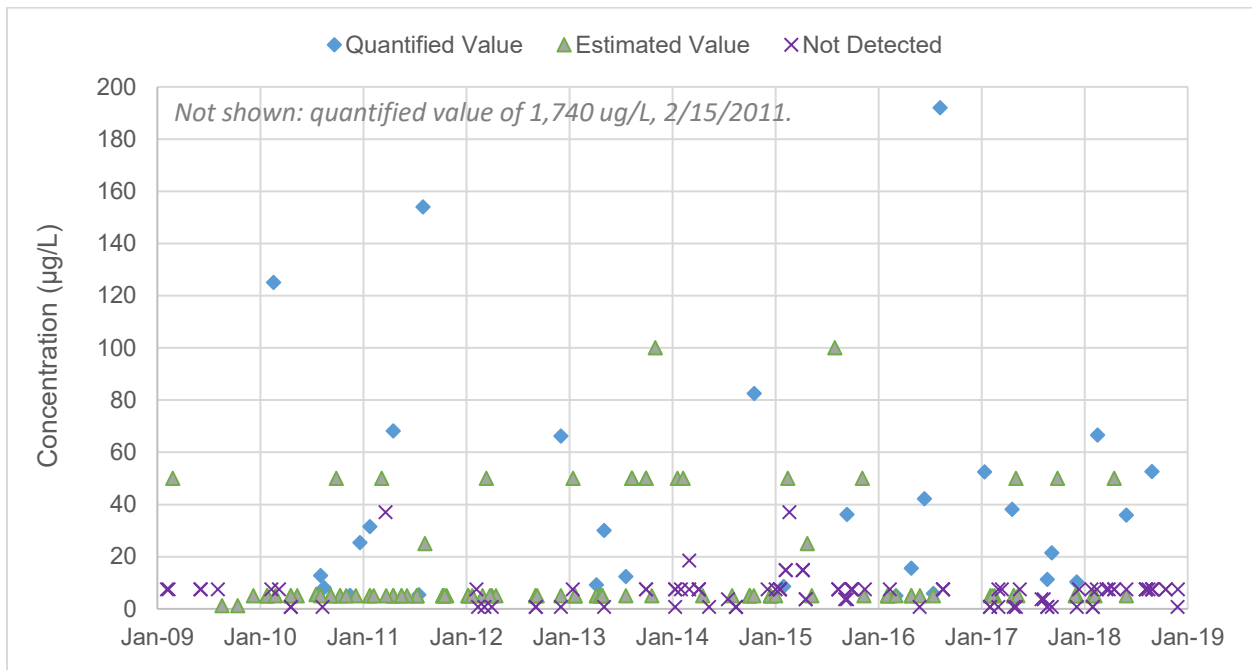

Figure B-49: Bis (2-ethylhexyl) phthalate Concentration in Industrial Wastewater



Appendix C - Halogenated TTO Local Limit

The term “Halogenated TTO” shall mean halogenated total toxic organics, which is the summation of all quantifiable values greater than 5 micrograms per liter ($\mu\text{g/L}$) for the following constituents:

- Carbon tetrachloride (tetrachloromethane)
- Chlorobenzene
- 1,2,4- Trichlorobenzene
- 1,2-Dichloroethane
- 1,1,1-Trichloroethane
- 1,1-Dichloroethane
- 1,1,2- Trichloroethane
- 1,1,2,2- Tetrachloroethane
- Chloroethane
- 2-Chloroethyl vinyl ether (mixed)
- Chloroform (trichloromethane)
- 1,2-Dichlorobenzene
- 1,3-Dichlorobenzene
- 1,4- Dichlorobenzene
- 1,1-Dichloroethylene
- 1,2-Trans-dichloroethylene
- 1,2- Dichloropropane
- 1,3- Dichloropropylene (cis 1,3 dichloropropene)
- trans 1,3 dichloropropene
- Methylene chloride (dichloromethane)
- Methyl chloride (chloromethane)
- Methyl bromide (bromomethane)
- Bromoform (tribromomethane)
- Dichlorobromomethane
- Chlorodibromomethane
- Trichloroethylene
- Vinyl chloride (chloroethylene)
- cis-1,2-dichloroethene