

Redacted

August 3, 2020

To Whom It May Concern,

I am the homeowner at **Redacted** in Santa Rosa, and I have lived at this address for over 7 years. I am a working professional, a busy mother, and have never made a complaint about a neighbor in my life. This issue has caused much discord between my spouse and me.

Since mid-March I have worked from home full-time due to COVID/Shelter In Place, while taking care of my young children. I have only left my house a handful of times over 4 months out of concern about COVID. Approximately two and a half weeks ago, I briefly left my house and was absolutely appalled to see that **Redacted** 1900 Brush Creek Road had very quickly built an extension attached to their existing home (approximately 10x25 foot addition on a poured concrete foundation, which is still being built). The new addition has extended the existing home all the way through their property set-back, and it now abuts a private road (a shared driveway), of which they are not an owner. This has destroyed the natural and rural characteristics of my once private, scenic driveway, which is on Brush Creek Road (see attached photos and grant deed).

My concerns are the following:

(1) a violation of the property set-back with an unpermitted addition on a poured foundation that is still being built, (2) a potential violation of the Brush Creek Road scenic road set-back (*Scenic Road Zoning code 20-28.050 Scenic Road (-SR) combining district* (sections A-G), (3) a potential violation of the private driveway and public utility easement, (4) removal of two approximately 80-100 foot by 5 foot in diameter redwood trees, and (5) no permits and no notice to city planning/zoning commission, neighbors, etc. Had I been aware of the actual plan, or had there been any discussion with me, I would never have approved a new addition to be built at the entry of our driveway, as it erodes our privacy and home value. Furthermore, the addition does not meet any guidelines for a variance.

I request that the Santa Rosa Planning Commission address this matter expeditiously and require the homeowners at 1900 Brush Creek Road rectify this knowing and willful disregard for the City's building and zoning codes **with the complete removal of the new addition in its entirety**. It adversely affects the community through a blatant disregard for the preservation of Scenic Road requirements and disregards the neighbors on the shared driveway, who have lost privacy and enjoyment of their driveway due to a home now abutting the driveway easement. This will also likely reduce property values for the homes at the end of the shared driveway and who are owners of the private drive. Lastly, this potentially creates an issue whereby a foundation may have been poured over existing utility access points (utilities for the three homes at the end of the driveway), and it may be a fire issue as well.

The homeowner at 1900 Brush Creek moved into the home 1 year ago and is knowledgeable about construction with much heavy equipment. I believe that this was not an oversight, but a willful disregard for the set-backs. I believe other neighbors in the vicinity may not have been aware of the construction due to COVID, or they would have assumed that the work was permitted and/or to code.

Sincerely,

Redacted

Before and After: 1900 Brush Creek Road (change from April to July 2020, ~ 4 months)



Extension of pre-existing home through its property set-back and to the private driveway of which the homeowners are not an owner **(See attached grant deed and parcel maps No. 609).**

Home addition/extension beyond the Scenic Brush Creek set-back. **(See attached parcel map No. 609, p. 635-7).**

Light on the front of the home provides a point of reference for the addition

To my knowledge, no permits were obtained for this work. No plans were ever discussed or shared with me, and I was under the impression it was a bathroom re-model with a permit.

During this time, I was working from home full-time and did not leave my front door more than a few times due to concern about COVID. I was shocked and completely appalled seeing this addition approximately two weeks ago, when I left my house for an errand.

(photos from Brush Creek Road facing **Redacted** driveway)

Before and After: 1900 Brush Creek Road, along the shared driveway (~April vs. July 2020)



The privacy and rural character of the shared driveway is negatively impacted because the addition has violated the residential set back and scenic Brush Creek requirements. The set back is in place to preserve these characteristics

Ruralness/rustic charm/privacy of Scenic Brush Creek and the flag lot homes on this shared driveway are grossly diminished

The financial harm to the flag lots is the loss of privacy, charm and value of living in a rural setting close to downtown. There is also potential loss in resale value.

A bedroom and bathroom now abut the driveway easement such that walking to the mailbox on the road feels uncomfortable and intrusive because it is steps away from a bathroom and bedroom

The redwood trees and tree canopy were removed in order to extend the home approximately 10 feet through the set-back. This likely also violates the Scenic Road set-back for Brush Creek Road

Before and After from mailboxes on road and turn into our driveway

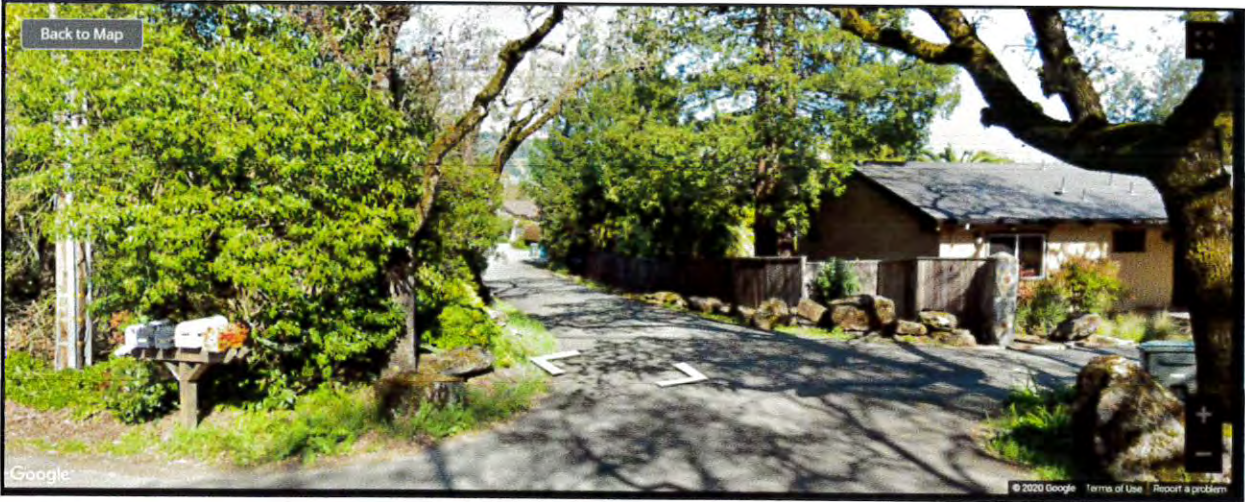

Entry to driveway taken at spring / summer – when the privacy screen is at its best with maximum foliage.

Walking up to or stopping at mailboxes feels intrusive and uncomfortable

The driveway was stripped of its serene, hidden/private charm due to the bright white extension up to the driveway.



View up the **Redacted** driveway toward Brush Creek Road and to the mailboxes.



BEFORE photos showing the privacy and seclusion enjoyed by the homeowners. Most passers-by on scenic Brush Creek Road would not even know this was a driveway into four homes

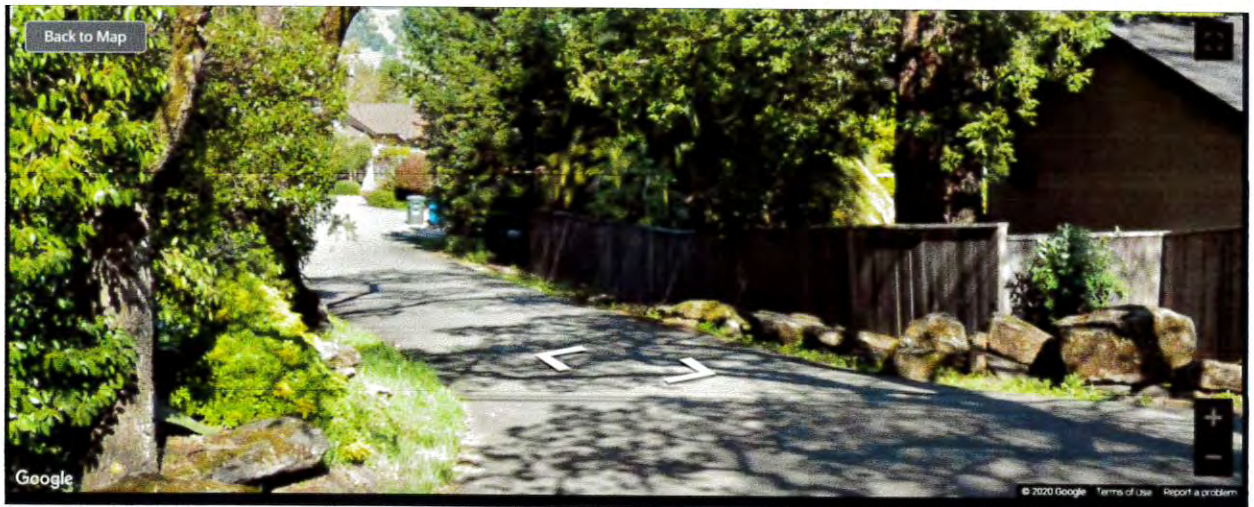



View into driveway as of July 31, 2020 from scenic Brush Creek Rd.

The driveway feels sterilized and stripped of the privacy, uniqueness and idyllic country-charm that had made it special for many years.

Some mature trees were dropped (including 1-2 approx. 80-100 foot redwoods), which had provided privacy to the shared driveway; the addition/extension was then built very quickly with no sharing of plans or discussion, which is now essentially “on the driveway.”

This is an upsetting situation, as most of the work has personally been completed by the owner, who is a deputy sheriff, a veteran, and I believe may even be a contractor as well. The family moved into the home approximately one year ago and has been very friendly to all the neighbors.

That said, if not addressed and remedied immediately, I am very concerned that (1) there will be no meaningful remedy to correct this blatant loss of privacy and tranquility **Redacted** as well as potential loss of home value caused by a knowing and blatant disregard for the property set-back and Brush Creek scenic road set-back, which are in place to protect the unique characteristics of Brush Creek Road and the homes on this driveway, and (2) further expansion and construction beyond property set-backs and additional removal of trees (to include a large oak tree on the property, which provides a significant screen to the road, see attached photograph of oak tree) will likely occur without any notice, permits, sharing of plans, etc. There appears to be preparation for a new fence at this time.

I am not a difficult neighbor, but a quiet professional, who has never made a complaint about a neighbor in my life. I feel taken advantage of and wish that I was not placed in this position. But I cannot allow their desire to better themselves or improve their own square footage/home value to diminish what I have also worked very hard to attain.

The homeowners could have extended their home in a different manner within the allowed set-backs of their lot. This is a deliberate, opportunistic land grab, as building differently would have gone into their own yard or driveway. It was not driven by any hardship that would have justified a variance. The homeowners were aware of the set back (as a skilled contractor) and had direct notice of the set-backs, as their grant deed showing the lot lines was signed just one year ago in July 2019 (see attached).

I did not know that the homeowners were going to build beyond their allowed space, did not know there were no permits, was never approached to discuss their plans and never would have approved it.

Redacted

8/3/2020
Date



Back yard of 1900 Brush Creek showing large, healthy oak tree / privacy screen (noted previously) and the area next to the existing structure, where the owners could have potentially added onto their home, instead of into the set-back.

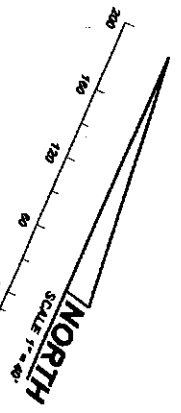
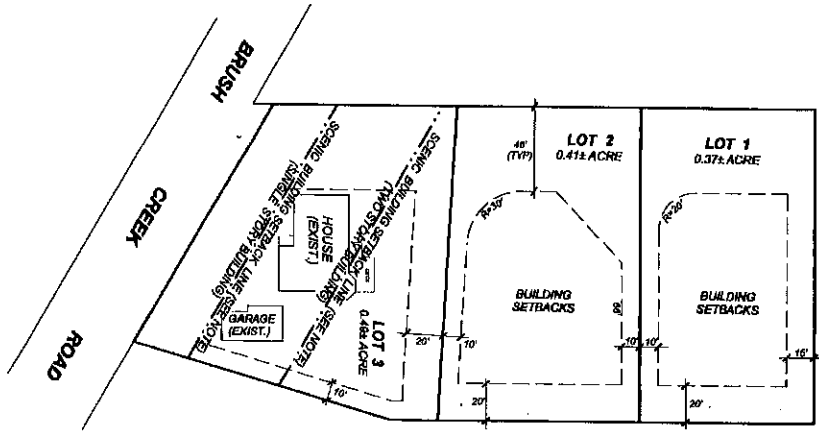

SCENIC BUILDING SETBACK NOTE:
 FRONT SETBACKS FOR ONE STORY STRUCTURE SHALL BE 10 FEET FROM THE SCENIC BUILDING SETBACK LINE AND 100 FEET FOR TWO STORY PORTION OF THE STRUCTURE

- NOTES:**
- 1) THIS SHEET IS FOR INFORMATION PURPOSES ONLY. DESCRIBING CONDITIONS AS OF PLUMB AND IS NOT INTENDED TO AFFECT RECORDING INTEREST.
 - 2) DEMAND FEES, METER INSTALLATION FEES, AND PROCESSING FEES REQUIRED BY THE CITY MUST BE PAID BY THE APPLICANT PRIOR TO ISSUANCE OF A BUILDING PERMIT.
 - 3) THIS INFORMATION IS DERIVED RECORDS AND REPORTS AND DOES NOT IMPLY THE CORRECTNESS OR SUFFICIENCY OF THESE RECORDS BY THE PREPARED BY THIS DOCUMENT.
 - 4) THIS PROJECT IS SUBJECT TO THE LATEST ADOPTED ORDINANCES, RESOLUTIONS, POLICIES AND FEES FOR THE CITY OF SONOMA. ALL APPLICANTS SHALL BE REQUIRED TO PARTICIPATE IN THE CITY COUNCIL AT THE TIME OF THE BUILDING PERMIT REVIEW AND APPROVAL.
 - 5) A PUBLIC EASEMENT SHALL BE PROVIDED FOR PUBLIC UTILITY LINES OUTSIDE THE PROPERTY BOUNDARIES. THE EASEMENT SHALL BE EQUAL TO TWICE THE DEPTH OF THE MAIN OR WATER MAIN AND SHALL BE EQUAL TO TWICE THE DEPTH OF THE MAIN OR WATER MAIN AND SHALL BE CENTERED OVER THE FACILITY. THE EASEMENT SHALL BE COMPLETED TO INCLUDE ALL PUBLICLY MAINTAINED APPURTENANCES AND STRUCTURES. NO SURFACE STRUCTURE INCLUDING EASEMENT, FOOTING AND FOUNDATIONS OR PILES MAY ENCLOSE INTO THE EASEMENT. FOOTING AND FOUNDATIONS SHALL BE APPROVED IN WRITING BY THE CHIEF BUILDING OFFICIAL AND THE DIRECTOR OF UTILITIES.
 - 6) REDUCTION IN THE EASEMENT WIDTH MAY BE ALLOWED WITH WRITTEN APPROVAL BY THE DIRECTOR OF UTILITIES. THE EASEMENT SHALL NOT BE PLACED WITHIN 10' OF A PUBLIC SEWER MAIN. THE CITY UTILITIES DEPARTMENT WILL NOT BE RESPONSIBLE FOR REPAIRS OR REPLACEMENT OF LANDSCAPING IN PUBLIC SEWER MAIN EASEMENTS.
 - 7) THE STATIC WATER PRESSURE FOR THIS PROJECT IS APPROXIMATELY 80.00 PSI. INDIVIDUAL PRESSURE REGULATORS ARE REQUIRED ON ALL LOTS.
 - 8) LOTS 1, 2 AND 3 ARE SUBJECT TO A JOINT MAINTENANCE AND ACCESS DECLARATION TO BE RECORDED CONCURRENTLY WITH THE MAP.

**"SUPPLEMENTAL INFORMATION AFFECTING"
 PARCEL MAP NO. 609**

LANDS OF MICHAEL G. DEHNERT AND SHARON T. DEHNERT,
 PER DOC. NO. 1988-0156878 SONOMA COUNTY RECORDS,
 BEING A PORTION OF RANCHO CABEZA DE SANTA ROSA

4 LOTS, 1.27 ACRES
 CITY OF SANTA ROSA COUNTY OF SONOMA
 STATE OF CALIFORNIA

MIKE BLITI
 LAND SURVEYOR
 SONOMA, CALIFORNIA
 MAY 20, 2001

635

7

MONTECITO VILLAGE NO. 1
92 MAPS 29 & 30 SCR

MONTECITO VILLAGE NO. 2
92 MAPS 29 & 30 SCR

GLEN OAKS SUBDIVISION
UNIT NO. 2
224 MAPS 7 & 9 SCR

PARCEL MAP NO. 242
266 MAPS 40 & 41 SCR

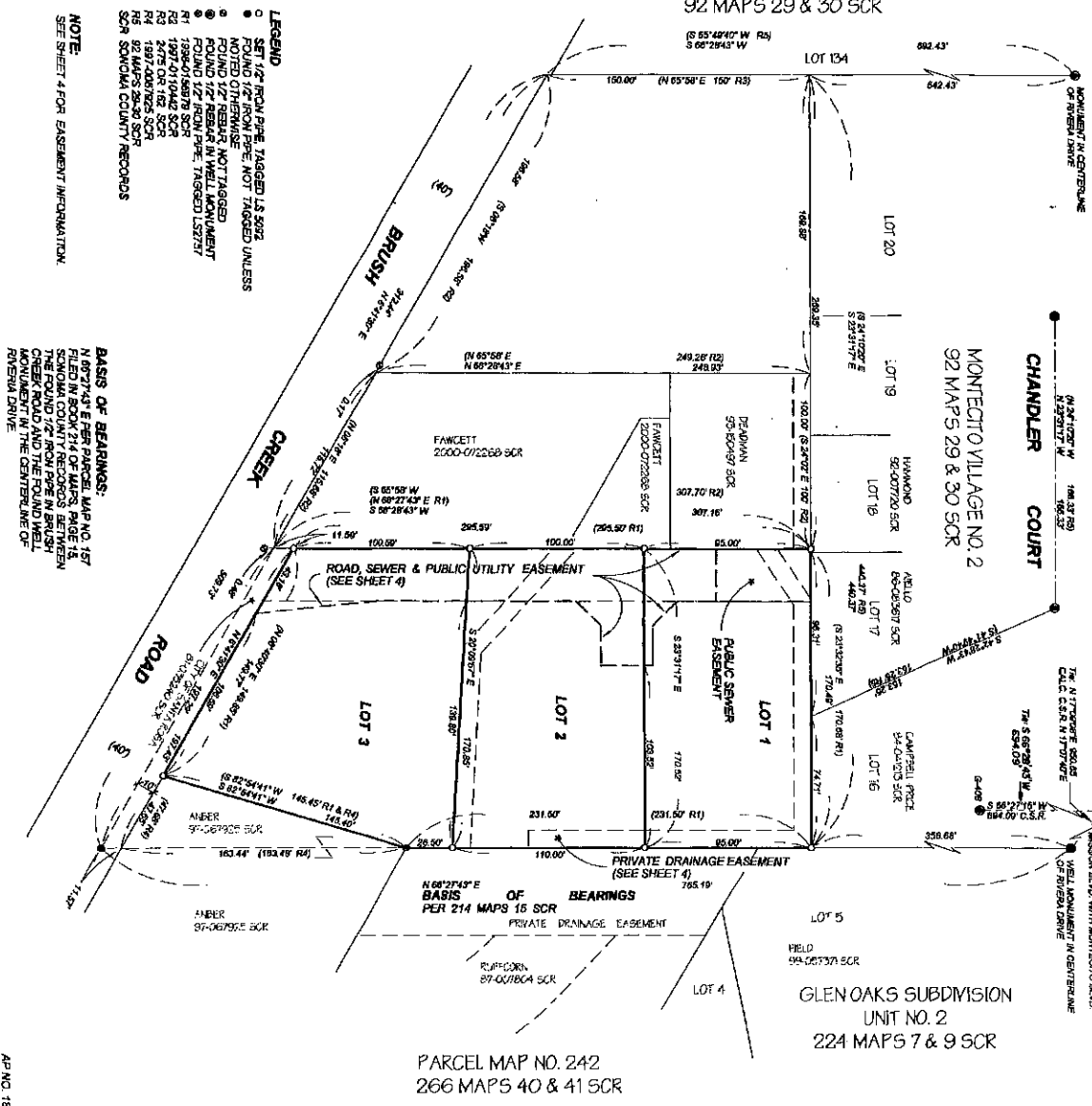

LEGEND

- SET 1/2" IRON PIPE, TAGGED LS 5012
- FOUND 1/2" IRON PIPE, NOT TAGGED UNLESS NOTED OTHERWISE
- FOUND 1/2" REBAR, NOT TAGGED UNLESS NOTED OTHERWISE
- FOUND 1/2" REBAR, TAGGED UNLESS NOTED OTHERWISE
- FOUND 1/2" IRON PIPE, TAGGED UNLESS NOTED OTHERWISE
- FOUND 1/2" IRON PIPE, TAGGED UNLESS NOTED OTHERWISE
- FOUND 1/2" IRON PIPE, TAGGED UNLESS NOTED OTHERWISE
- FOUND 1/2" IRON PIPE, TAGGED UNLESS NOTED OTHERWISE
- FOUND 1/2" IRON PIPE, TAGGED UNLESS NOTED OTHERWISE
- FOUND 1/2" IRON PIPE, TAGGED UNLESS NOTED OTHERWISE
- FOUND 1/2" IRON PIPE, TAGGED UNLESS NOTED OTHERWISE
- FOUND 1/2" IRON PIPE, TAGGED UNLESS NOTED OTHERWISE
- FOUND 1/2" IRON PIPE, TAGGED UNLESS NOTED OTHERWISE
- FOUND 1/2" IRON PIPE, TAGGED UNLESS NOTED OTHERWISE

NOTE:
SEE SHEET 4 FOR EASEMENT INFORMATION.

PARCEL MAP NO. 609
LANDS OF MICHAEL S. DENHART AND SHARON J. DENHART,
PER DOC NO. 19980158979 SONOMA COUNTY RECORDS,
BEING A PORTION OF RANCHO CABEZA DE SANTA ROSA
4 LOTS, 1.27 ACRES
CITY OF SANTA ROSA COUNTY OF CALIFORNIA
LAND SURVEYOR
MIKE BLITT
SONOMA
MAY 30, 2001

LOCATION MAP
(NOT TO SCALE)

CITY OF SANTA ROSA HORIZONTAL
CONTROL MONUMENTS
(1/2" REBAR IN WELL MONUMENTS)
G-408 N 794.360
E 1,200.000
G-409 N 844.457
E 1,000.000

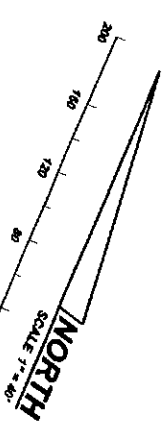

AP NO. 182-140-035

TENTATIVE MAP FILE NO. 08N99-005

SHEET 2 OF 4

035

5

EXHIBIT "A"
Legal Description

For APN/Parcel ID(s): 182-140-056-000

THE LAND REFERRED TO HEREIN BELOW IS SITUATED IN THE CITY OF SANTA ROSA, COUNTY OF SONOMA, STATE OF CALIFORNIA AND IS DESCRIBED AS FOLLOWS:

PARCEL ONE:

LOT 3 AS SHOWN ON PARCEL MAP NO. 809 CITY OF SANTA ROSA, FILED JUNE 11, 2002, IN BOOK 636 OF MAPS, PAGES 4-7, SONOMA COUNTY RECORDS.

PARCEL TWO:

A PRIVATE DRAINAGE EASEMENT DESCRIBED AS FOLLOWS: BEGINNING AT THE NORTHWESTERLY CORNER OF LOT NUMBER 8 AS SHOWN ON THE FINAL MAP FOR GLEN OAKS SUBDIVISION UNIT NUMBER 2, AS RECORDED IN BOOK 224 OF MAPS, PAGES 7 THROUGH 9 INCLUSIVE, SONOMA COUNTY RECORDS; THENCE NORTH 66° 27' 43" EAST, 140.00 FEET TO POINT "A"; THENCE NORTH 6° 27' 43" EAST, 61.18 FEET; THENCE SOUTH 07° 32' 00" WEST, 58.38 FEET; THENCE SOUTH 66° 27' 43" WEST, 109.54 FEET; THENCE NORTH 06° 18' 00" EAST, 5765 FEET TO THE POINT OF BEGINNING.

PARCEL THREE:

A PRIVATE DRAINAGE EASEMENT WHICH LIES 20 FEET EASTERLY AND 30 FEET WESTERLY OF THE FOLLOWING DESCRIBED LAND: BEGINNING AT POINT "A" REFERRED TO IN PARCEL THREE HEREIN; THENCE SOUTH 20° 15' 00" WEST, 99.77 FEET; THENCE ON A TANGENT CURVE TO THE RIGHT HAVING A RADIUS OF 1300.00 FEET AND AN INTERNAL ANGLE OF 24° 30' 00" THENCE ALONG SAID CURVE 55.59 FEET; THENCE SOUTH 44° 46' 00" WEST, 7.52 FEET; THENCE ON A TANGENT CURVE TO THE LEFT HAVING A RADIUS OF 130.00 FEET AND AN INTERNAL ANGLE OF 112° 24' 59" THENCE ALONG SAID CURVE 255.07 FEET; THENCE SOUTH 87° 39' 59" EAST, 32.97 FEET TO THE WESTERLY LINE OF LOT 3 AND SAID LOT 3 IS SHOWN UPON THE MAP OF GLEN OAKS SUBDIVISION UNIT NUMBER 2; THENCE CONTINUING SOUTH 67° 39' 59" EAST, TO THE SOUTHERLY LINE OF THE AFOREMENTIONED LOT 3 AND THE POINT OF TERMINATION OF THE LINE HEREIN DESCRIBED.

From: [Kathleen Parnell](#)
To: [Maystrovich, Mark](#)
Subject: [EXTERNAL] Re: 1900 Brush Creek Road
Date: Monday, August 10, 2020 10:21:48 AM
Attachments: [1900 Brush Creek Road Email attachments_081020.pdf](#)

Mark,

Thank you for getting back to me. I learned additional information regarding the build at 1900 Brush Creek Road (Lichau residence) that you and City officials should be aware of.

<!--[if !supportLists]-->1. <!--[endif]-->Dan Lichau is a licensed General Contractor (license #1065989) and his license is under Lidoli Corporation – See attached.

<!--[if !supportLists]-->2. <!--[endif]-->Dan Lichau is the CEO of Lidoli Corporation, which is his construction company – See attached.

<!--[if !supportLists]-->3. <!--[endif]-->Lidoli Corporation's principal address is 1900 Brush Creek Road – See attached.

<!--[if !supportLists]-->4. <!--[endif]-->One of Dan Lichau's business partners at Lidori Corp. includes a construction attorney at a large law firm in San Francisco

If a licensed contractor/Deputy Sheriff/construction business owner is allowed to build ignoring permit requirements and zoning codes (property set-backs, scenic road set-backs, heritage tree removal rules for a scenic road, etc.) to enrich himself at the expense of others, then what effective deterrent does the City have? I believe this was a greedy land grab during a pandemic by a Deputy Sheriff, who is a licensed contractor, who took advantage of the naiveté and trust of his neighbors.

This addition added approximately \$175k to his home value (with an expanded, high-end master bath, walk-in closet and additional bedroom). In my opinion, any fine or fees less than the incremental value, or allowing the addition to remain in tact, makes violating the law financially lucrative and could possibly show preferential treatment by the City of Santa Rosa to a Deputy Sheriff. Neighbors trusted Dan Lichau because he is a Deputy Sheriff and assumed he was not breaking any civil/criminal laws, civil codes or set-backs.

Dan Lichau worked through the pandemic with several licensed contractors despite the state and local emergency quarantine orders. This is not a fire re-build.

The following is also information that I learned:

Possible Safety Issue / Water:

Dan Lichau excavated and exposed the water lines from the city hook-up on our utility easement using an excavator that he owns. I learned that water was turned off to the three homes at the end of **Redacted** driveway for a period of time while these water

lines were excavated/exposed in preparation for the addition over the set-back. A neighbor thought the City of Santa Rosa had shut off her water one day. She called the City and was told that there were no issues. She then went up the [Redacted] driveway to see if any work was being done on Brush Creek Rd. She saw Dan Lichau working, asked him about the water, and he told her that he shut off the water in order to plant a new olive tree. On information and belief, Dan Lichau accessed our city water (pipes) and may have damaged/repared, altered, re-plumbed, or moved the water lines to facilitate his new addition over the set-back. There are other utilities in the utility easement, which includes sewer, PG&E and water.

Dan Lichau had no reason to excavate, access or shut off my water and my neighbors' water from the City because he is on a separate water line.

I am concerned about the safety of our City water because he apparently worked on our water line and accessed our utilities easement in secret.

Possible Safety Issue / Fire:

The new structure now abuts the driveway, as you probably observed. I feel this may now create a safety hazard with respect to fire because it could possibly hinder [Redacted] ability to escape onto Brush Creek Road (as we did in 2017 during the Tubbs Fire), or hinder the Fire Department's access [Redacted] the end of the driveway if necessary. [Redacted]

Extensive Excavation Work and More Throughout Property:

Lastly, Dan Lichau has done extensive excavation and work throughout the entire property (outdoor electrical, movement of the pool equipment, new plumbing, HVAC, 7 to 8' iron gate, burying of culverts to re-direct water, heritage tree removal and more). This work was all also done without permits.

(See attached photos of Dan Lichau on his excavator on 5/8/20, which I took [Redacted] [Redacted]. Also see attached photo of the redwood/heritage tree that was cut down to make room for his home addition).

Please let me know who my point of contact will be going forward (if someone other than yourself), and whether I will be advised of the status of permits, variance requests, etc. I would like to oppose any variance request or possible allowance of the City that would enable the addition over the set-back to remain.

If you have any questions or concerns, please contact me any time at [Redacted] [Redacted]

Kind regards,

[Redacted]

On Thursday, August 6, 2020, 01:33:16 PM PDT, Maystrovich, Mark <mmaystrovich@srcity.org> wrote:

Good Afternoon

Thank you for your updates

I was at the property this morning and spoke with the owners. This project is complete and they are now painting the interior. I have also made contact with several other persons involved on this property. They all have been directed to obtain all necessary approvals, permits and inspections for tis project

Mark

Mark Maystrovich |Senior Code Enforcement Officer

Planning and Economic Development |100 Santa Rosa Avenue | Santa Rosa, CA 95404

Tel. (707) 543-3268 | Fax (707) 543-4315 | mmaystrovich@[srcity.org](mailto:mmaystrovich@srcity.org)

Hello and thank you for your email. Please note: The City of Santa Rosa has closed most of its public counters until further notice to help curb a resurgence of coronavirus infections occurring in Sonoma County and statewide. Access to most City services remains available online, by phone, and in some instances in-person by appointment. For a current list of those services, visit srcity.org/ServiceFinder.

For detailed information about the City of Santa Rosa's ongoing response the coronavirus public health emergency, please visit the City's website at srcity.org/PreventTheSpread



From: [Redacted]
Sent: Thursday, August 6, 2020 10:37 AM
To: Maystrovich, Mark <MMaystrovich@srcity.org>
Subject: [EXTERNAL] Re: 1900 Brush Creek Road

Hi Mark,

Work continues on this project today (1900 Brush Creek Road). Just a heads up.

Kind regards,

[Redacted]

On Wednesday, August 5, 2020, 11:10:45 AM PDT, [Redacted] wrote:

Hi Mark,

It appears that work is in progress at the property now. I just wanted to make you aware.

Thank you,

[Redacted]

On Wednesday, August 5, 2020, 9:21:10 AM PDT, [Redacted] wrote:

Hi Mark,

I dropped off a complaint yesterday at the City regarding 1900 Brush Creek Road and understand that you have been assigned to this matter. I live at 1888 Brush Creek

Road, which is next door.

I wanted to confirm that you received my complaint, **and** also wanted to let you know that my spouse notified the neighbor at 1900 Brush Creek this morning that I filed a complaint with the City (as he felt it was the right thing to do to so the neighbor wouldn't be surprised). The neighbor was previously not aware, so I wanted to let you know this, in case you have not yet been by the property.

Please let me know what your next steps are and feel free to reach me anytime on my cell **Redacted**

Kind regards,

Redacted

▼ Personnel License List for LICHAU, DANIEL PATRICK ✓

Click on the license number to see a more detailed page of information on that person.

Licenses Currently Associated With

✓
✓ **License #** 1065989
Business Name LIDOLI CORP
City SAN RAFAEL
Association Date 05/22/2020
Status ACTIVE

[Back to Top](#) [Conditions of Use](#) [Privacy Policy](#) [Accessibility](#) [Accessibility Certification](#)

Copyright © 2020 State of California



California Secretary of State
Electronic Filing

FILED

Secretary of State
State of California

Corporation - Statement of Information

Entity Name: LIDOLI, CORP. ✓

Entity (File) Number: C4567706

File Date: 08/02/2020

Entity Type: Corporation

Jurisdiction: CALIFORNIA

Document ID: GH46774

Detailed Filing Information

1. Entity Name: LIDOLI, CORP. ✓

2. Business Addresses:

a. Street Address of Principal Office in California: 1900 Brush Creek Rd ✓
Santa Rosa, California 95404
United States of America

b. Mailing Address: 1900 Brush Creek Rd
Santa Rosa, California 95404
United States of America

c. Street Address of Principal Executive Office: 1900 Brush Creek Rd ✓
Santa Rosa, California 95404
United States of America

3. Officers:

a. Chief Executive Officer: Daniel Patrick Lichau ✓
1900 Brush Creek Rd
Santa Rosa, California 95404
United States of America

b. Secretary: Philip John Downs
1900 Brush Creek Rd
Santa Rosa, California 95404
United States of America

Document ID: GH46774



California Secretary of State Electronic Filing

Officers (cont'd):

c. Chief Financial Officer:

Mikkel Labourdette Libarle
1900 Brush Creek Rd
Santa Rosa, California 95404
United States of America

4. Director:

Daniel Patrick Lichau
1900 Brush Creek Rd
Santa Rosa, California 95404
United States of America

Number of Vacancies on the Board of
Directors:

0

5. Agent for Service of Process:

Philip John Downs Jr.
57 Elm Ave.
San Anselmo, California 94960
United States of America

6. Type of Business:

General Contractor

By signing this document, I certify that the information is true and correct and that I am authorized by California law to sign.

Electronic Signature: Philip John Downs, Jr.

Use bizfile.sos.ca.gov for online filings, searches, business records, and resources.

Document ID: GH46774



California Secretary of State Electronic Filing

Corporation - Attachment to Statement of Information

List of Additional Directors:

1. Philip John Downs
1900 Brush Creek Rd
Santa Rosa, California 95404
United States of America
2. Mikkell Labourdette Libarle
1900 Brush Creek Rd
Santa Rosa, California 95404
United States of America
- 3.
- 4.
- 5.
- 6.
- 7.

Document ID: GH46774

4567706



Secretary of State
Articles of Incorporation with Statement of Conversion -
California Limited Liability Company to a California Stock Corporation

CONV LLC-GS

FILED
Secretary of State
State of California
FEB 18 2020

IMPORTANT - Read instructions before completing this form.

Filing Fee - \$150.00

Copy Fees - First page \$1.00; each attachment page \$0.50;
Certification Fee - \$5.00

Note: Most corporations have to pay a minimum \$800 tax to the California Franchise Tax Board each year. For more information, go to <https://www.ftb.ca.gov>.

IPC This Space For Office Use Only

1. Name of Converted California Corporation (Go to www.sos.ca.gov/business/be/name-availability for general corporate name requirements and restrictions.)

The name of the converted California corporation is LIDOLI, Corp.

2. Business Addresses of the Converted California Corporation (Enter the complete business addresses.)

a. Initial Street Address of Corporation - Do not list a P.O. Box. <u>219 Mirada Ave</u>	City (no abbreviations) <u>San Rafael</u>	State <u>CA</u>	Zip Code <u>94903</u>
b. Initial Mailing Address of Corporation, if different than item 2a.	City (no abbreviations)	State	Zip Code

3. Service of Process (Must provide either Individual OR Corporation.)

INDIVIDUAL - Complete Items 3a and 3b only. Must include agent's full name and California street address.

a. California Agent's First Name (if agent is not a corporation). <u>Philip</u>	Middle Name <u>J</u>	Last Name <u>Dawns</u>	Suffix <u>Jr.</u>
b. Street Address (if agent is not a corporation) - Do not enter a P.O. Box. <u>219 Mirada Ave.</u>	City (no abbreviations) <u>San Rafael</u>	State <u>CA</u>	Zip Code <u>94903</u>

CORPORATION - Complete Item 3c. Only include the name of the registered agent Corporation.

c. California Registered Corporate Agent's Name (if agent is a corporation) - Do not complete Item 3a or 3b.

4. Shares (Enter the number of shares the corporation is authorized to issue. Do not leave blank or enter zero (0).)

This corporation is authorized to issue only one class of shares of stock.
The total number of shares which this corporation is authorized to issue is 10 million

- CONTINUE ON NEXT PAGE -

(Page 1 of 2)

Articles of Incorporation with Statement of Conversion
California Limited Liability Company to a California Stock Corporation
(Page 2 of 2)

4567706

5. Purpose Statement (Do not alter the Purpose Statement.)

The purpose of the corporation is to engage in any lawful act or activity for which a corporation may be organized under the General Corporation Law of California other than the banking business, the trust company business or the practice of a profession permitted to be incorporated by the California Corporations Code.

6. Statement of Conversion for the California Limited Liability Company

6a. The name of the converting California limited liability company is DXP Industries, LLC

6b. The limited liability company's California Secretary of State file number is 201912810259

6c. The principal terms of the plan of conversion were approved by a vote of the members, which equaled or exceeded the vote required under California Corporations Code section 17710.03. There is one class of members entitled to vote and the percentage vote required is a majority in interest of the members. The limited liability company is converting into a California stock corporation.

7. Read, Declare and Sign Below. Do not use computer generated signature. (See instructions for signature requirements.)

Additional article provisions set forth on attached pages, if any, are incorporated herein by reference and made part of this Form CONV LLC-GS. (All attachments should be 8 1/2 x 11, one-sided, legible and clearly marked as an attachment to this Form CONV LLC-GS.)

I declare that I am the person who signed this instrument, which is my act and deed.

Signature of Member or Manager

Philip John Downs, Jr. Member or Manager of
Type or Print Name

DXP Industries, LLC and Incorporator.
Enter Name of converting California LLC



Signature of Member or Manager

Daniel Patrick Lichao Member or Manager of
Type or Print Name

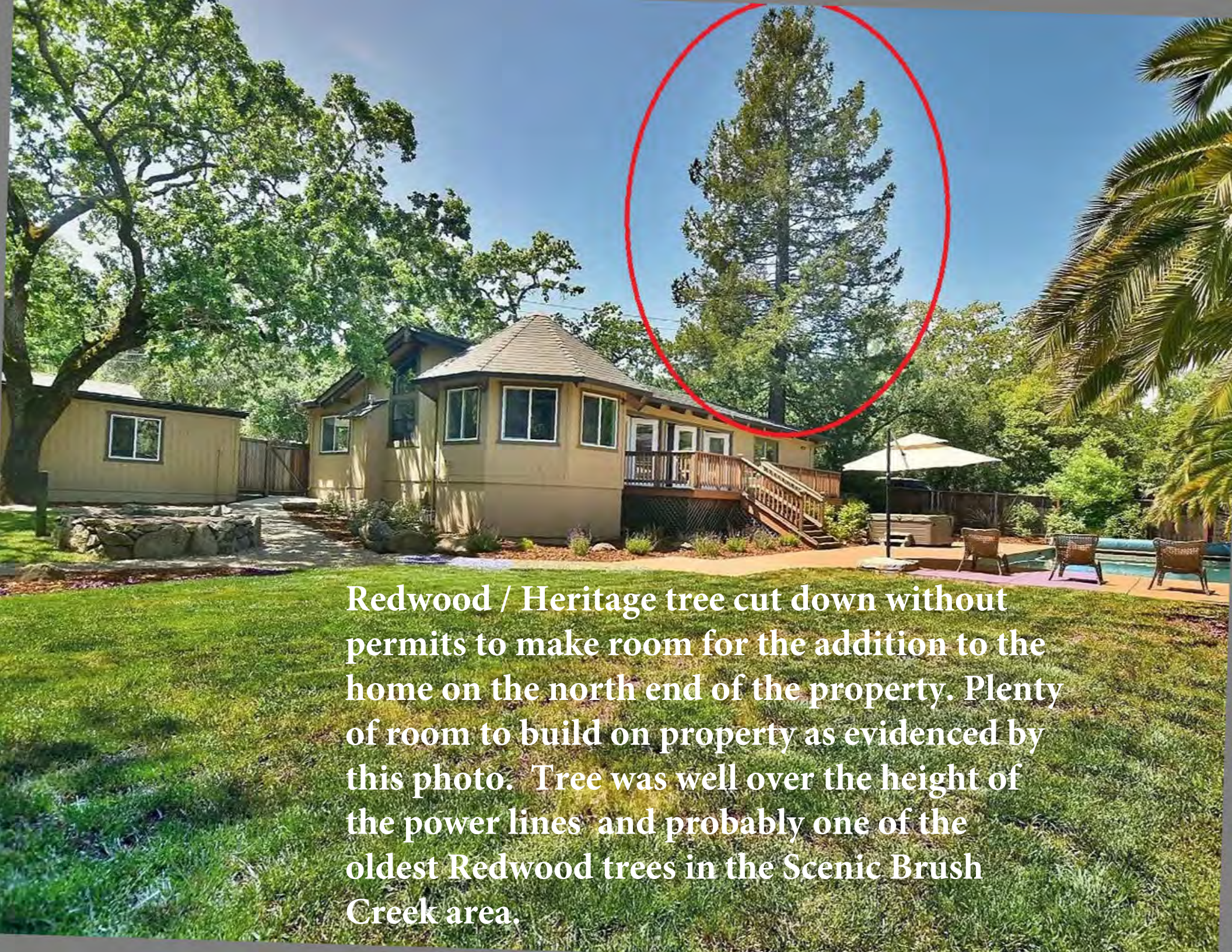
DXP Industries, LLC and Incorporator.
Enter Name of converting California LLC

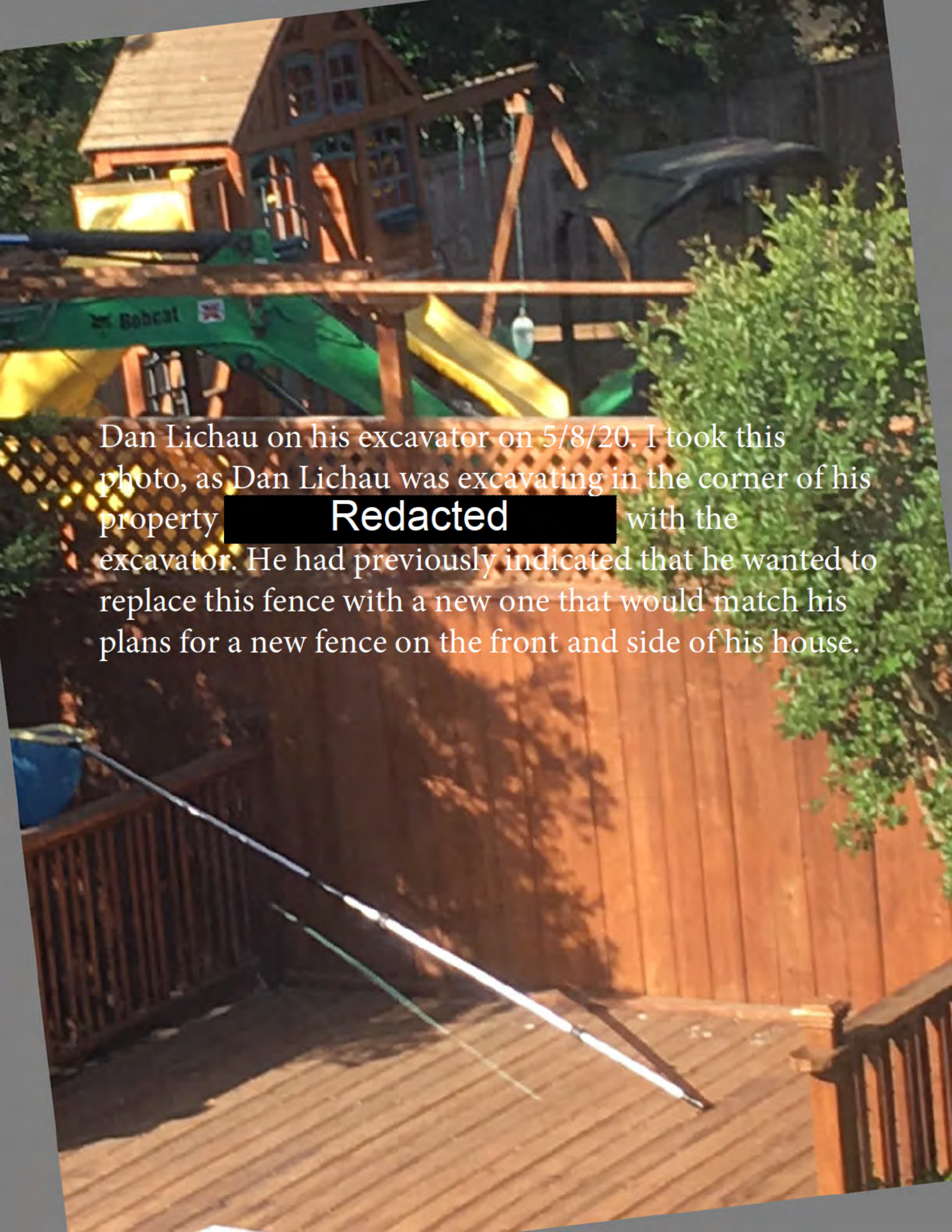

Redwood / Heritage tree cut down without permits to make room for the addition to the home on the north end of the property. Plenty of room to build on property as evidenced by this photo. Tree was well over the height of the power lines and probably one of the oldest Redwood trees in the Scenic Brush Creek area.



Dan Lichau on his excavator on 5/8/20. I took this photo, as Dan Lichau was excavating in the corner of his property **Redacted** with the excavator. He had previously indicated that he wanted to replace this fence with a new one that would match his plans for a new fence on the front and side of his house.



Dan Lichau on his excavator on 5/8/20 while digging trenches for culverts placed underground to re-direct water. [Redacted]

[Redacted] (within a short time of Dan Lichau indicating that he had wanted to take down our fence to replace it with a new one that would match his plans for a new fence in the front and side of his property).

Date: 8/13/2020

To: City of Santa Rosa Planning Department

From: [Redacted]

Re: 1900 Brush Creek Rd. – Illegal build, unpermitted work, set-back violations, etc.

Brief Background

On August 3, 2020, I filed a complaint with the City of Santa Rosa regarding an unpermitted addition to the home at 1900 Brush Creek Road (approximately 350-400 square feet) on a poured, concrete foundation, which extended the home entirely through the property set-back and into the Scenic Road set-back.

The owner is now being required by the City to seek necessary approvals, permits and inspections. I feel any permit request should be **denied**, as this structure/extension into the set-backs would not have been granted permits for construction had permits been requested prior to the build.

Moreover, the fence was removed along [Redacted] driveway, and now the new addition not only abuts the [Redacted] driveway, but the house now serves as the fence! This addition took the place of a fence on my driveway. If a fence cannot exceed 6 feet, then how can a house being used in lieu of a fence be permitted over 6 feet?

New Information

Since filing my complaint, I learned additional information regarding the build at 1900 Brush Creek Road (Lichau residence) that City officials should be aware of.

1. Dan Lichau is a licensed General Contractor (license #1065989) and his license is under Lidoli Corporation – See attached.
2. Dan Lichau is the CEO of Lidoli Corporation, which is his construction company – See attached.
3. Lidoli Corporation's principal address is 1900 Brush Creek Road – See attached.
4. One of Dan Lichau's business partners at Lidori Corp. includes a construction attorney at a large law firm in San Francisco

If a licensed contractor/Deputy Sheriff/construction business owner is allowed to build ignoring permit requirements and zoning codes (property set-backs, scenic road set-backs, heritage tree removal rules for a scenic road, etc.) to enrich himself at the expense of others, then what effective deterrent does the City have? I believe this was a greedy land grab during a pandemic by a Deputy Sheriff, who is a licensed contractor, who took advantage of the naiveté and trust of his neighbors.

This addition added approximately \$175k to his home value (with an expanded, high-end master bath, walk-in closet and additional bedroom). Allowing the addition to remain intact makes violating the law financially lucrative and could possibly show preferential treatment by the City of Santa Rosa to a Deputy Sheriff.

Neighbors trusted Dan Lichau because he is a Deputy Sheriff, and they assumed he was not breaking civil/criminal laws, civil codes or set-backs. His take-home patrol car is parked in his driveway every day.

Dan Lichau worked through the pandemic on his home with several licensed contractors, despite the state and local emergency quarantine orders. This was not a fire re-build. It was a planned addition during the shelter-in-place order, which required dropping an estimated 100 year-old redwood tree (heritage tree – See attached photo), new plumbing, new electrical, HVAC, pouring foundation, framing, roofers, etc. Dan Lichau is a licensed contractor and a construction business owner. He knows what he is doing.

The following is also information that I learned since filing my initial complaint:

Possible Safety Issue / Water

In February, Dan Lichau engaged in extensive excavation in my utilities easement while he was building his large, iron gate. Also, in February, an unknown person called Code Enforcement to report this unpermitted work. At that time, Dan Lichau dug approximately 6 foot deep by 2 foot holes and filled them with his iron posts and cement to support his new 7-8 foot iron gate. I believe his new gate extends onto the easement to include his buried posts, and this is why he accessed our water lines and possibly more. Prior to this, there were unused gate supports above ground in a different location, closer to the house, which were torn down.

In addition, Dan Lichau excavated and exposed the water lines from the city hook-up on our utility easement using an excavator that he owns. I learned that water was turned off to the three homes at the end of **Redacted** driveway for a period of time while these water lines were excavated/exposed in preparation for the addition over the set-back. A neighbor thought the City of Santa Rosa had shut off her water one day. She called the City and was told that there were no issues. She then went up the **Redacted** driveway to see if any work was being done on Brush Creek Rd. She saw Dan Lichau working, asked him about the water, and he told her that he shut off the water in order to plant a new olive tree. On information and belief, Dan Lichau accessed our city water (pipes) and may have damaged/repared, altered, re-plumbed, or moved the water lines to facilitate his new addition over the set-back. There are other utilities in the utility easement, which includes sewer, PG&E and water.

Dan Lichau had no reason to excavate, access or shut off **Redacted** neighbors' water from the City because he is on a separate water line.

I am concerned about the safety of our City water because he apparently worked on ^{Redacted} water line and accessed ^{Redacted} utilities easement in secret.

Possible Safety Issue / Fire

The new structure now abuts the driveway, as you probably observed. I feel this may now create a safety hazard with respect to fire because it could possibly hinder ^{Redacted} ability to escape onto Brush Creek Road (as we did in 2017 during the Tubbs Fire), or hinder the Fire Department's access to ^{Redacted} homes at the end of the driveway if necessary. **Redacted**

Extensive Excavation Work and More Throughout Property

Lastly, Dan Lichau has done extensive excavation and work throughout the entire property (outdoor electrical, movement of the pool equipment, new plumbing, HVAC, 7 to 8' iron gate, burying of culverts to re-direct water, heritage tree removal and more). This work was all also done without permits.

(See attached photos of Dan Lichau on his excavator on 5/8/20, which I took ^{Redacted} **Redacted** ^{Redacted} Also see attached photo of the redwood/heritage tree that was cut down to make room for his home addition).

Conclusion



As this new construction adversely altered the character and privacy of the driveway, which I own, I would like to oppose any permit, variance request or possible allowance of the City that would enable the unpermitted addition over the set-back to remain ^{Redacted} **Redacted**. I would like it to be restored to the original set-back of the home with new trees planted and the fence replaced to its original location. A house should not be permitted to exist as a fence-line.

If you have any questions or concerns, please contact me any time at **Redacted**

 Personnel License List for LICHAU, DANIEL PATRICK 

Click on the license number to see a more detailed page of information on that person.

Licenses Currently Associated With

 **License #** 1065989
Business Name LIDOLI CORP
City SAN RAFAEL
Association Date 05/22/2020
Status ACTIVE



**California Secretary of State
Electronic Filing**



Corporation - Statement of Information

Entity Name: LIDOLI, CORP. ✓

Entity (File) Number: C4567706
 File Date: 08/02/2020
 Entity Type: Corporation
 Jurisdiction: CALIFORNIA
 Document ID: GH46774

Detailed Filing Information

1. Entity Name: LIDOLI, CORP. ✓

2. Business Addresses:
 - a. Street Address of Principal Office in California:

1900 Brush Creek Rd ✓
 Santa Rosa, California 95404
 United States of America
 - b. Mailing Address:

1900 Brush Creek Rd
 Santa Rosa, California 95404
 United States of America
 - c. Street Address of Principal Executive Office:

1900 Brush Creek Rd ✓
 Santa Rosa, California 95404
 United States of America

3. Officers:
 - a. Chief Executive Officer:

Daniel Patrick Lichau ✓
 1900 Brush Creek Rd
 Santa Rosa, California 95404
 United States of America
 - b. Secretary:

Philip John Downs
 1900 Brush Creek Rd
 Santa Rosa, California 95404
 United States of America

Document ID: GH46774



California Secretary of State Electronic Filing

Officers (cont'd):

c. Chief Financial Officer:

Mikkel Labourdette Libarle
1900 Brush Creek Rd
Santa Rosa, California 95404
United States of America

4. Director:

Daniel Patrick Lichau
1900 Brush Creek Rd
Santa Rosa, California 95404
United States of America

Number of Vacancies on the Board of
Directors:

0

5. Agent for Service of Process:

Philip John Downs Jr.
57 Elm Ave.
San Anselmo, California 94960
United States of America

6. Type of Business:

General Contractor

By signing this document, I certify that the information is true and correct and that I am authorized by California law to sign.

Electronic Signature: Philip John Downs, Jr.

Use bizfile.sos.ca.gov for online filings, searches, business records, and resources.

Document ID: GH46774



California Secretary of State Electronic Filing

Corporation - Attachment to Statement of Information

List of Additional Directors:

1. Philip John Downs
1900 Brush Creek Rd
Santa Rosa, California 95404
United States of America
2. Mikkel Labourdette Libarle
1900 Brush Creek Rd
Santa Rosa, California 95404
United States of America
- 3.
- 4.
- 5.
- 6.
- 7.

Document ID: GH46774

4567706



Secretary of State
Articles of Incorporation with Statement of Conversion –
California Limited Liability Company to a California Stock Corporation

CONV LLC-GS

FILED HXV
Secretary of State
State of California
FEB 18 2020

IMPORTANT — Read Instructions before completing this form.

Filing Fee - \$150.00

Copy Fees - First page \$1.00; each attachment page \$0.50;
Certification Fee - \$5.00

Note: Most corporations have to pay a minimum \$800 tax to the California Franchise Tax Board each year. For more information, go to <https://www.ftb.ca.gov>.

IPC
This Space For Office Use Only

1. Name of Converted California Corporation (Go to www.sos.ca.gov/business/be/name-availability for general corporate name requirements and restrictions.)

The name of the converted California corporation is LIDOLI, Corp.

2. Business Addresses of the Converted California Corporation (Enter the complete business addresses.)

a. Initial Street Address of Corporation - Do not list a P.O. Box. <u>219 Miranda Ave</u>	City (no abbreviations) <u>San Rafael</u>	State <u>CA</u>	Zip Code <u>94903</u>
b. Initial Mailing Address of Corporation, if different than Item 2a.	City (no abbreviations)	State	Zip Code

3. Service of Process (Must provide either Individual OR Corporation.)

INDIVIDUAL – Complete Items 3a and 3b only. Must include agent's full name and California street address.

a. California Agent's First Name (if agent is not a corporation). <u>Philip</u>	Middle Name <u>J</u>	Last Name <u>Downs</u>	Suffix <u>Jr.</u>
b. Street Address (if agent is not a corporation) - Do not enter a P.O. Box. <u>219 Miranda Ave.</u>	City (no abbreviations) <u>San Rafael</u>	State <u>CA</u>	Zip Code <u>94903</u>

CORPORATION – Complete Item 3c. Only include the name of the registered agent Corporation.

c. California Registered Corporate Agent's Name (if agent is a corporation) – Do not complete Item 3a or 3b.

4. Shares (Enter the number of shares the corporation is authorized to issue. Do not leave blank or enter zero (0).)

This corporation is authorized to issue only one class of shares of stock.
 The total number of shares which this corporation is authorized to issue is 10 million.

- CONTINUE ON NEXT PAGE -
 (Page 1 of 2)

Articles of Incorporation with Statement of Conversion
California Limited Liability Company to a California Stock Corporation
(Page 2 of 2)

4567706

5. Purpose Statement (Do not alter the Purpose Statement.)

The purpose of the corporation is to engage in any lawful act or activity for which a corporation may be organized under the General Corporation Law of California other than the banking business, the trust company business or the practice of a profession permitted to be incorporated by the California Corporations Code.

6. Statement of Conversion for the California Limited Liability Company

6a. The name of the converting California limited liability company is DXP Industries, LLC

6b. The limited liability company's California Secretary of State file number is 201912810259

6c. The principal terms of the plan of conversion were approved by a vote of the members, which equaled or exceeded the vote required under California Corporations Code section 17710.03. There is one class of members entitled to vote and the percentage vote required is a majority in interest of the members. The limited liability company is converting into a California stock corporation.

7. Read, Declare and Sign Below. Do not use computer generated signature. (See instructions for signature requirements.)

Additional article provisions set forth on attached pages, if any, are incorporated herein by reference and made part of this Form CONV LLC-GS. (All attachments should be 8 1/2 x 11, one-sided, legible and clearly marked as an attachment to this Form CONV LLC-GS.)

I declare that I am the person who signed this instrument, which is my act and deed.

 Philippe John Downs, Jr. Member or Manager of
Signature of Member or Manager Type or Print Name
DXP Industries, LLC and Incorporator.
Enter Name of converting California LLC

 Daniel Patrick Lichau Member or Manager of
Signature of Member or Manager Type or Print Name
DXP Industries, LLC and Incorporator.
Enter Name of converting California LLC

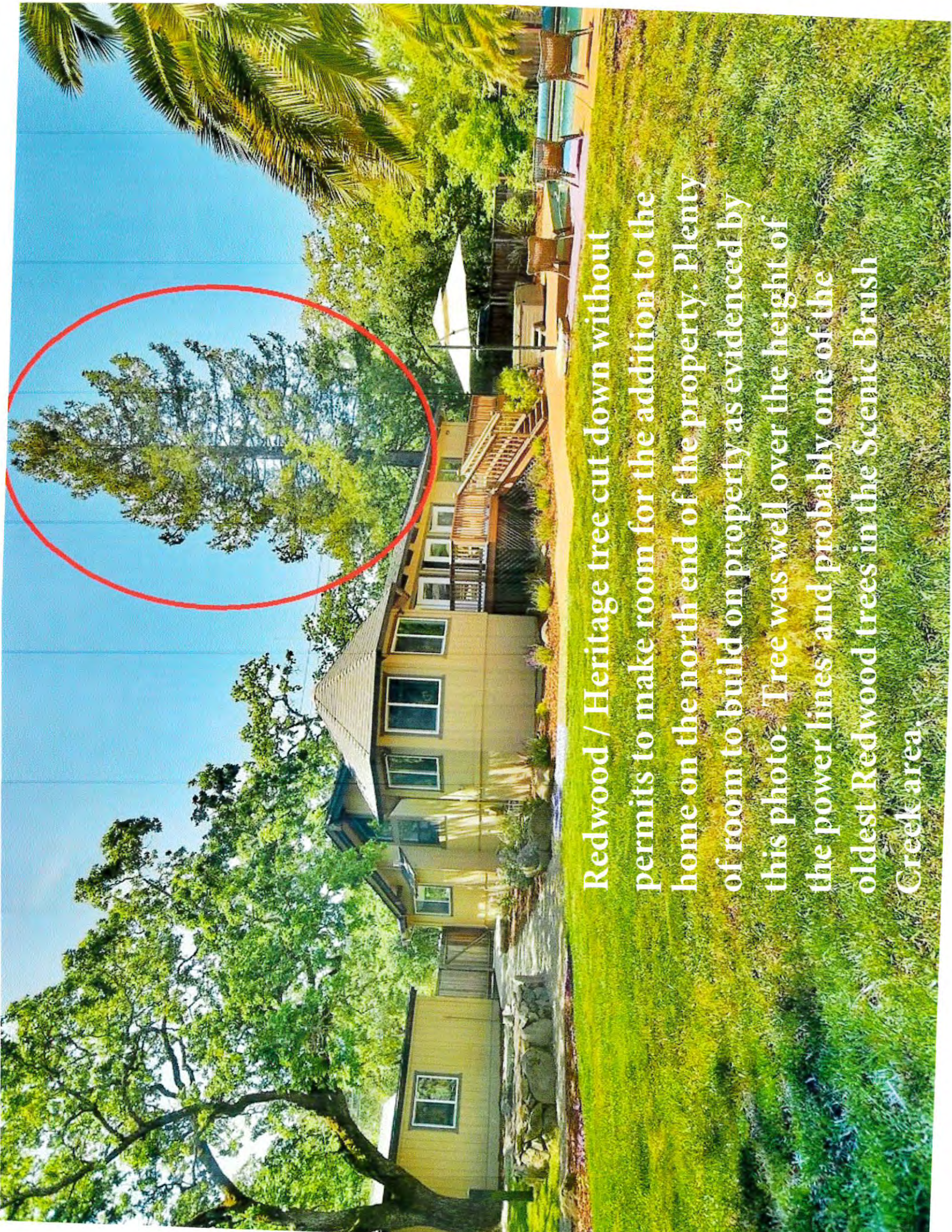

Redwood / Heritage tree cut down without permits to make room for the addition to the home on the north end of the property. Plenty of room to build on property as evidenced by this photo. Tree was well over the height of the power lines and probably one of the oldest Redwood trees in the Scenic Brush Creek area.



Dan Lichau on his excavator on 5/8/20. I took this photo, as Dan Lichau was excavating in the corner of his property **Redacted**

Redacted He had previously indicated that he wanted to replace this fence with a new one that would match his plans for a new fence on the front and side of his house.



Dan Lichau on his excavator on 5/8/20 while digging trenches for culverts placed underground to re-direct water. **Redacted**

Redacted (within a short time of Dan Lichau indicating that he had wanted to take down **Redacted** fence to replace it with a new one that would match his plans for a new fence in the front and side of his property).

Date: 8/25/2020

To: Jesse Oswald, Chief Building Official, City of Santa Rosa [REDACTED] Department of
From: [REDACTED] Redacted *Planning + Economic
Development*
Re: 1900 Brush Creek Rd. – Illegal heritage tree removal, illegal build, unpermitted
work, set-back violations, etc.

COMPLAINTS

On August 3 and August 13, 2020, I filed written complaints with the City of Santa Rosa regarding an unpermitted addition at 1900 Brush Creek Road on a poured, concrete foundation, which extended the home through the property set-back by approximately 9 feet by 30 feet (**SEE ATTACHED SURVEYOR REPORT**). The addition now abuts [REDACTED] [REDACTED] private driveway. (**SEE ATTACHED PHOTO**).

I made complaints in person and by email about this build, although work was allowed to continue after the owner was contacted by the City of Santa Rosa, as the project was determined to be "complete" at that time (**SEE ATTACHED EMAIL**). **Moreover, another citizen had filed a complaint about unpermitted work on this property in February 2020, yet nothing was done, and the work continued.**

During the time since filing my complaints, on information and belief, the owner painted the interior, completed electrical, and strength tested the foundation. It would appear that the owners continued to work on the addition and foundation to make it compliant to code.

HERITAGE TREE

The owner of the property, Daniel Lichau, a licensed contractor, deputy sheriff and construction business owner, cut down an estimated 100-foot redwood tree that was in the property set-back on the shared driveway in order to extend his home without permits or a variance.

This was a healthy, living redwood tree on Scenic Brush Creek, as evidenced in the attached photo. (**SEE ATTACHED**). **Further, I have evidence that the tree was not diseased or a hazard, as I had personally paid Davey Tree, on behalf of my former neighbor at 1900 Brush Creek Road (and later reimbursed), to inspect the trees on his property in March 2019 (Invoice #913420300, March 25, 2019), and the prior property owner could testify to this condition, if needed.**

On information and belief, the unlawful removal of this redwood tree is a violation of Santa Rosa City Code, is a misdemeanor crime and any persons who violate this code *"...shall be denied for a period of two years...approvals or permits...conditional use permits, variances and building or demolition permits."* Santa Rosa City Code, Sections 17-24.100, 17-24.140 and 20-28.050.

FIRE AND SAFETY CONCERN

As outlined in my complaint to the City, the house now abuts my shared driveway, which is the only ingress and egress to three flag lot homes.

This presents a fire hazard, as the home addition is fuel for fire in a shared, private driveway that is also the **only** escape for the residents of three homes on the flag lots. **This addition to the house at 1900 Brush Creek Road reduced the defensible space in the [Redacted] driveway, and therefore also reduced the safety to the citizens on the driveway by increasing fire risk [Redacted] ability to escape during a fire, or for rescuers and first responders to access [Redacted]**

Dan Lichau built his home into the [Redacted] driveway without regard for any code, let alone Fire Code, or other safety requirements. Further, the addition reduces safety in the driveway by obstructing/reducing visibility upon exiting the shared driveway from our homes and more.

FENCE/SHARED DRIVEWAY

A portion of the fence was removed along [Redacted] driveway, and now the home addition not only abuts the [Redacted] driveway, but the house now also serves as the fence. **This addition took the place of [Redacted]. If a fence cannot exceed 6 feet, then how can a house effectively replace a fence on a [Redacted] driveway? This is not characteristic of any other build in this area, and would not be acceptable anywhere else in our area.**

PREFERENTIAL TREATMENT

I am deeply concerned that Dan Lichau, a Deputy Sheriff, is being given preferential treatment in this matter. A regular citizen would not be allowed to cut down a 100 foot heritage tree on a scenic road and then build without care for any code or law. As a licensed contractor and construction company owner, Dan Lichau repeatedly violated numerous requirements for permits and more. I believe this was not an accident, but a deliberate build by a licensed contractor for his own benefit.

No one from the City of Santa Rosa has responded to my Complaints, other than one email that is attached. However, Dan Lichau was allowed to continue to work on the property immediately after Code Enforcement left (see attached email). Also, I learned there were numerous, well-established construction professionals involved with this illegal build. On information and belief, I believe there is a strong possibility that statements and records regarding this construction could have been falsified to validate the build in order to protect the interests of all involved.

REMOVAL OF DIRT FROM BRUSH CREEK ROAD

Lastly, Dan Lichau removed a significant amount of dirt with his excavator from Brush Creek Road. This was dirt and grass belonging to the City of Santa Rosa along Scenic Brush Creek that was previously between his fence line on the street and the sidewalk. **(SEE ATTACHED PHOTOS)**. On information and belief, this unpermitted removal of dirt was used to cover the foundation on his unpermitted extension. This would imply a consciousness of guilt in concealing the foundation.

I would like to please be apprised of the status of my complaints and you can reach me at **Redacted**

Redacted

8/25/2020
Date

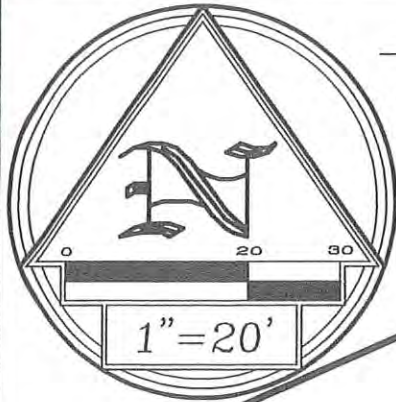

REFERENCES

R1 PARCEL MAP No. 609
635 MAPS 4-7, SONOMA
COUNTY RECORDS

BRUSH CREEK ROAD

S66°28'43"W 100.59' (R1&M)

ROAD, SEWER, AND PUBLIC
UTILITY EASEMENT PER R1

CP 5000
100.00
CONTROL

LOT 2

S20°09'57"E 170.85' (R1&M)

PARCEL MAP NO. 609
635 MAPS 4-7
BUILDING SETBACK LINE

3.45'
8.93'
30.10'
12.13'
ADDITION
11.92'
30.09'
6.87'
8.64'

LOT 3

EXISTING HOUSE

N6°41'30"E 149.77' (R1&M)

BUILDING SETBACK LINE

LEGEND

- FOUND 1/2" IRON PIPE AND TAG "LS 5092 MIKE BUTI"
- R1&M RECORD AND MEASURED DATA ARE IDENTICAL
- △ SURVEY CONTROL POINT
- ⊠ POST
- X— FENCE
- - - TIE LNE
- //— EDGE OF PAVEMENT
- ▨ BUILDING
- BOUNDARY LINE
- BUILDING OVERHANG

SURVEYOR'S STATEMENT

THIS EXHIBIT WAS PREPARED BY ME OR UNDER MY DIRECTION IN CONFORMANCE WITH THE REQUIREMENTS OF THE PROFESSIONAL LAND SURVEYOR'S ACT ON AUGUST 12, 2020.

Ray C. Carlson

RAY C. CARLSON
LS 3890



EXHIBIT PLAT

1900 BRUSH CREEK RD., SANTA ROSA

RAY CARLSON
AND ASSOCIATES, INC.

Mapping for a Better World™

SURVEYING • MAPPING • GIS • CONSULTING
411 RUSSELL AVENUE SANTA ROSA, CALIFORNIA 95403
(707) 528-7649 • RCMAPS.COM

© 2020, Ray Carlson and Associates, Inc.



August 13, 2020 SHEET NO. 1 OF 1 JOB NO. 2020-067

Before and After: 1900 Brush Creek Road, along the shared driveway (~April vs. July 2020)



Before photo (above) and after photo (to left) of the unpermitted addition at 1900 Brush Creek Road that now abuts **Redacted** driveway.

Extension with eaves is approximately 10 feet over the property set-back and within 3 feet of the private road (public utilities easement).



RE: [EXTERNAL] Re: 1900 Brush Creek Road

From: Maystrovich, Mark (mmaystrovich@srcity.org)

To: **Redacted**

Date: Thursday, August 6, 2020, 01:33 PM PDT

Good Afternoon

Thank you for your updates

I was at the property this morning and spoke with the owners. This project is complete and they are now painting the interior. I have also made contact with several other persons involved on this property. They all have been directed to obtain all necessary approvals, permits and inspections for tis project

Mark

Mark Maystrovich |Senior Code Enforcement Officer

Planning and Economic Development |100 Santa Rosa Avenue | Santa Rosa, CA 95404

Tel. (707) 543-3268 | Fax (707) 543-4315 | mmaystrovich@srcity.org

Hello and thank you for your email. Please note: The City of Santa Rosa has closed most of its public counters until further notice to help curb a resurgence of coronavirus infections occurring in Sonoma County and statewide. Access to most City services remains available online, by phone, and in some instances in-person by appointment. For a current list of those services, visit srcity.org/ServiceFinder.

For detailed information about the City of Santa Rosa's ongoing response the coronavirus public health emergency, please visit the City's website at srcity.org/PreventTheSpread

From: [Redacted]
Sent: Thursday, August 6, 2020 10:37 AM
To: Maystrovich, Mark <MMaystrovich@srcity.org>
Subject: [EXTERNAL] Re: 1900 Brush Creek Road

Hi Mark,

Work continues on this project today (1900 Brush Creek Road). Just a heads up.

Kind regards,

[Redacted]

On Wednesday, August 5, 2020, 11:10:45 AM PDT, [Redacted] wrote:

Hi Mark,

It appears that work is in progress at the property now. I just wanted to make you aware.

Thank you,

[Redacted]

On Wednesday, August 5, 2020, 9:21:10 AM PDT, [Redacted] wrote:

Hi Mark,

I dropped off a complaint yesterday at the City regarding 1900 Brush Creek Road and understand that you have been assigned to this matter. I live at 1888 Brush Creek Road, which is next door.

I wanted to confirm that you received my complaint, **and** also wanted to let you know that my spouse notified the neighbor at 1900 Brush Creek this morning that I filed a complaint with the City (as he felt it was the right thing to do to so the neighbor wouldn't be surprised). The neighbor was previously not aware, so I wanted to let you know this, in case you have not yet been by the property.

Please let me know what your next steps are and feel free to reach me anytime on my cell

Redacted

Kind regards,

Redacted



Redwood / Heritage tree cut down without permits to make room for the addition to the home on the north end of the property. Plenty of room to build on property as evidenced by this photo. Tree was well over the height of the power lines and probably one of the oldest Redwood trees in the Scenic Brush Creek area.

Before Photo showing Dirt Between Fence and Sidewalk on Scenic Brush Creek Road



After Unpermitted Excavation of Dirt along Scenic Brush Creek Road



Maystrovich, Mark

From: Oswald, Jesse
Sent: Tuesday, September 1, 2020 7:17 AM
To: Maystrovich, Mark; Schalich, Cindy
Subject: FW: [EXTERNAL] Deputy Sheriff/Contractor - Illegal Build

FYI

Jesse Oswald | Chief Building Official

Planning & Economic Development | 100 Santa Rosa Avenue, Room 3 | Santa Rosa, CA 95404
Tel. (707) 543-3249 | Fax (707) 543-3219 | joswald@srcity.org



From: Oswald, Jesse
Sent: Tuesday, September 01, 2020 7:08 AM
To: [REDACTED]
Cc: Mahre, Kali <KMahre@srcity.org>
Subject: RE: [EXTERNAL] Deputy Sheriff/Contractor - Illegal Build

Good morning [REDACTED]

My apologies for delays in response and the difficulties you have endured. Thank you for the detailed information on the matter next door. The details will definitely assist with the investigation.

Since beginning the investigation on the matter, our Code Enforcement and Planning Divisions have worked with the owner of 1900 Brush Creek Rd. to determine a path to legalize the addition. In no instance will any aspect of the project be "rubber-stamped". Any and all projects are required to meet all regulations administered by this department. If any variances are required, appropriate applications for them will be required and that-being an entitlement – will require public notification.

The process is still in infancy with plan development and evaluation by the professionals charged with ensuring compliance with all applicable zoning codes, building codes, and applicable regulations.

The matter of a tree removal without approvals has been referred to our City Attorney's Office for input.

Please feel free to call me with any additional details or concerns.

Regards,

Jesse

Jesse Oswald | Chief Building Official

Planning & Economic Development | 100 Santa Rosa Avenue, Room 3 | Santa Rosa, CA 95404
Tel. (707) 543-3249 | Fax (707) 543-3219 | joswald@srcity.org



From: [REDACTED] **Redacted**

Sent: Monday, August 31, 2020 8:09 AM

To: Schwedhelm, Tom <tschwedhelm@srcity.org>; Fleming, Victoria <VFleming@srcity.org>; Olivares, Ernesto <EOlivares@srcity.org>; Rogers, Chris <CRogers@srcity.org>; Sawyer, John <jsawyer@srcity.org>; Tibbetts, Jack <hjtibbetts@srcity.org>; Dowd, Richard <RDowd@srcity.org>; Oswald, Jesse <JOswald@srcity.org>; CMOOffice <CMOffice@srcity.org>

Subject: [EXTERNAL] Deputy Sheriff/Contractor - Illegal Build

To: Santa Rosa City Council Members, Chief Building Official, City Manager, and City Attorney (via hard copy),

The City of Santa Rosa appears to be giving a Deputy Sheriff/licensed contractor preferential treatment with his illegal, unpermitted home addition on scenic Brush Creek Road, in which multiple permit requirements and zoning codes were deliberately ignored, a 100-foot redwood tree (heritage tree) was dropped without any permit on a scenic road (misdemeanor crime), and construction was completed during the shelter-in-place orders.

Not a single permit was sought by the Deputy Sherriff/contractor in advance of this illegal build, nor was a variance obtained for building **9 feet by 30 feet over his property set-back** (a zoning code violation), nor was a permit obtained for **cutting down a 100-foot redwood tree (heritage tree) in the property set-back on the protected scenic Brush Creek Road**. In my opinion, this was a greedy land-grab during the pandemic to expand the square footage of a home by adding a luxury master bathroom, a master walk-in closet and an additional bedroom...all on a poured, concrete foundation with no permits.

This willful and deliberate conduct to disobey Santa Rosa building codes, property set-backs, heritage tree removal codes (and more) by a Deputy Sheriff, who is also a licensed contractor *and* a construction company business owner, would indicate that he feels above the law, and, **"if it stays, it pays."**

While countless fire victims and contractors in Santa Rosa obeyed the laws to obtain permits, seek variances, follow rules regarding heritage trees, and stopped work during the shelter in place orders from Governor Newsom and Sonoma County Public Health Officer, Dr. Mase, it would appear that the Deputy Sheriff/contractor on Brush Creek Road felt the laws did not apply to him. If this illegal build is enabled by the City to remain without any repercussion, it would seem there is unequal application of the laws and codes for this homeowner.

I am a quiet finance professional who has never made a complaint to the City of Santa Rosa (or any city, for that matter) in my life. Yet, both myself **and another unknown complainant, who complained 6 months before me**, have largely been ignored. Nothing was done by the City with regard to a February 19, 2020 complaint about unpermitted work being done, and work on the property continued.

On August 4, I submitted a complaint about the illegal build with the City, and was told that the Senior Code Enforcement Officer, who had been assigned to this matter in mid-February, was Mark Maystrovich. I then left a voicemail for Mark and emailed several times over two days, as work was continuing on the property. On August 6, I received an email from Mark that he had spoken with the

owners and “several other persons involved” and the “project is complete,” and they were “now painting.” Mr. Maystrovich drove out and saw the home addition, drove past my house next door (u-turn on a dead-end shared driveway) and left without ever speaking with me.

After filing two more documents with the City regarding other unpermitted work that was done on the property, along with submitting a surveyor’s report showing the 9 foot by 30 foot violation over the property set-back, I learned in conversation while filing my documents that the homeowner has now submitted plans to City Planning, which might include calling the new addition an Auxiliary Dwelling Unit (ADU or junior ADU). If the plans now show this addition as an ADU/junior ADU, it would be a lie and a fraud on the City.

If now, after getting reported to Code Enforcement, plans are created and submitted showing the structure was built as an ADU, it would be a conspiracy by the owners and all parties who worked on this property to get this project rubber-stamped by the City by any means possible (fraud), to push through this illegal build over a property set-back without necessitating a variance or public hearing. **This addition was not intended as an ADU and will not be used as such.**

The Senior Code Enforcement Officer went to the property on August 6 (again, initial complaint was filed February 19). He would have observed this was not a junior ADU, as there is no separate efficiency kitchen. Moreover, City Code requires a junior ADU to be constructed within the existing walls of house. This addition is comprised of new walls, new framing, a new foundation, new roof, etc. that is built out from the existing structure by 12 feet by 30 feet, with 9 feet by 30 feet over the property set-back. It is not within the existing structure. Code Enforcement would have observed this extension of the master bedroom of the house, which was expanded to include a large walk-in closet, a remodeled high-end, en suite master bathroom, and an additional bedroom for one of the three children. If this is now being enabled to be called a junior ADU, or re-constructed to be a junior ADU, this is a cover-up and a fraud to enable the structure to be permitted over the property set-back, without a variance or public hearing.

The homeowner has a ½ acre lot with ample room to build elsewhere. But he chose instead to cut down a 100-foot, healthy heritage tree (probably one of the oldest on Brush Creek Rd.) and build over his property set-back for his master bedroom and master bathroom extension. **And, very simply...he got caught. It got reported.** Now, it seems the City is helping him to get necessary approvals without any need for a variance, with full knowledge that it is not an ADU. When is enough, enough? When do egregious violations get punished, and if not, what deterrent is there? Many neighbors were told by the homeowners during the build that it was an addition to their master bedroom/bathroom and a bedroom for one of his three children. If the City is being told that this build was for an ADU, this is a lie. There is already a separate structure/guest house on the property that would be the logical location for an ADU.

The City Council adopted regulations to protect heritage trees and to regulate arbitrary tree removal. City Code 17-24 provides for the Code on tree removal and discusses that it is a **misdemeanor crime** to cut down such trees without a permit. (Ord. 3238 § 28 (d), 1996; Ord. 2858 § 1, 1990, Ord. 3699 § 3, 2005). **Further, Section 17-24.140 states that homeowners who commit such tree violations of section 17-24 shall be denied city approvals or permits, for a period of two years from date of the City’s discovery of the violation, which might have otherwise been issued by the City for the development or further improvement of the property.** “Prohibited approvals or permits shall include, but not limited to, conditional use permits, variances, and building or demolition permits. The provisions of this section shall not apply to any approval or permit which is needed or required to maintain the health or safety of those occupying existing improvements on the property.” (Ord. 2858 § 1, 1990)

I had made the City aware that the 100-foot heritage tree had been cut down by the homeowner on August 4, 2020, and Code Enforcement went to the property two days later and saw this first-hand. Neighbors witnessed the homeowner directing the tree to be cut down. **Therefore**, pursuant to Section 17-24.140, **no permits should be given for the development or further build on this property for a period of 2 years. Furthermore, provisions of 17-24.140 would apply to the illegal extension/junior ADU, as (1) the addition is not occupied, and even as a junior ADU, it legally should not be occupied by the homeowners, as they would presumably occupy the primary residence instead, (2) permitting the structure for use as an ADU is neither a matter of "health" nor "safety" and (3) the addition is not an "existing" improvement. It is not part of the existing structure, which is evidenced on county parcel and surveyor maps.**

The redwood tree that was in the area between the property set-back and the fence line, was healthy and not a hazard, as evidenced by photos I provided to the City. **In fact, I had personally paid Davey Tree in March 2019** to inspect the former property owner's trees at this address (and then reimbursed by my former neighbor), as I had Davey Tree at my property and my former neighbor asked if they could also examine and trim his trees. The former property owner could attest to this. It was a healthy redwood that was probably at least 80 years old. ([Photo](#) of the redwood tree on Zillow approximately 1 year ago).

The illegal addition has replaced the fence line and now abuts **Redacted** driveway and a utilities easement. (If a fence cannot exceed 6 feet, how can a house replace a fence?). For the City to rubber-stamp or somehow permit any plans submitted now, after the fact, as an ADU would be fraud on the City of Santa Rosa and would clearly demonstrate the City's preferential treatment for the party involved and an unequal application of the laws.

Moreover, the lack of transparency and candor in this matter by the City and the Deputy Sheriff/contractor is troubling. No information was provided to me on the disposition of the February 19 complaint. Only when I asked directly about this complaint (which was not even on the public website until August 5 or thereabouts), there was no valid explanation. The COVID shut down did not occur until March. It would appear a free pass/green light must have been given to the Deputy Sheriff/contractor with the first complaint. Further, no City official has proactively contacted me, the complainant, to discuss this matter. The City seems to be enabling and protecting the offending party in this matter and not protecting the property rights of other homeowners or enforcing the laws that were created with regard to scenic roads, heritage trees, zoning codes and the like.

I invite each of you to take a 5-8 minute drive from your offices downtown to 1900 Brush Creek Rd (between Hwy 12 and Montecito Blvd.) to see the violation first-hand. Had a 5-8 minute drive to the home been done in February, it would likely have stopped the illegal build from happening. I believe you will see this blatant land grab during a pandemic for what it is, a shocking case of greed for personal/financial gain. And I would ask you to look into this matter immediately, as the City of Santa Rosa seems to be enabling the illegal addition to the home to remain intact, regardless of the conduct, laws broken, fraud, increased fire risk (i.e. reduced defensible space and more) in the driveway, etc. If this structure is allowed, I feel the message that City Council and City Officials will send to the public is that a Deputy Sheriff/contractor is not held to the same building, zoning and tree removal codes and laws as other citizens, and **"if it stays, it pays."**

Neighbors trusted that a Deputy Sheriff (who parks his marked patrol car in the driveway every day) would have obtained necessary permits and obeyed the City's building and zoning laws. During the build, several well-established construction professionals were also involved during the shelter-in-place orders and would protect the homeowner for their own self-interests. I believe the City will quickly work with the homeowner to push this through, as it does not want its own lack of action since

mid-February made public. Now a heritage tree is gone, a house has been built through a set-back onto a **Redacted** driveway, and the natural characteristics of the scenic road have been destroyed.

Again, please drive the 5-8 minutes from your office and see for yourself. As you review the attached documents and photos, I believe you will see this for what it is: an unlawful land-grab and a willful and knowing violation of many permit requirements and zoning codes during the pandemic by a Deputy Sheriff/contractor, **who knows better**.

It is the **totality** of this construction that is at issue. All was unpermitted. A heritage tree was cut down when it should have been protected in a set-back, the addition violates a property set-back and more. No one should be above the law and no one, especially the City of Santa Rosa, should be protecting this egregious conduct.

Sincerely,

Redacted

Maystrovich, Mark

From: Oswald, Jesse
Sent: Wednesday, September 9, 2020 1:31 PM
To: Anderson, Cassidy
Cc: Maystrovich, Mark
Subject: FW: [EXTERNAL] Deputy Sheriff/Contractor - Illegal Build 1900 Brush Creek

Info for the case

Jesse Oswald | Chief Building Official

Planning & Economic Development | 100 Santa Rosa Avenue, Room 3 | Santa Rosa, CA 95404
Tel. (707) 543-3249 | Fax (707) 543-3219 | joswald@srcity.org



From: [Redacted]
Sent: Wednesday, September 02, 2020 4:19 PM
To: Oswald, Jesse <JOswald@srcity.org>
Cc: Mahre, Kali <KMahre@srcity.org>; CMOOffice <CMOffice@srcity.org>
Subject: Re: [EXTERNAL] Deputy Sheriff/Contractor - Illegal Build

Jesse,

The windows to the master bathroom and walk-in closet area of the new/illegal build are covered with cardboard (as of today), and hammering could be heard. The windows to the new extra bedroom are not covered and haven't changed.

Per your email, your position is that the City is working with the owner "to determine a path to legalize the (illegal) addition." And it appears that work continues on this illegal build to this day.

Is this illegal build red-tagged?

Thank you,

[Redacted]

On Tuesday, September 1, 2020, 07:07:53 AM PDT, Oswald, Jesse <joswald@srcity.org> wrote:

Good morning [Redacted]

My apologies for delays in response and the difficulties you have endured. Thank you for the detailed information on the matter [Redacted]. The details will definitely assist with the investigation.

Since beginning the investigation on the matter, our Code Enforcement and Planning Divisions have worked with the owner of 1900 Brush Creek Rd. to determine a path to legalize the addition. In no instance will any aspect of the project be "rubber-stamped". Any and all projects are required to meet all regulations administered by this department. If any variances are required, appropriate applications for them will be required and that-being an entitlement – will require public notification.

The process is still in infancy with plan development and evaluation by the professionals charged with ensuring compliance with all applicable zoning codes, building codes, and applicable regulations.

The matter of a tree removal without approvals has been referred to our City Attorney's Office for input.

Please feel free to call me with any additional details or concerns.

Regards,

Jesse

Jesse Oswald | Chief Building Official

Planning & Economic Development | 100 Santa Rosa Avenue, Room 3 | Santa Rosa, CA 95404

Tel. (707) 543-3249 | Fax (707) 543-3219 | joswald@srcity.org



From: [REDACTED] **Redacted**
Sent: Monday, August 31, 2020 8:09 AM
To: Schwedhelm, Tom <tschwedhelm@srcity.org>; Fleming, Victoria <VFleming@srcity.org>; Olivares, Ernesto <EOlivares@srcity.org>; Rogers, Chris <CRogers@srcity.org>; Sawyer, John <jsawyer@srcity.org>; Tibbetts, Jack <hitibbetts@srcity.org>; Dowd, Richard <RDowd@srcity.org>; Oswald, Jesse <JOswald@srcity.org>; CMOOffice <CMOOffice@srcity.org>
Subject: [EXTERNAL] Deputy Sheriff/Contractor - Illegal Build

To: Santa Rosa City Council Members, Chief Building Official, City Manager, and City Attorney (via hard copy),

The City of Santa Rosa appears to be giving a Deputy Sheriff/licensed contractor preferential treatment with his illegal, unpermitted home addition on scenic Brush Creek Road, in which multiple permit requirements and zoning codes were deliberately ignored, a 100-foot redwood tree (heritage tree) was dropped without any permit on a scenic road (misdemeanor crime), and construction was completed during the shelter-in-place orders.

Not a single permit was sought by the Deputy Sherriff/contractor in advance of this illegal build, nor was a variance obtained for building **9 feet by 30 feet over his property set-back** (a zoning code violation), nor was a permit obtained for **cutting down a 100-foot redwood tree (heritage tree) in the property set-back on the protected scenic Brush Creek Road**. In my opinion, this was a greedy land-grab during the pandemic to expand the square footage of a home by adding a luxury master bathroom, a master walk-in closet and an additional bedroom...all on a poured, concrete foundation with no permits.

This willful and deliberate conduct to disobey Santa Rosa building codes, property set-backs, heritage tree removal codes (and more) by a Deputy Sheriff, who is also a licensed contractor *and* a construction company business owner, would indicate that he feels above the law, and, **“if it stays, it pays.”**

While countless fire victims and contractors in Santa Rosa obeyed the laws to obtain permits, seek variances, follow rules regarding heritage trees, and stopped work during the shelter in place orders from Governor Newsom and Sonoma County Public Health Officer, Dr. Mase, it would appear that the Deputy Sheriff/contractor on Brush Creek Road felt the laws did not apply to him. If this illegal build is enabled by the City to remain without any repercussion, it would seem there is unequal application of the laws and codes for this homeowner.

I am a quiet finance professional who has never made a complaint to the City of Santa Rosa (or any city, for that matter) in my life. Yet, both myself **and another unknown complainant, who complained 6 months before me**, have largely been ignored. Nothing was done by the City with regard to a February 19, 2020 complaint about unpermitted work being done, and work on the property continued.

On August 4, I submitted a complaint about the illegal build with the City, and was told that the Senior Code Enforcement Officer, who had been assigned to this matter in mid-February, was Mark Maystrovich. I then left a voicemail for Mark and emailed several times over two days, as work was continuing on the property. On August 6, I received an email from Mark that he had spoken with the owners and *“several other persons involved”* and the *“project is complete,”* and they were *“now painting.”* Mr. Maystrovich drove out and saw the home addition, drove past my house next door (u-turn on a dead-end shared driveway) and left without ever speaking with me.

After filing two more documents with the City regarding other unpermitted work that was done on the property, along with submitting a surveyor's report showing the 9 foot by 30 foot violation over the property set-back, I learned in conversation while filing my documents that the homeowner has now submitted plans to City Planning, which might include calling the new addition an Auxiliary Dwelling Unit (ADU or junior ADU). If the plans now show this addition as an ADU/junior ADU, it would be a lie and a fraud on the City.

If now, after getting reported to Code Enforcement, plans are created and submitted showing the structure was built as an ADU, it would be a conspiracy by the owners and all parties who worked on this property to get this project rubber-stamped by the City by any means possible (fraud), to push through this illegal build over a property set-back without necessitating a variance or public hearing. **This addition was not intended as an ADU and will not be used as such.**

The Senior Code Enforcement Officer went to the property on August 6 (again, initial complaint was filed February 19). He would have observed this was not a junior ADU, as there is no separate efficiency kitchen. Moreover, City Code requires a junior ADU to be constructed within the existing walls of house. This addition is comprised of new walls, new framing, a new foundation, new roof, etc. that is built out from the existing structure by 12 feet by 30 feet, with 9 feet by 30 feet over the property set-back. It is not within the existing structure. Code Enforcement would have observed this extension of the master bedroom of the house, which was expanded to include a large walk-in closet, a remodeled high-end, en suite master bathroom, and an additional bedroom for one of the three children. If this is now being enabled to be called a junior ADU, or re-constructed to be a junior ADU, this is a cover-up and a fraud to enable the structure to be permitted over the property set-back, without a variance or public hearing.

The homeowner has a ½ acre lot with ample room to build elsewhere. But he chose instead to cut down a 100-foot, healthy heritage tree (probably one of the oldest on Brush Creek Rd.) and build over his property set-back for his master bedroom and master bathroom extension. **And, very simply...he got caught. It got reported.** Now, it seems the City is helping him to get necessary approvals without any need for a variance, with full knowledge that it is not an ADU. When is enough, enough? When do egregious violations get punished, and if not, what deterrent is there? Many neighbors were told by the homeowners during the build that it was an addition to their master bedroom/bathroom and a bedroom for one of his three children. If the City is being told that this build was for an ADU, this is a lie. There is already a separate structure/guest house on the property that would be the logical location for an ADU.

The City Council adopted regulations to protect heritage trees and to regulate arbitrary tree removal. City Code 17-24 provides for the Code on tree removal and discusses that it is a **misdemeanor crime** to cut down such trees without a permit. (Ord. 3238 § 28 (d), 1996; Ord. 2858 § 1, 1990, Ord. 3699 § 3, 2005). **Further, Section 17-24.140 states that homeowners who commit such tree violations of section 17-24 shall be denied city approvals or permits, for a period of two years from date of the City's discovery of the violation, which might have otherwise been issued by the City for the development or further improvement of the property.** "Prohibited approvals or permits shall include, but not limited to, conditional use permits, variances, and building or demolition permits. The provisions of this section shall not apply to any approval or permit which is needed or required to maintain the health or safety of those occupying existing improvements on the property." (Ord. 2858 § 1, 1990)

I had made the City aware that the 100-foot heritage tree had been cut down by the homeowner on August 4, 2020, and Code Enforcement went to the property two days later and saw this first-hand. Neighbors witnessed the homeowner directing the tree to be cut down. **Therefore**, pursuant to Section 17-24.140, **no permits should be given for the development or further build on this property for a period of 2 years. Furthermore, provisions of 17-24.140 would apply to the illegal extension/junior ADU, as** (1) the addition is not occupied, and even as a junior ADU, it legally should not be occupied by the homeowners, as they would presumably occupy the primary residence instead, (2) permitting the structure for use as an ADU is neither a matter of "health" nor "safety" and (3) the addition is not an "existing" improvement. It is not part of the existing structure, which is evidenced on county parcel and surveyor maps.

The redwood tree that was in the area between the property set-back and the fence line, was healthy and not a hazard, as evidenced by photos I provided to the City. In fact, I had personally paid Davey Tree in March 2019 to inspect the former property owner's trees at this address (and then reimbursed by my former neighbor), as I had Davey Tree [Redacted] former neighbor asked if they could also examine and trim his trees. The former property owner could attest to this. It was a healthy redwood that was probably at least 80 years old. (Photo of the redwood tree on Zillow approximately 1 year ago).

The illegal addition has replaced the fence line and now abuts my shared, private driveway and a utilities easement. (If a fence cannot exceed 6 feet, how can a house replace a fence?). For the City to rubber-stamp or somehow permit any plans submitted now, after the fact, as an ADU would be fraud on the City of Santa Rosa and would clearly demonstrate the City's preferential treatment for the party involved and an unequal application of the laws.

Moreover, the lack of transparency and candor in this matter by the City and the Deputy Sheriff/contractor is troubling. No information was provided to me on the disposition of the February 19 complaint. Only when I asked directly about this complaint (which was not even on the public website until August 5 or thereabouts), there was no valid explanation. The COVID shut down did not occur until March. It would appear a free pass/green light must have been given to the Deputy Sheriff/contractor with the first complaint. Further, no City official has proactively contacted me, the complainant, to discuss this matter. The City seems to be enabling and protecting the offending party in this matter and not protecting the property rights of other homeowners or enforcing the laws that were created with regard to scenic roads, heritage trees, zoning codes and the like.

I invite each of you to take a 5-8 minute drive from your offices downtown to 1900 Brush Creek Rd (between Hwy 12 and Montecito Blvd.) to see the violation first-hand. Had a 5-8 minute drive to the home been done in February, it would likely have stopped the illegal build from happening. I believe you will see this blatant land grab during a pandemic for what it is, a shocking case of greed for personal/financial gain. And I would ask you to look into this matter immediately, as the City of Santa Rosa seems to be enabling the illegal addition to the home to remain intact, regardless of the conduct, laws broken, fraud, increased fire risk (i.e. reduced defensible space and more) in the driveway, etc. If this structure is allowed, I feel the message that City Council and City Officials will send to the public is that a Deputy Sheriff/contractor is not held to the same building, zoning and tree removal codes and laws as other citizens, and **"if it stays, it pays."**

Neighbors trusted that a Deputy Sheriff (who parks his marked patrol car in the driveway every day) would have obtained necessary permits and obeyed the City's building and zoning laws. During the build, several well-established construction professionals were also involved during the shelter-in-place orders and would protect the homeowner for their own self-interests. I believe the City will quickly work with the homeowner to push this through, as it does not want its own lack of action since mid-February made public. Now a heritage tree is gone, a house has been built through a set-back onto a shared, private driveway, and the natural characteristics of the scenic road have been destroyed.

Again, please drive the 5-8 minutes from your office and see for yourself. As you review the attached documents and photos, I believe you will see this for what it is: an unlawful land-grab and a willful and knowing violation of many permit requirements and zoning codes during the pandemic by a Deputy Sheriff/contractor, **who knows better.**

It is the **totality** of this construction that is at issue. All was unpermitted. A heritage tree was cut down when it should have been protected in a set-back, the addition violates a property set-back and more.

No one should be above the law and no one, especially the City of Santa Rosa, should be protecting this egregious conduct.

Sincerely,

Redacted

