

McNeill Real Estate Services, Inc.

NORTHPOINT PARKWAY AT THUNDERBOLT WAY
SANTA ROSA, CALIFORNIA

City of Santa Rosa
 Planning & Development Department
 Apr 5, 2023
 RECEIVED

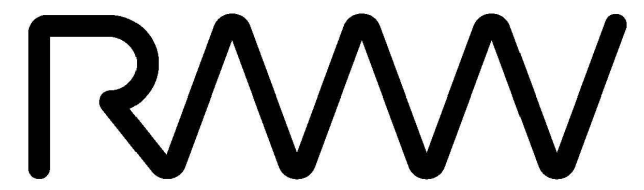

RMW Architecture Interiors 1718 Third Street Suite 101 Sacramento California 95811

Office 916 449-1400

rmw.com

CLIENT:

McNeill Real Estate Services
Joseph A McNeill, III

916 718 5659
Ca DRE # 01138862

PRELIMINARY DESIGN DOCUMENTS FOR:

NORTHPOINT COMMERCE CENTER

NORTHPOINT PARKWAY AT THUNDERBOLT WAY
SANTA ROSA, CALIFORNIA

approved for the owner by :

approved for the architect by :

issue :	description :	date :
A	ISSUED FOR REVIEW	03.21.2023



VIEW OF NORTH EAST CORNER

PROJECT NARRATIVE:

Design Concept: The design concept and design approach for the building is based on and takes its cues from the architectural style of modernism which is characterized by clean geometric forms and clean lines with an emphasis on the horizontal aspect of the building's facade.

Site: The project site is located on the south side of Northpoint Parkway between Kingfisher and Thunderbolt Ways, in the City of Santa Rosa, California. The 6.81 acre site is currently undeveloped.

Building: The project plan proposes one industrial building totaling 114,884 square feet. The industrial buildings will be of Type VB construction, site cast, tilted concrete panels with a variety of architectural enhancements. The typical wall panels are to be enhanced with reveals and a textured elastomeric, multicolored coating system. The areas around the building entries are also enhanced with tinted glazing in aluminum frames with overhead steel-framed painted canopies. The placement of these enhancements is focused at those locations most visible from the public roadways.

Site Access and Parking: One site entrance drive is proposed along Kingfisher Way. A second drive is provided along Thunderbolt Way. The site plan proposes a total of 166 vehicle parking stalls for employees and or customers.

Signage: The proposed signage in this submittal is for reference only. Criteria for future tenant signage will be provided at a later date and under a separate permit as required.

Landscaping: The project will be fully landscaped using plants appropriate for and indigenous to the City of Santa Rosa. Low water use plants will be used extensively, while moderate water use plants will be concentrated at accent points, such as driveways and building entries.

Sustainable Materials & Construction Practices: The project will incorporate a variety of sustainable materials and construction practices to include the following: 1) A storm water pollution prevention plan to minimize contamination, erosion, and dust pollution during construction. All storm water runoff from impervious surfaces (roofs and paving) will be routed through a specially designed water quality detention and treatment basin. Additionally, if needed, on-site detention will be provided to meet the City of Santa Rosa standards. 2) Storage and collection of recyclable materials. 3) Construction waste management. 4) Environmental tobacco smoke control. 5) Heat reflecting roof membranes. 6) Light pollution reduction. 7) Water efficient landscaping. 8) Water use reduction methods. 9) Low VOC emitting sealants, adhesives, coatings, floorings, and wood materials. 10) Roof structures designed to accommodate additional weight for roof-top photovoltaic electricity generation panel arrays. 11) California Green Building Code compliant electric vehicle charging stations at eight locations. 12) The project architect is a LEED accredited professional and will apply his knowledge of LEED techniques and practices to the project design and construction.

VICINITY MAP:



PROJECT TEAM:

OWNER MCNEILL REAL ESTATE SERVICES, INC. 5245 TAPESTRY CT. FAIRFIELD, CA 94534 P: 916-718-5659	JOSEPH A. McNEILL, III mcneill.jose@gmail.com
ARCHITECT: RMW ARCHITECTURE & INTERIORS 1718 3RD STREET, SUITE 101 SACRAMENTO, CA 95811 P: 916-449-1400 x405	JEFF LEONHARDT, PROJECT ARCHITECT & PROJECT DESIGNER jleonhardt@rmw.com
CIVIL ENGINEER: BC ENGINEERING GROUP INC. 4188 B STREET - 3rd FLOOR SANTA ROSA, CA 95401 P: 707-542-4321	TOM BILLETER, P.E. tb@bcengineeringgroup.com
LANDSCAPE DESIGNER DESIREE GARON 308 HATCHERY LANE SONOMA, CA 95476 P: 707-694-6139	DESIREE GARON dgaron@magrane.com

SHEET INDEX:

A00.1	COVER SHEET *
A00.2	PROJECT RENDERINGS *
A01.1	PRELIMINARY SITE PLAN *
A01.2	SITE DETAILS
A02.1	PRELIMINARY FLOOR PLAN
A02.2	PRELIMINARY ROOF PLAN
A03.1	EXTERIOR ELEVATIONS *
A04.1	SIGHT LEVEL SECTIONS
C1.0	PROJECT INFORMATION
C1.1	PRELIMINARY GRADING AND UTILITY PLAN
C1.2	PRELIMINARY CROSS SECTION VIEWS
L1.0	LANDSCAPE SITE PLAN *
PH01.0	PRELIMINARY LIGHTING SITE PLAN
PH01.1	PRELIMINARY PHOTOMETRIC LIGHTING SITE PLAN
PH01.2	LIGHTING CUT SHEETS

* DENOTES A SHEET TO BE PRINTED IN FULL COLOR

drawn by : TLG plot date : 09-03-2021

checked by : AG/JDL

stamp

scale : AS NOTED

project number : 2204025.00

COVER SHEET

sheet no. :

A00.1

CLIENT:

**McNeill Real Estate
Services**
Joseph A McNeill, III

916 718 5659
Ca DRE # 01138862

PRELIMINARY DESIGN DOCUMENTS FOR:

**NORTHPOINT
COMMERCE
CENTER**

NORTHPOINT PARKWAY AT
THUNDERBOLT WAY
SANTA ROSA, CALIFORNIA

approved for the owner by :

approved for the architect by :

issue :	description :	date :
A	ISSUED FOR REVIEW	03/21/2023



C: VIEW OF NORTH EAST CORNER



A: VIEW OF FRONT ELEVATION



B: VIEW OF NORTH WEST CORNER

PROJECT RENDERINGS

SCALE: NO SCALE

1

drawn by : TLG plot date : 09-03-2021

checked by : AGUJDL

stamp

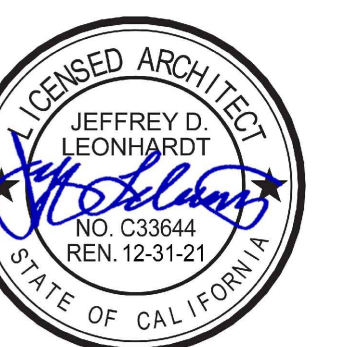

scale : AS NOTED

project number : 2204025.00

**PROJECT
RENDERINGS**

sheet no. :

A00.2

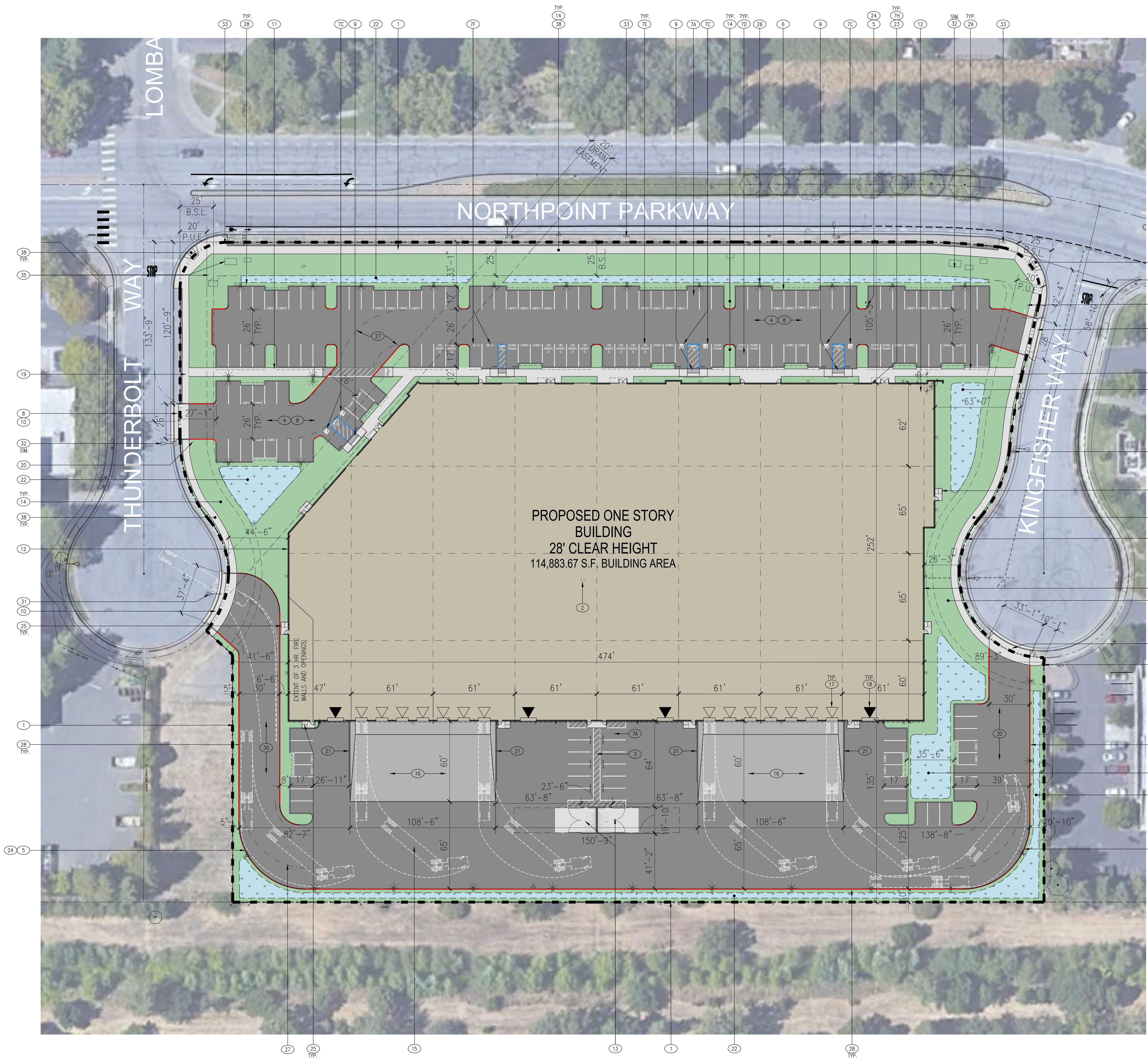

SITE INFORMATION / STATISTICS:

SITE STATISTICS:		035-530-022-000
APN:		
ZONING:		IG - LIGHT INDUSTRIAL
SITE AREA:	296,438 G.S.F. = 6.81 ACRES	
BUILDING AREA:	114,883.67 G.S.F.	
SITE COVERAGE:	38.75 % (GROSS)	
CONSTRUCTION TYPE:		III OR V-B
BUILDING HEIGHT:	37'-4"	
NUMBER OF STORIES:	1	
TOTAL PARKING REQUIRED:		115 (114,884 @ 1/1,000 S.F.)
OFFICE: (5% ASSUMED)		
WAREHOUSE: (95% ASSUMED)		
RIDESHARING STALLS:		16 (REQ. PER 2019 CALGREEN)
(CARPOOL / VANPOOL)		
TOTAL STALLS PROVIDED:		115
TOTAL VEHICLE PARKING PROVIDED:		93
STANDARD STALLS: 9'X19' (17' W/ 2'-0" OVERHANG)		50 (50% MAX OF TOTAL PARKING = 57 COMPACT STALLS ALLOWABLE)
COMPACT STALLS: 9'X16' (14' W/ 2'-0" OVERHANG)		
ADA ACCESSIBLE STALLS:		7 (6 TOTAL ADA STALLS REQ'D PER SANTA ROSA SEC. 20-36.060)
RIDESHARING STALLS (CARPOOL / VANPOOL):		4
EV CHARGING STALLS:		8 (7 EV CHARGING STATIONS REQ'D PER 2019 CALGREEN)
VAN ACCESSIBLE EV STALLS:		1
TOTAL STALLS PROVIDED:		163 = 146 / 1000 S.F.
BICYCLE PARKING STALLS REQ.:		8 (1 BICYCLE PARKING SPACE PER 14,000 G.S.F. OF BUILDING)
(PER SANTA ROSA SEC. 20-36.040)		
LONG TERM BICYCLE STALLS:		1 (PER SANTA ROSA SEC. 20-36.090)
(MIN. 1 LONG TERM REQ'D)		
SHORT TERM BICYCLE PARKING STALLS:		15 (3 RACKS PROVIDED, 5 BIKES EACH)
LONG TERM BICYCLE STALLS:		4 (2 DOUBLE LOCKERS PROVIDED)

SITE LEGEND:

- BUILDING AREA
- ASPHALT AREA
- SITE CONCRETE
- LANDSCAPE AREA
- STORM WATER RETENTION AREA
- EXISTING PROPERTY LINE
- 9' X 10' OVERHEAD DOCK LEVEL DOOR
- 12' X 14' OVERHEAD GRADE LEVEL DOOR

FIRE DEPARTMENT TURN RADIUS:

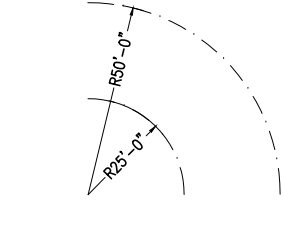

KEYNOTES:

- 1 EXISTING PROPERTY LINES.
- 2 EXISTING SEWER LINE, SEE CIVIL DRAWINGS
- 3 STRIPPED PATH OF TRAVEL TO TRASH ENCLOSURE
- 4 PARKING AISLE TO BE PERVIOUS ASPHALTIC CONCRETE, SEE CIVIL DRAWINGS FOR MORE INFO
- 5 TYPICAL 6" TALL X 6" WIDE CONCRETE CURBS, SEE CIVIL DRAWINGS
- 6 TYPICAL 4" WIDE TRAFFIC STRIPING
- 7 TYPICAL PARKING:
 - A. STANDARD STALLS: 9' X 19' OR 9' X 17' WITH 2" PARKING OVERHANG
 - B. COMPACT STALLS: 8' X 16' OR 8' X 14' WITH 2" PARKING OVERHANG (35% MAX)
 - C. ACCESSIBLE PARKING STALLS: 9' X 18' MIN. WITH 2" PARKING OVERHANG WITH 5' OR 8' WIDE LOADING ZONE AS SHOWN SEE DETAIL 12 SHEET A01.1
 - D. DESIGNATED PARKING PER CAL-GREEN REQUIREMENTS FOR CAR/VAN POOL, FUEL EFFICIENT, EV & LOW-EMITTING VEHICLES.
 - E. ELECTRIC VEHICLE CHARGING SPACES (STALLS LABELED "ELECTRIC VEHICLE CHARGING"), PER CGSB 5.106.5.2, TO FACILITATE FUTURE INSTALLATION CONDUIT, RING AND STRING SHALL BE INSTALLED AT THIS TIME AS PART OF THE SHELL CONSTRUCTION.
 - F. ACCESSIBLE ELECTRIC VEHICLE CHARGING STALL, 1 VAN, 1 STANDARD. (RING AND STRING ONLY)
 - G. MOTORCYCLE PARKING STALLS: 4 SPACES PER 1 STANDARD PARKING STALL.
 - H. BICYCLE PARKING: 75" X 39" SECURED BIKE LOCKERS, 2 BIKES PER LOCKER, STANDARD TUBING BIKE RACK, MIN. 6 BIKES.
- 8 TYPICAL DRIVE ISLE, 26'-0" WIDE MINIMUM
- 9 CURB RAMP, SEE DETAIL 9/A01.1
- 10 PROPOSED LOCATION OF NEW SITE ACCESS DRIVE CURB CUT, SEE CIVIL DRAWINGS
- 11 NEW CONCRETE PEDESTRIAN WALKS ASSUME ALL SIDEWALKS TO BE ACCESSIBLE PATH OF TRAVEL. SLOPE NOT TO EXCEED 1:20 (5%) IN DIRECTION OF TRAVEL. CROSS SLOPE NOT TO EXCEED 1:50 (2%) WHERE PARKING OVERHANG OCCURS, INCREASE WIDTH OF SIDEWALK TO 6'-0" MIN.
- 12 PROPOSED BUILDING EXTERIOR WALLS TO BE SITE CAST TILTED CONCRETE WALLS WITH REVEALS, A TEXTURED ELASTOMERIC COATING AND A MULTI-COLOR PAINT PALLET. SEE EXTERIOR ELEVATIONS, SHEET A03.1.
- 13 TRASH ENCLOSURE W/ 40FT. APPROACH, SEE DETAILS 1 & 2/A01.1
- 14 TYPICAL LANDSCAPE PLANTER AREA, SEE LANDSCAPE DRAWINGS
- 15 SEMI TRACTOR TRAILER TEMPLATE SHOWN FOR REFERENCE ONLY
- 16 60" DEPRESSED CONCRETE TRUCK DOCK
- 17 LOADING DOCK VERTICAL LIFT DOORS, TYPICAL
- 18 GRADE LEVEL VERTICAL LIFT DOORS, TYPICAL
- 19 GREEN DASHED LINE INDICATES ACCESSIBLE PATH OF TRAVEL AT PUBLIC SIDEWALK, TYP.
- 20 LOCATION OF SITE ENTRY SIGN REGARDING PARKING IN ACCESSIBLE PARKING STALLS. SEE DETAIL 15/A01.1
- 21 CURB WITH GUARDRAIL AT EACH SIDE OF LOADING DOCKS, WITH 6" CURB PAINTED "SAFETY YELLOW", TYP. SEE DETAIL 18/A01.1
- 22 STORM WATER RETENTION BASIN, SEE CIVIL DRAWINGS
- 23 BICYCLE STORAGE LOCKER AND RACKS, SEE DETAILS 10 & 14/A01.1
- 24 RED DASHED LINE INDICATES FIRE LANES. FIRE LANES TO BE MARKED WITH SIGNS EVERY 50 FEET STATING "NO PARKING FIRE LANE" PER SACRAMENTO METROPOLITAN FIRE DISTRICT STANDARDS.
- 25 DASH-DOT INDICATES AREA OF ASSISTED RESCUE
- 26 LANDSCAPE SETBACK, SEE LANDSCAPE DRAWINGS.
- 27 DASH-DOT LINE INDICATES FIRE DEPARTMENT TURNING RADIUS. SEE FIRE TURN RADIUS DIAGRAM 17/A01.1
- 28 SITE LIGHTING 16' MAX. HEIGHT, SEE PHOTOMETRIC PLANS
- 29 DASHED LINE INDICATED 2'-0" PARKING OVERHANG.
- 30 PROPOSED TRUCK ACCESS DRIVE AISLE
- 31 EXISTING STREET LIGHT, TO BE RELOCATED.
- 32 TYPICAL EXISTING UTILITIES, SEE CIVIL DRAWINGS.
- 33 EXISTING FIRE HYDRANTS, SEE CIVIL DRAWINGS
- 34 EXISTING MONITORING WELLS, SEE CIVIL DRAWINGS
- 35 EXISTING ELECTRICAL TRANSFORMER AND PG&E, SEE CIVIL DRAWINGS
- 36 TRASH/ RECYCLE RECEPTACLES AT BUILDING ENTRY AREAS.
- 37 PROPOSED MONUMENT SIGN, SEE DETAIL 6/A01.5 FOR MORE INFO
- 38 PROPOSED NEW SIDEWALK, SEE CIVIL AND LANDSCAPE DRAWINGS



RMW Architecture Interiors
1718 Third Street Suite 101 Sacramento California 95811

Office
916 449-1400

rmw.com

CLIENT:
McNeill Real Estate Services
Joseph A McNeill, III
916 718 5659
Ca DRE # 01138862

PRELIMINARY DESIGN DOCUMENTS FOR:
NORTHPOINT COMMERCE CENTER
NORTHPOINT PARKWAY AT THUNDERBOLT WAY SANTA ROSA, CALIFORNIA

approved for the owner by:
approved for the architect by:
issue : description : date :
A ISSUED FOR REVIEW 03-21-2023

drawn by : TLG plot date : 09-03-2021

checked by : AGUIDL



scale : AS NOTED
project number : 2204025.00

PRELIMINARY SITE PLAN

sheet no. : **A01.0**

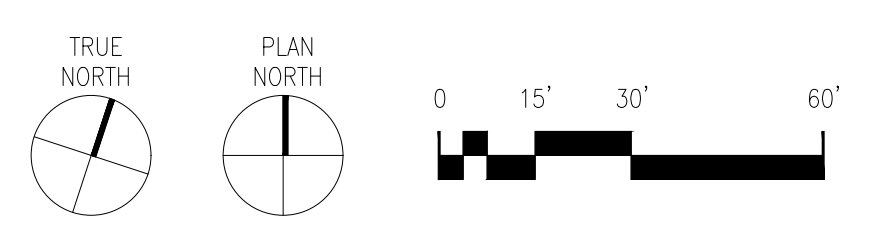

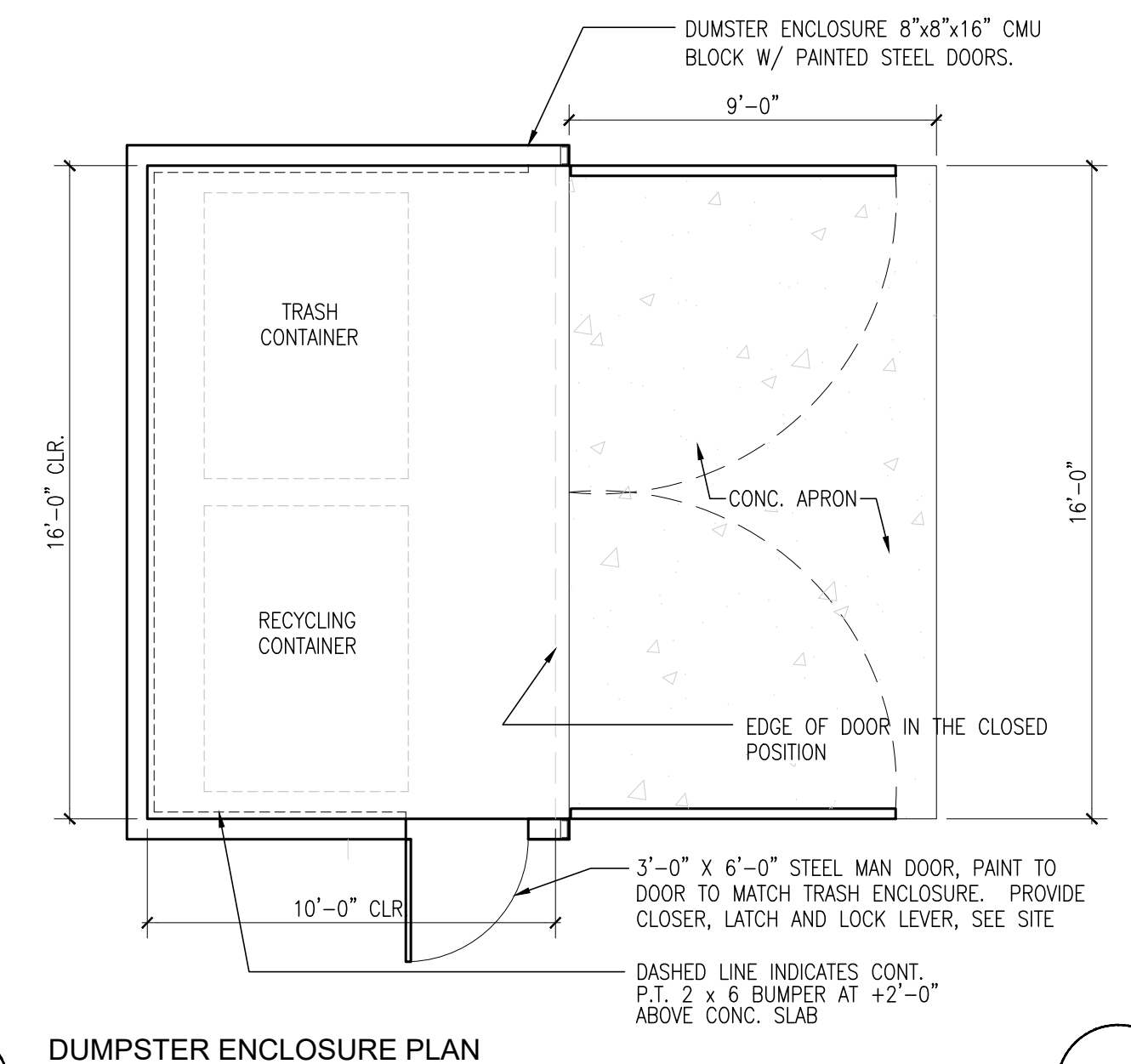

DUMPSTER ENCLOSURE PLAN
SCALE: 1/4" = 1'-0"

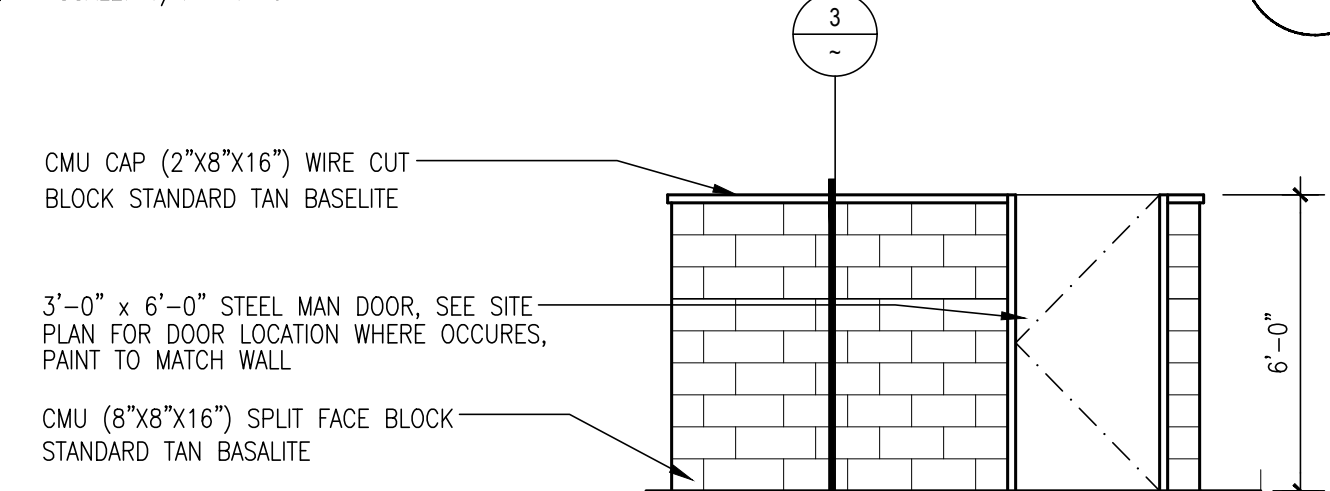

DUMPSTER ELEVATIONS
SCALE: 1/4" = 1'-0"

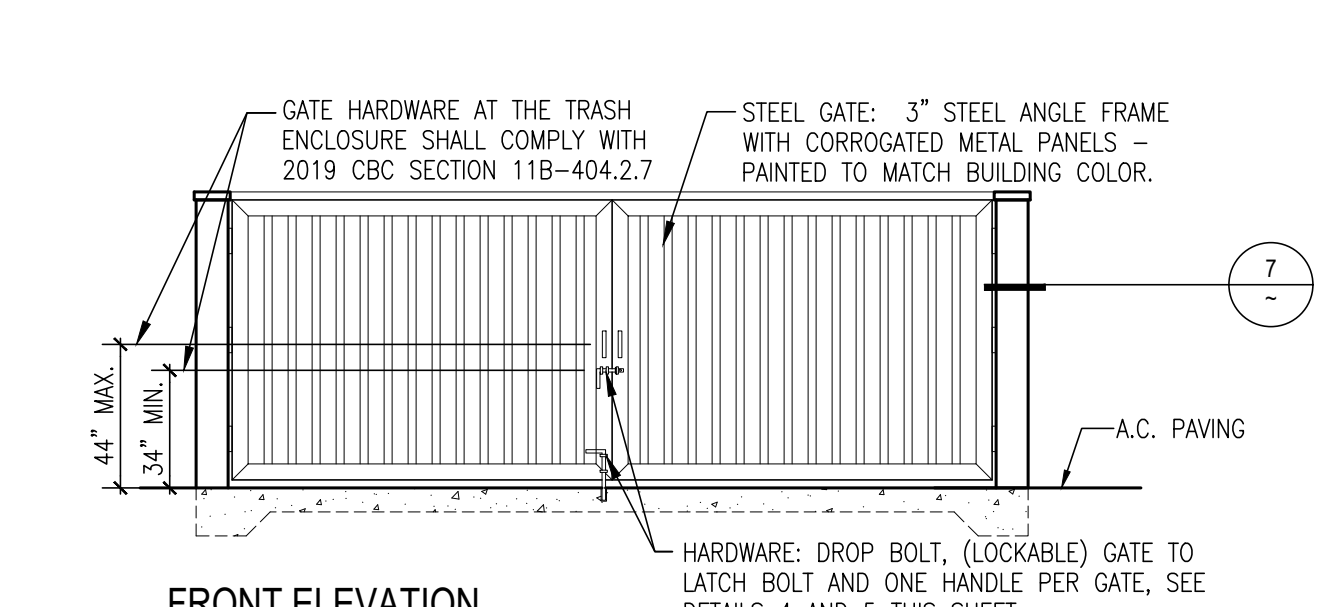

DUMPSTER ELEVATIONS
SCALE: 1/4" = 1'-0"

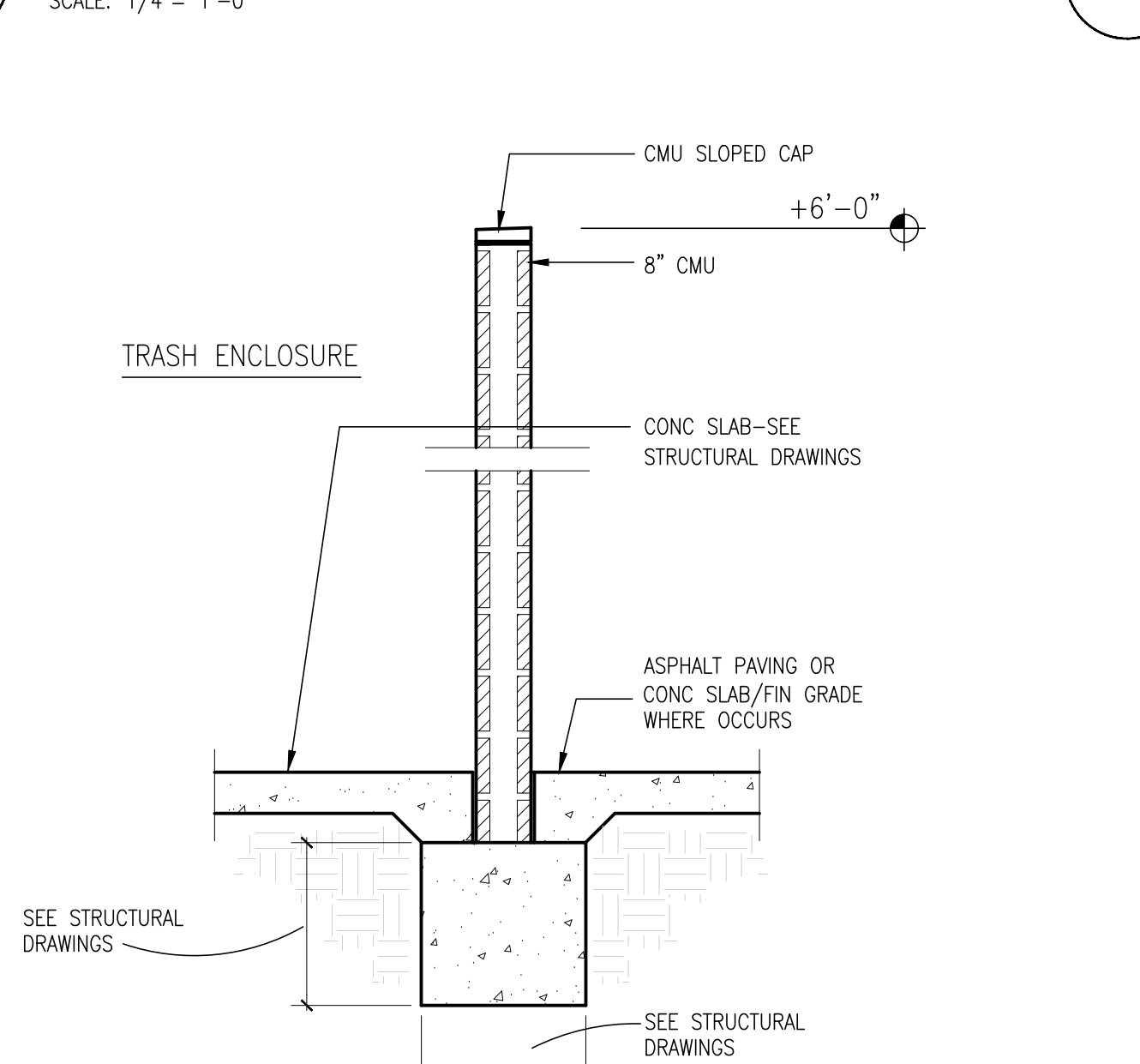

TRASH ENCLOSURE WALL SECTION
SCALE: 1/2" = 1'-0"

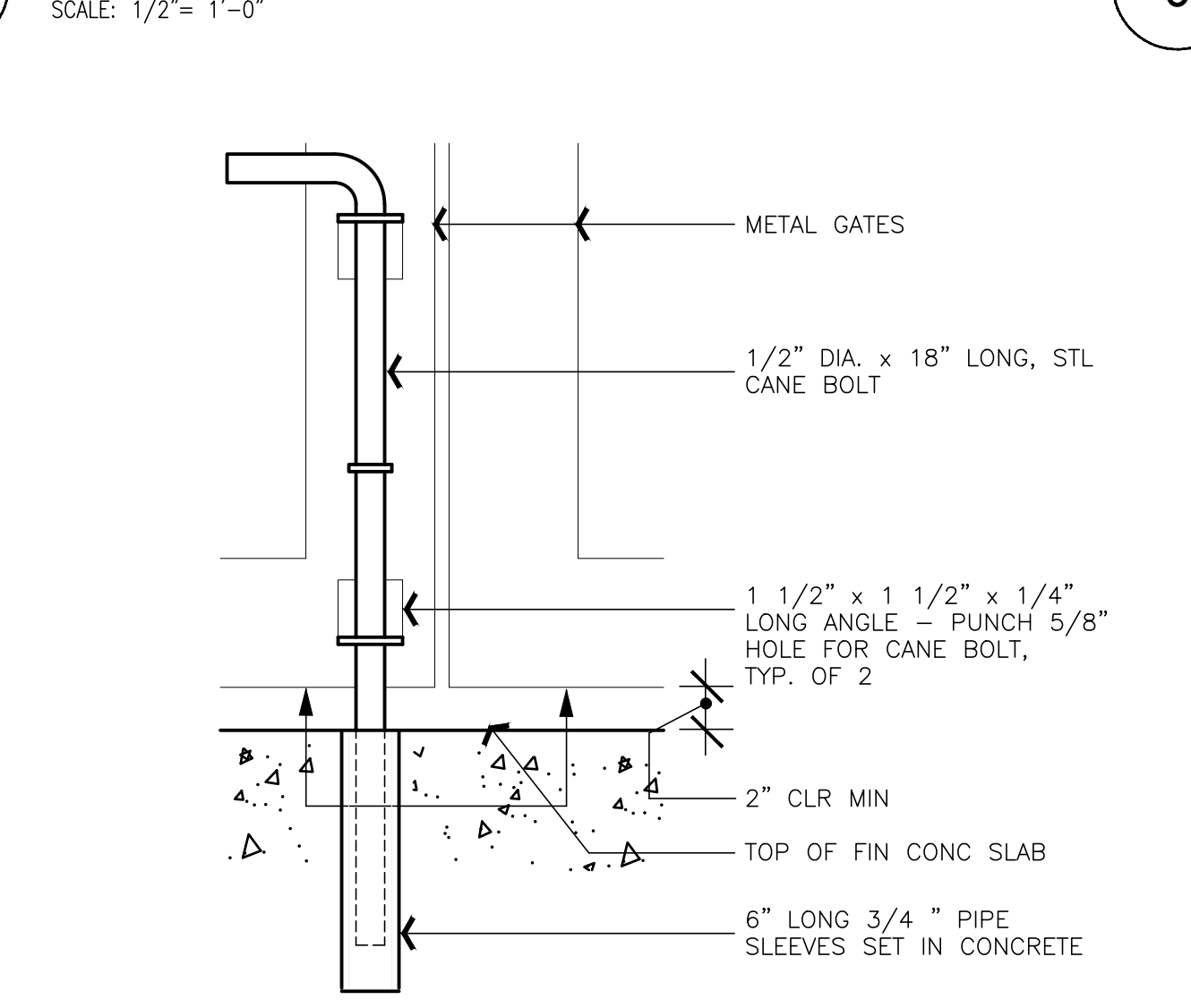

CANE BOLT SECTION
SCALE: 3" = 1'-0"

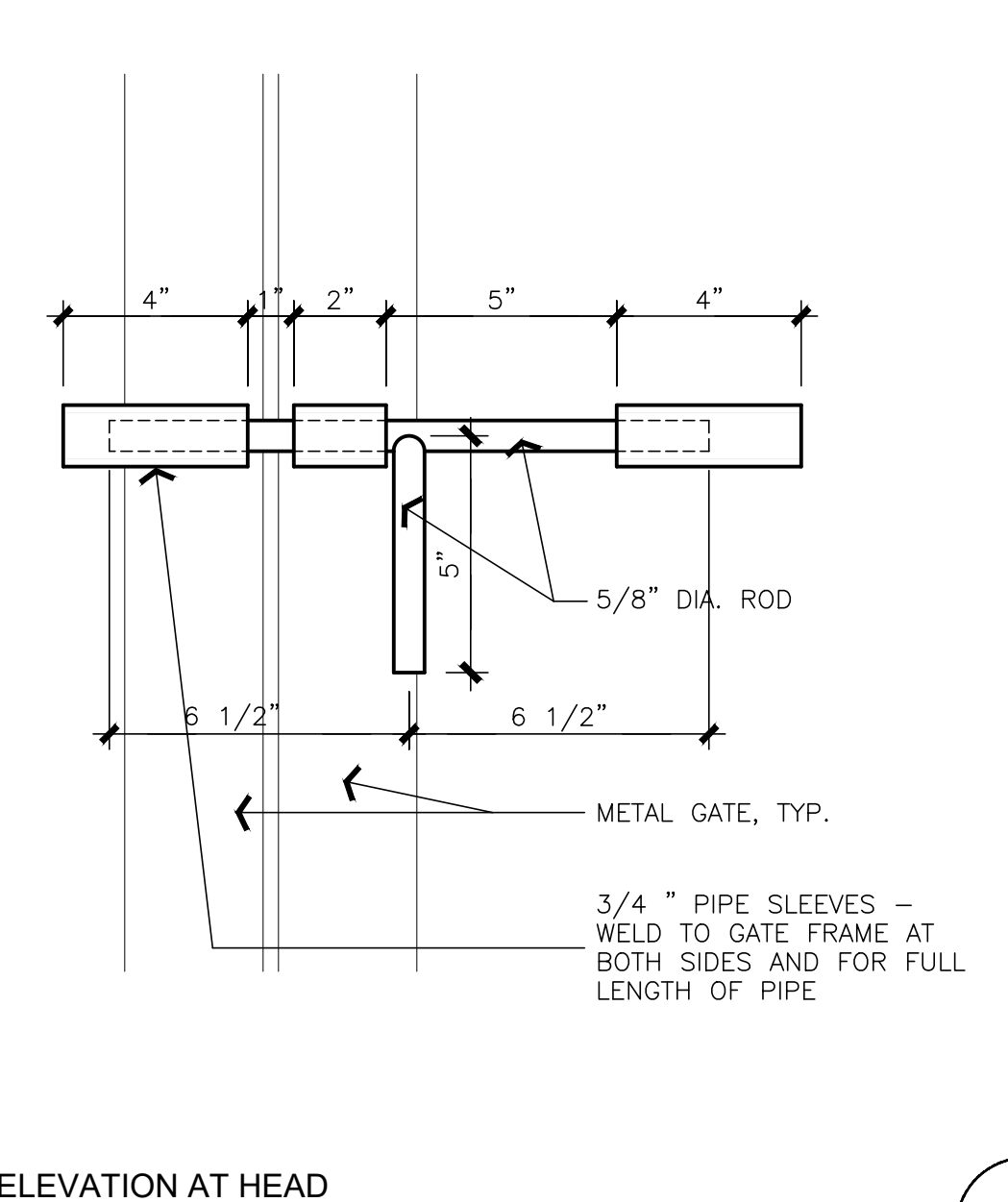

SIDE BOLT ELEVATION AT HEAD
SCALE: 3" = 1'-0"

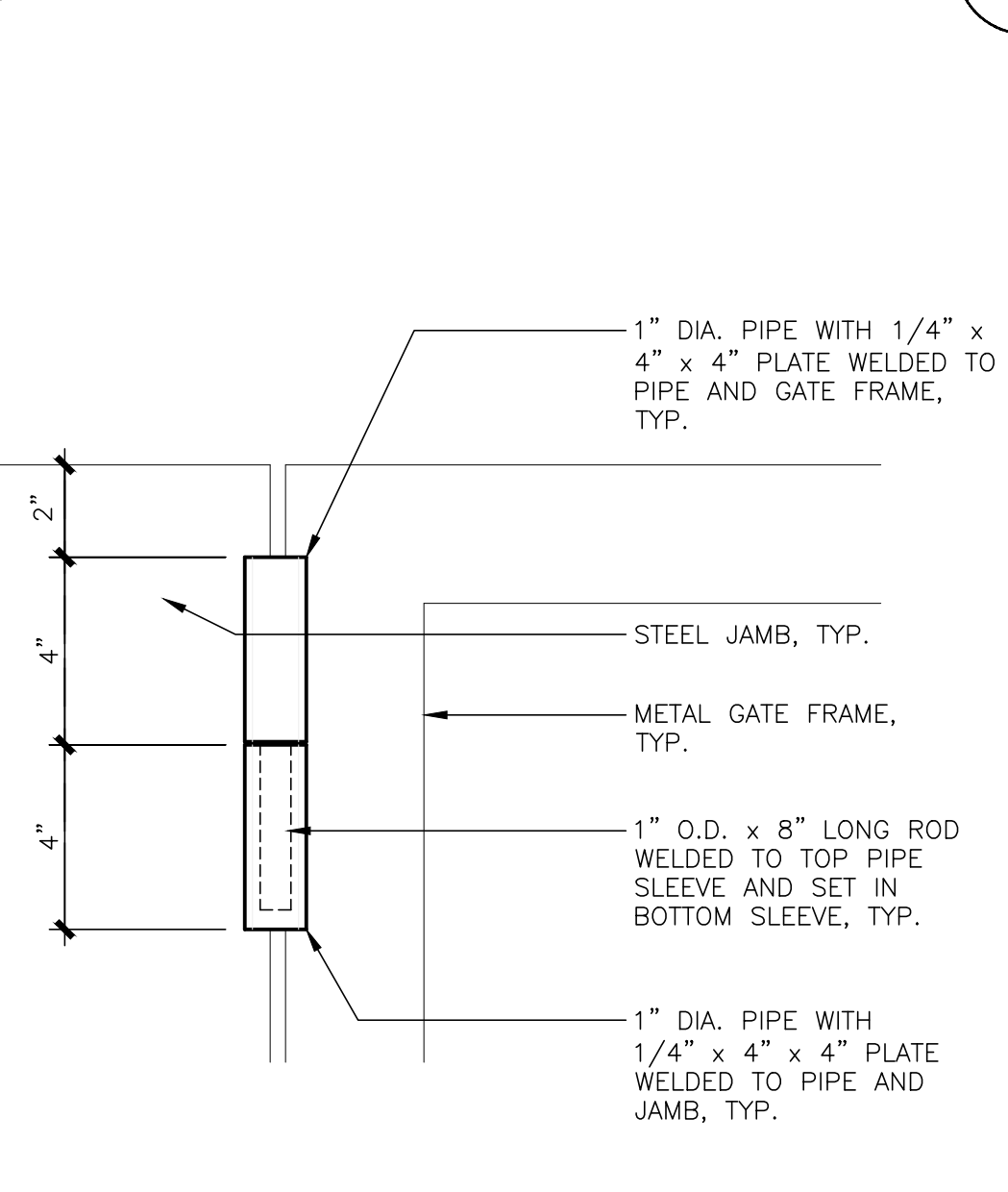

HINGE ELEVATION, TYP.
SCALE: 3" = 1'-0"

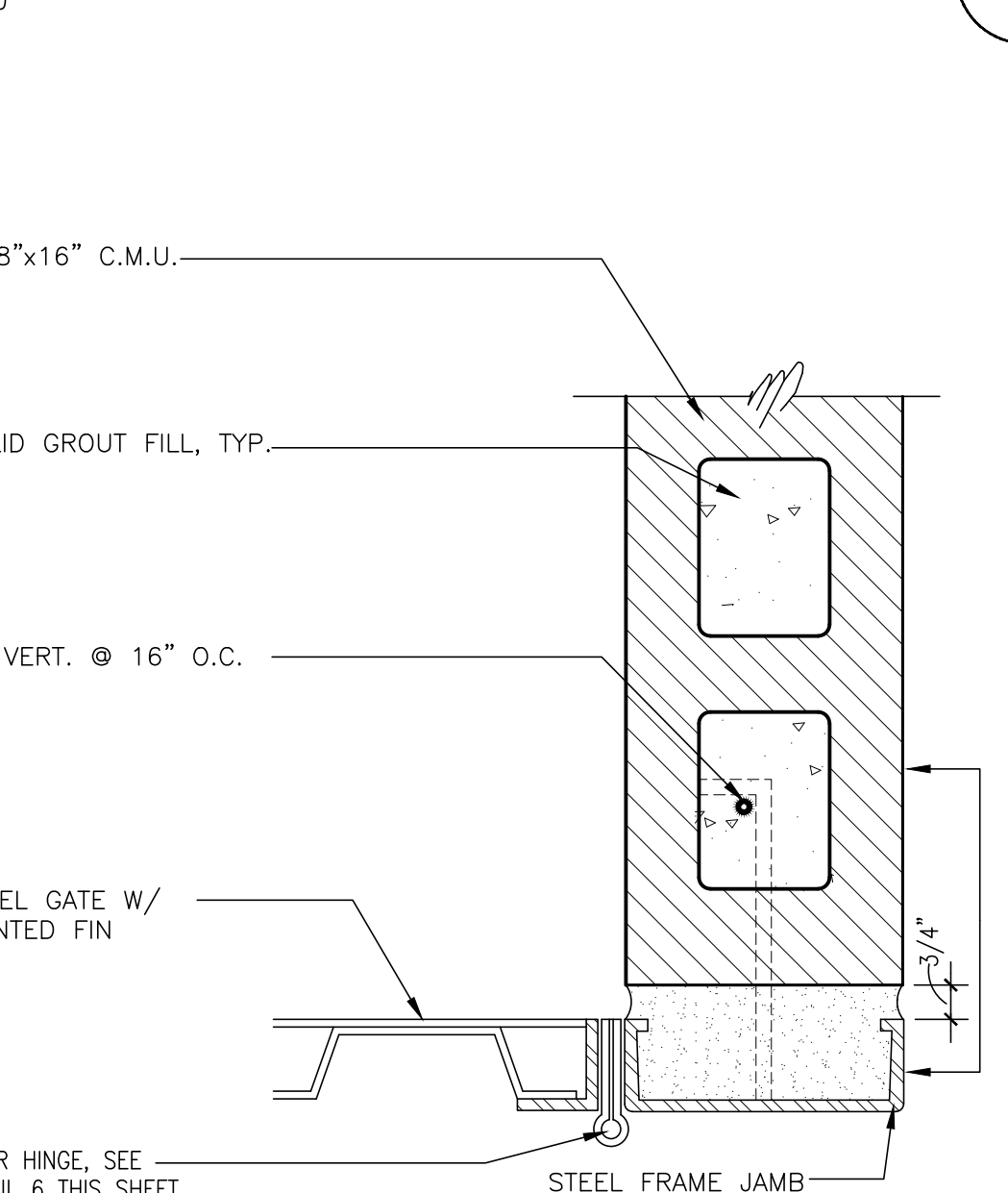

GATE JAMB
SCALE: 3" = 1'-0"

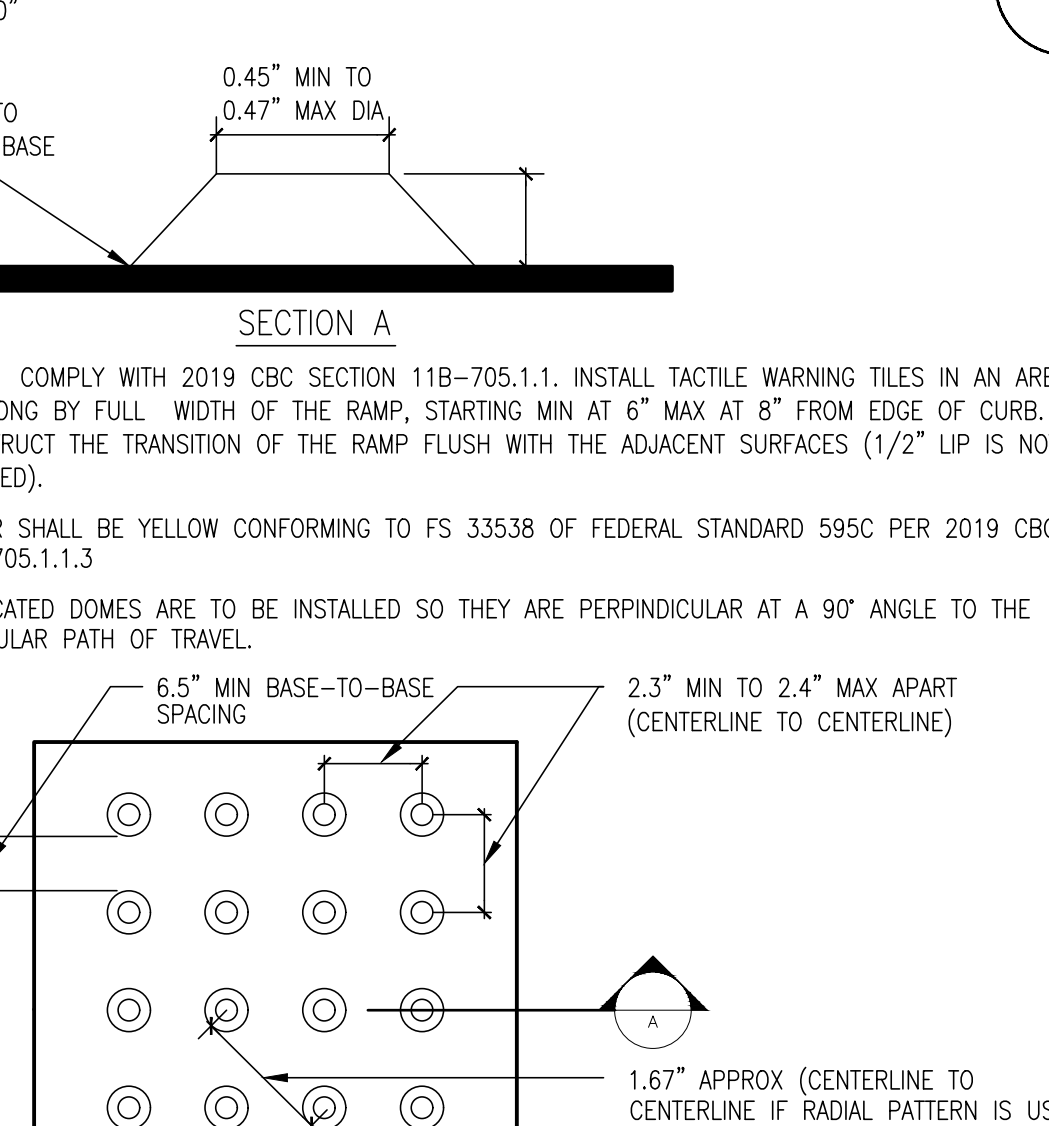

WARNING DOMES AT SITE RAMPS
SCALE: N.T.S.

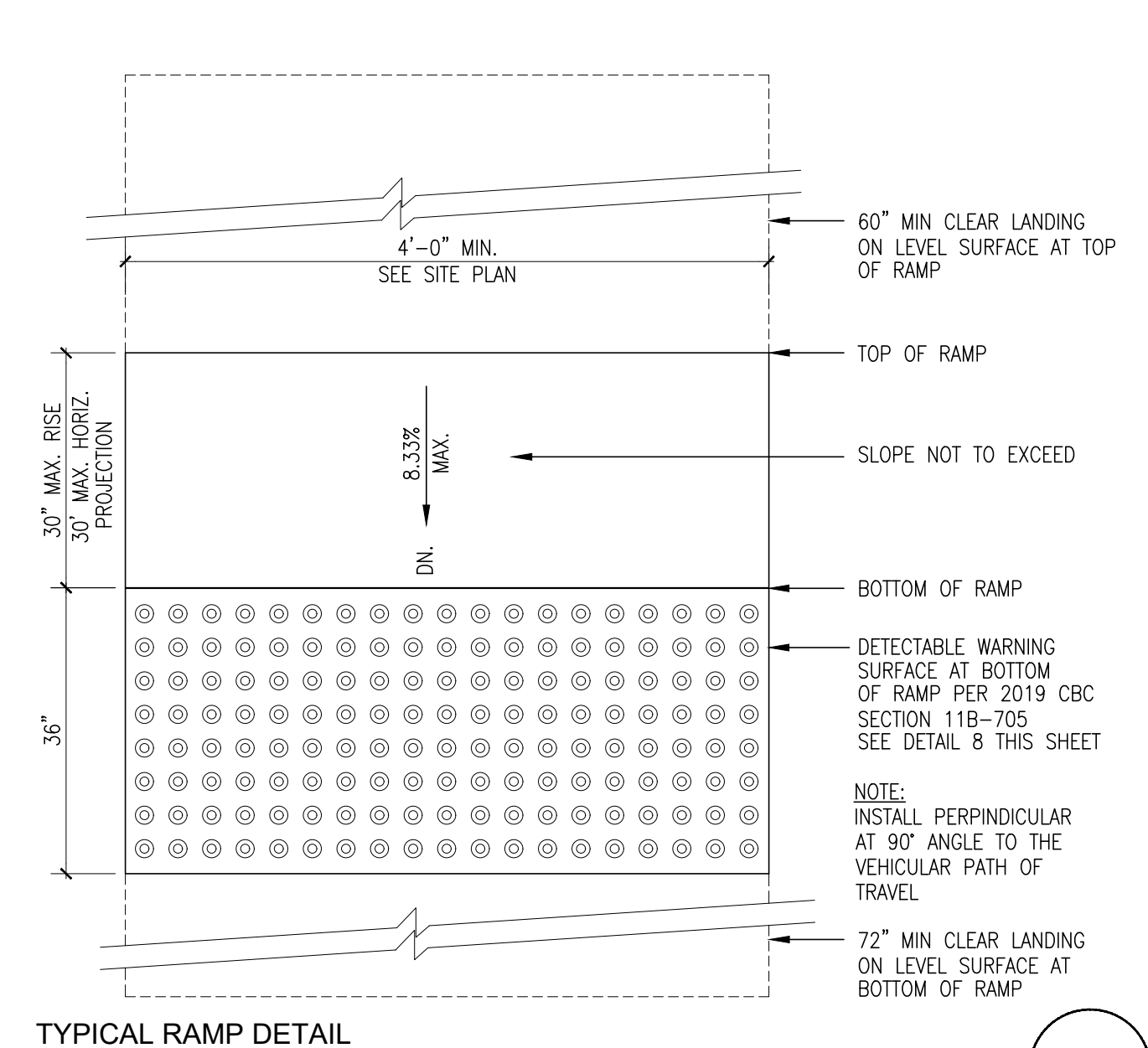

TYPICAL RAMP DETAIL
SCALE: 1" = 1'-0"

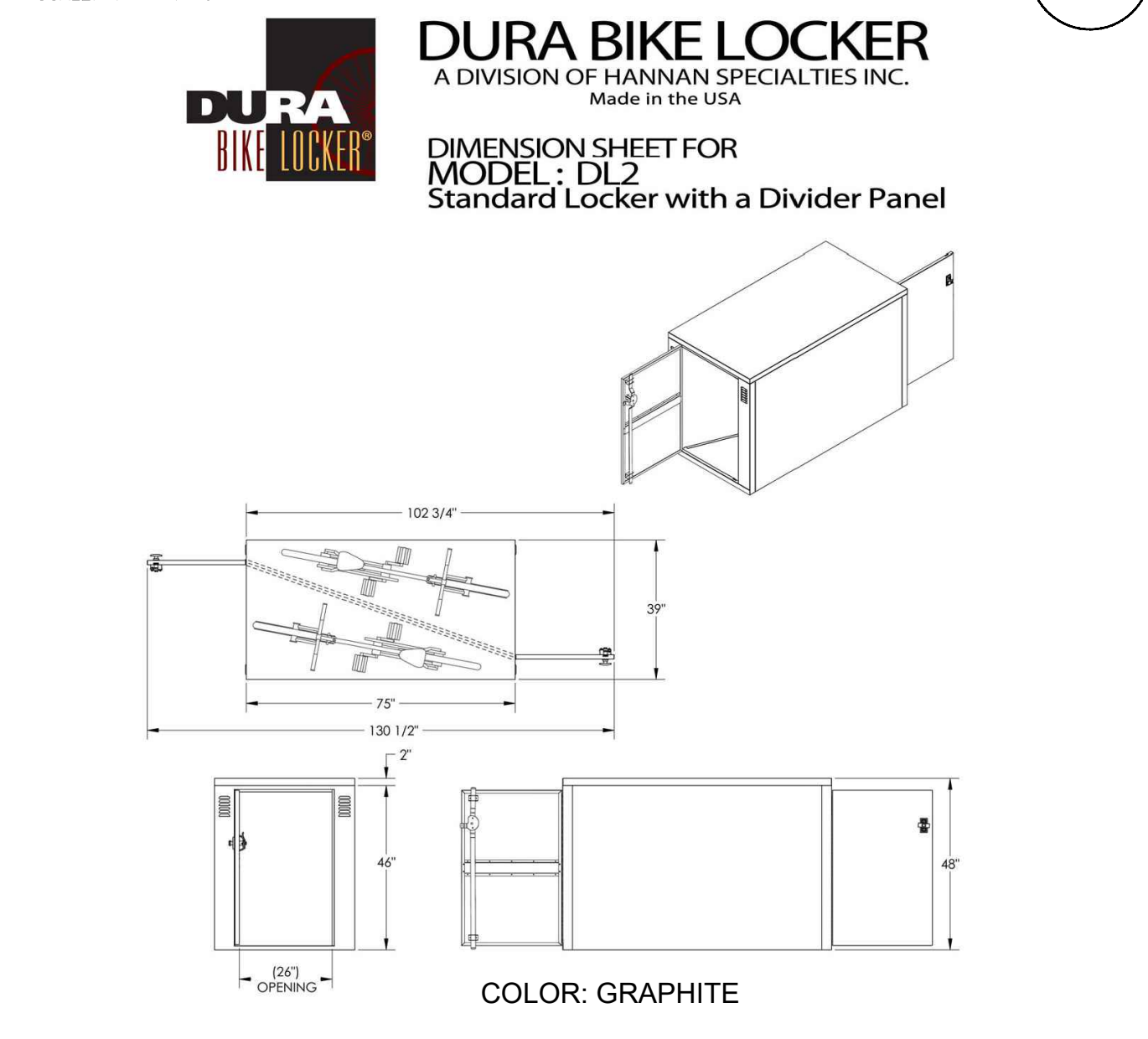

BIKE LOCKER - DOUBLE
SCALE: N.T.S.

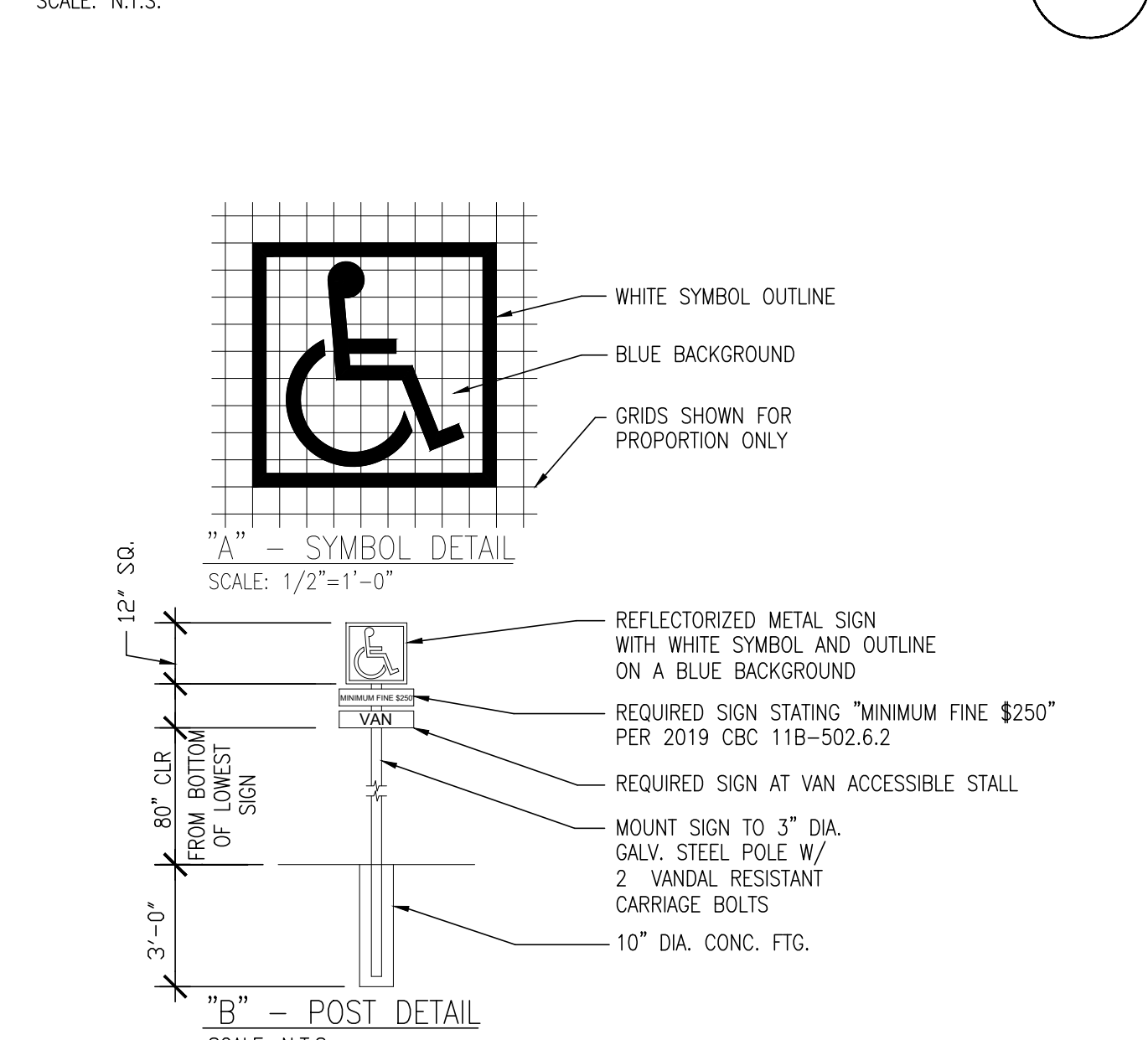

SIGN AT ACCESSIBLE PARKING STALLS
SCALE: NO SCALE

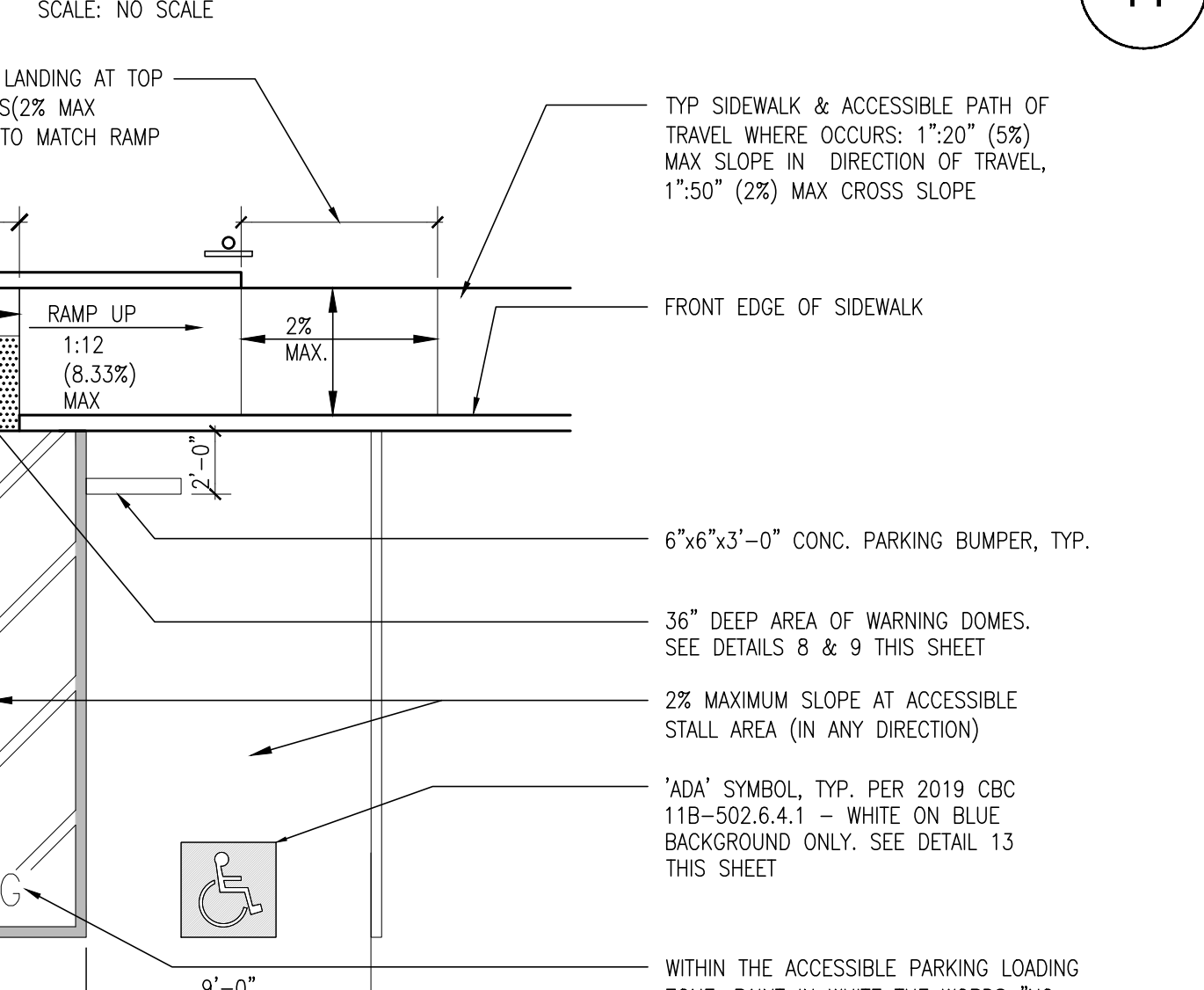

DOUBLE ACCESSIBLE STALLS
SCALE: 3/16" = 1' - 0"

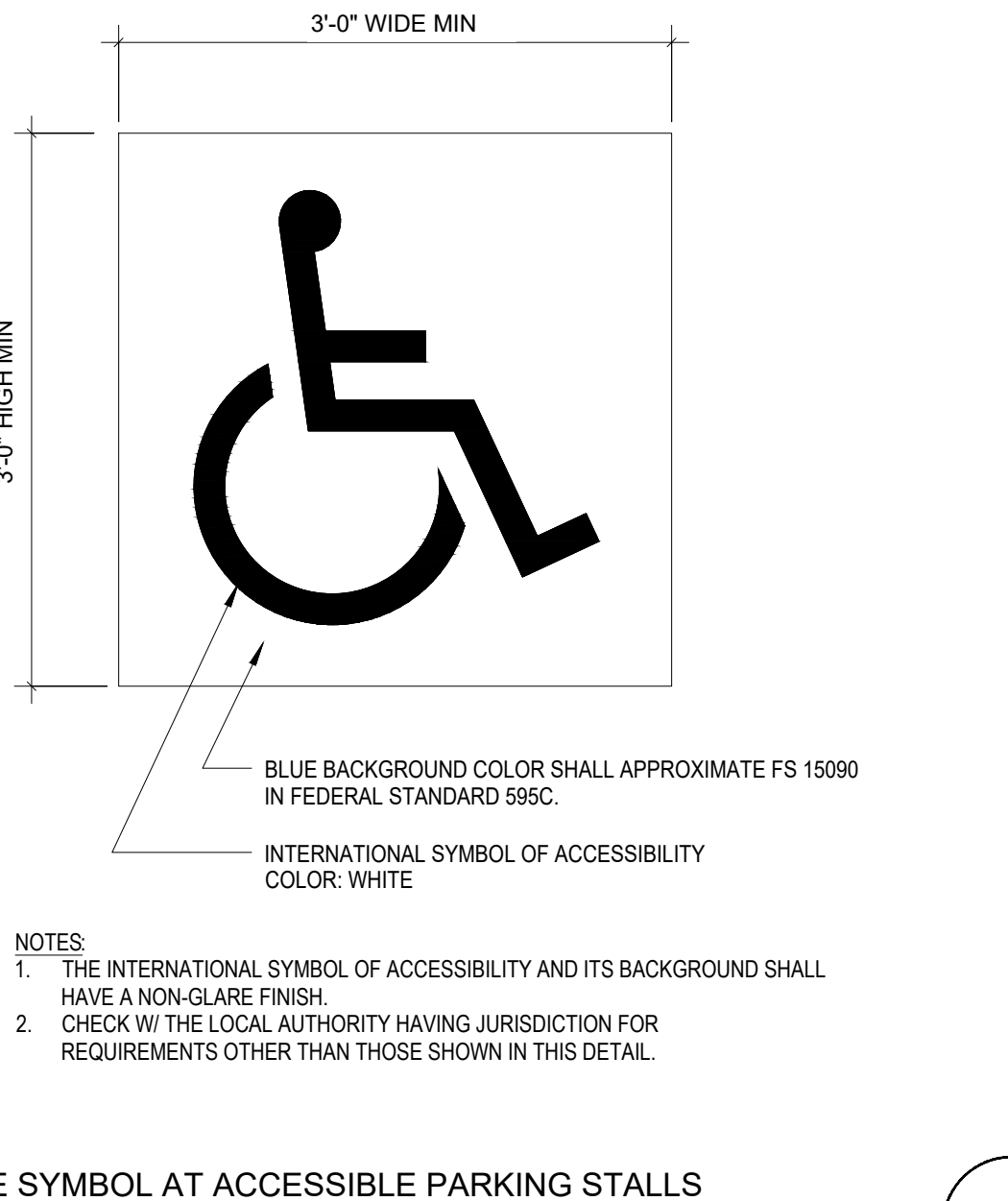

ACCESSIBLE SYMBOL AT ACCESSIBLE PARKING STALLS
SCALE: 1" = 1'-0"

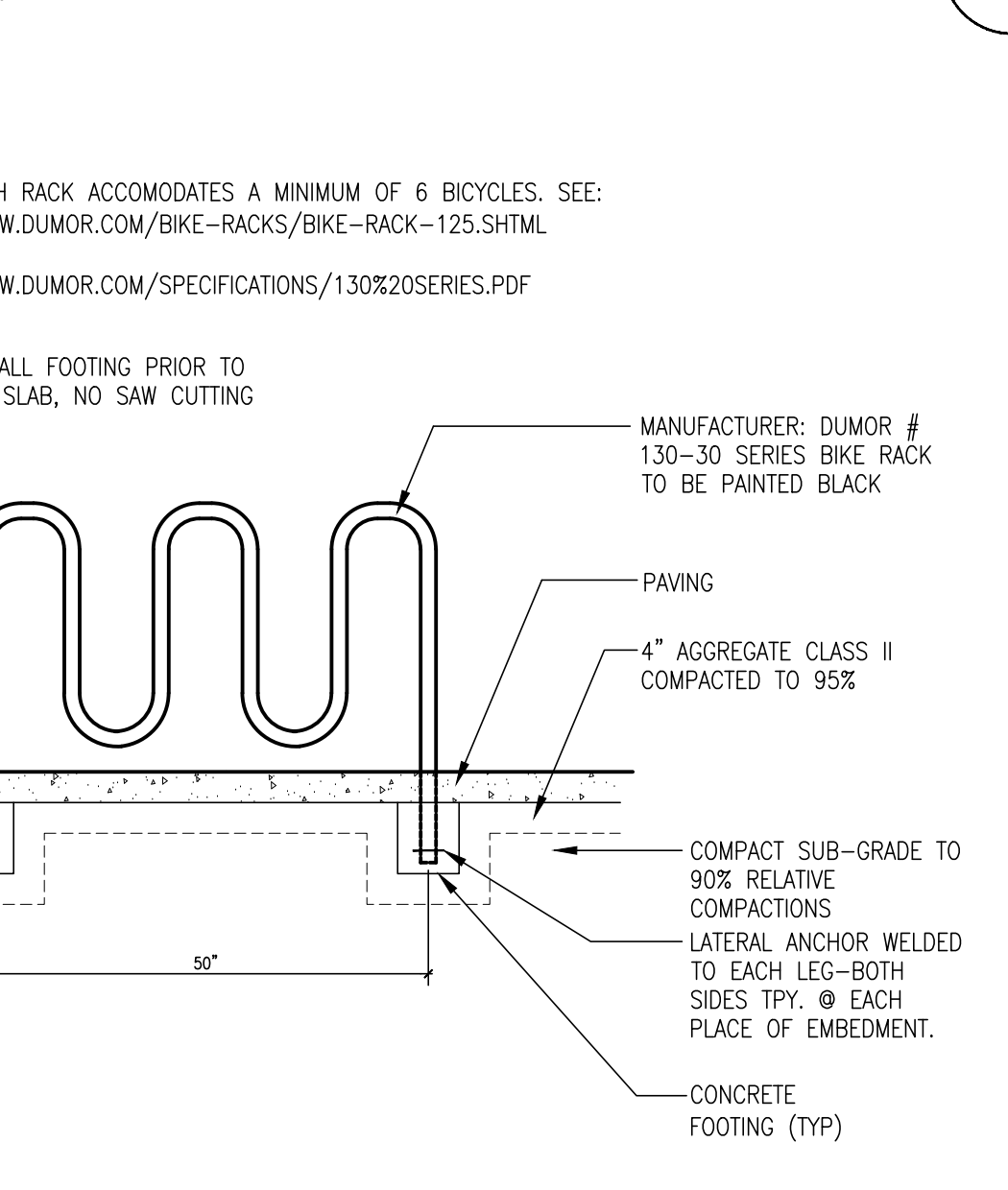

BIKE RACK
SCALE: 1/2" = 1'-0"

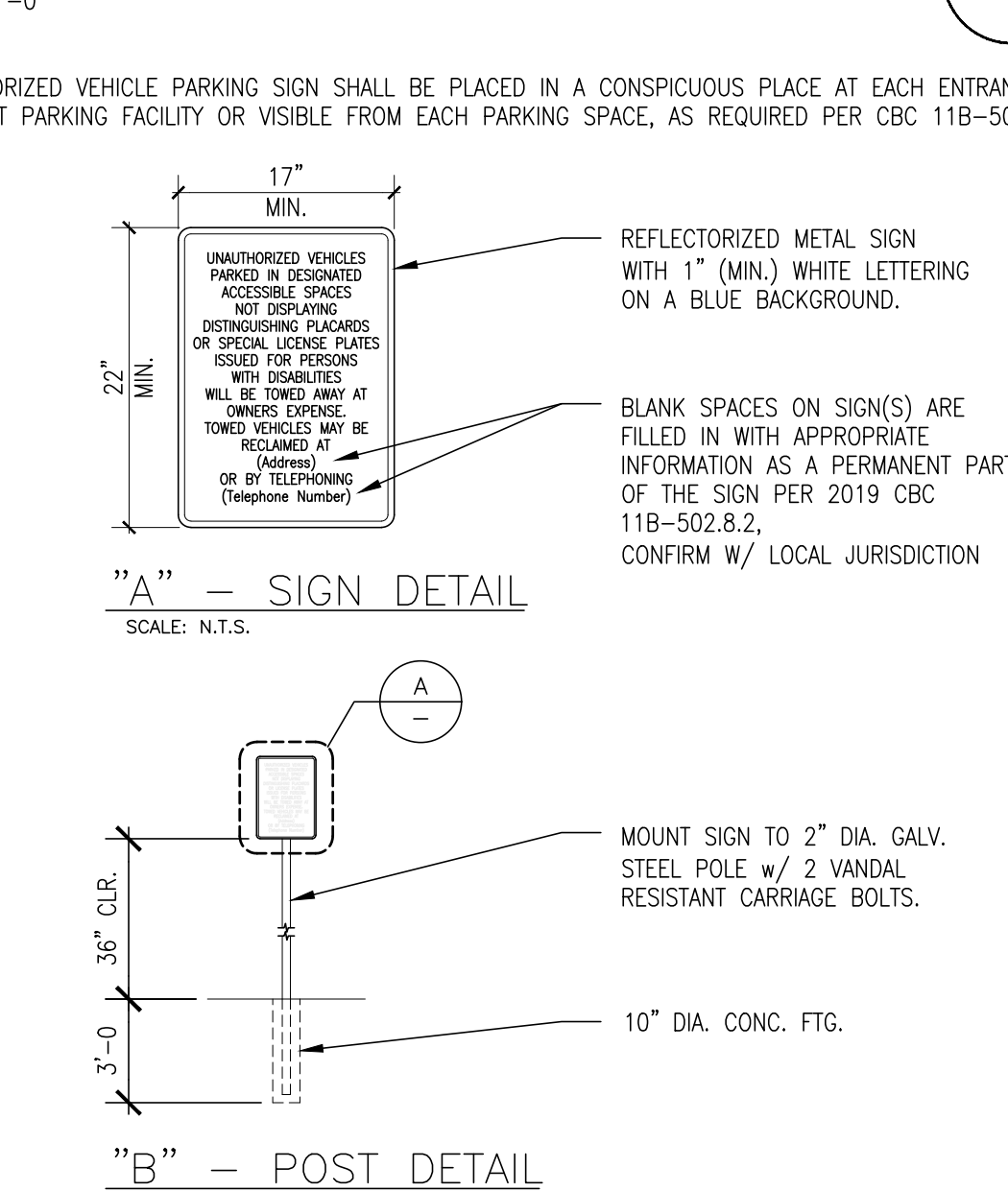

SITE ENTRY ACCESSIBLE SIGN
SCALE: 3/16" = 1'-0"

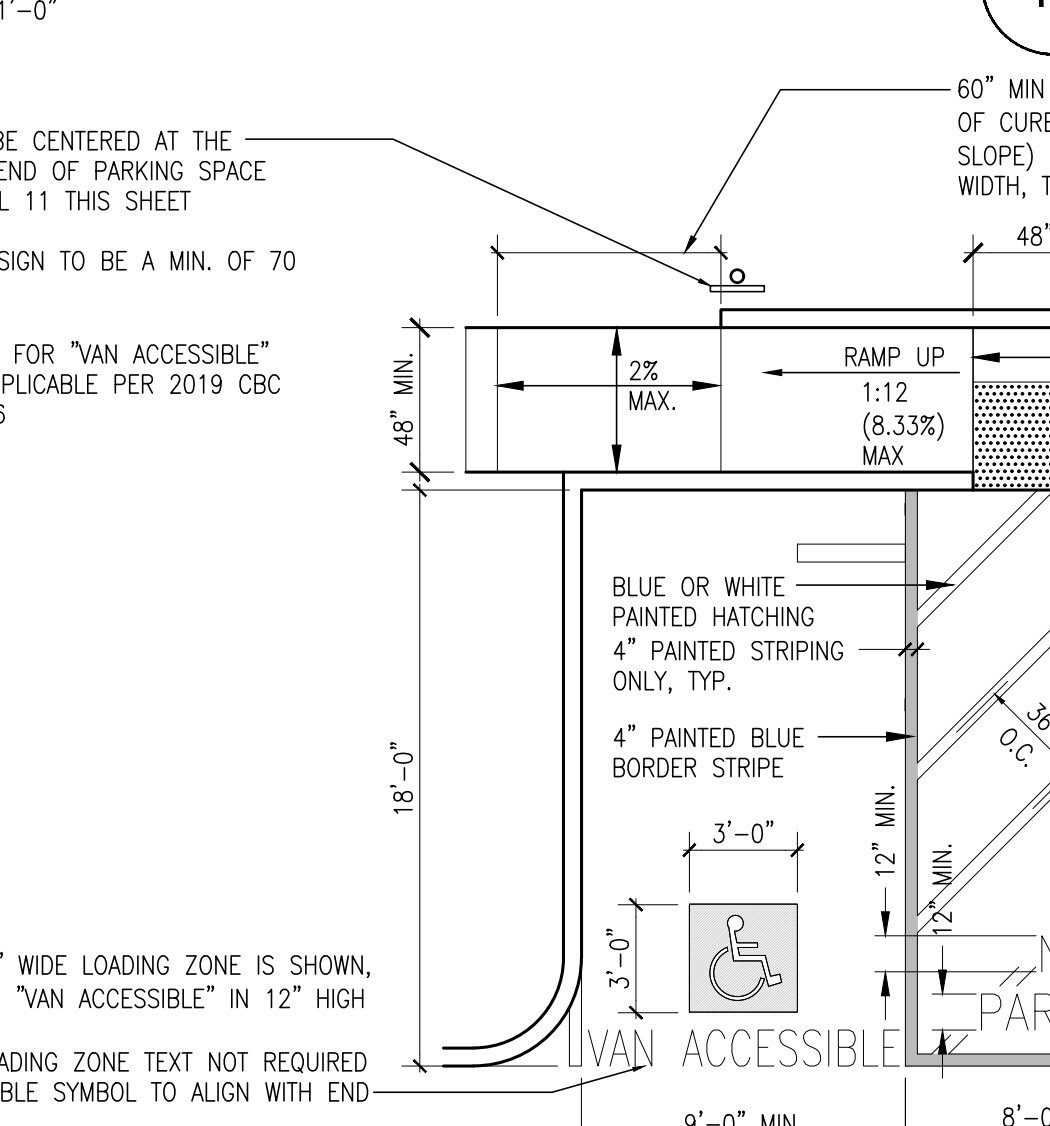

GUARDRAIL
SCALE: 1" = 1'-0"

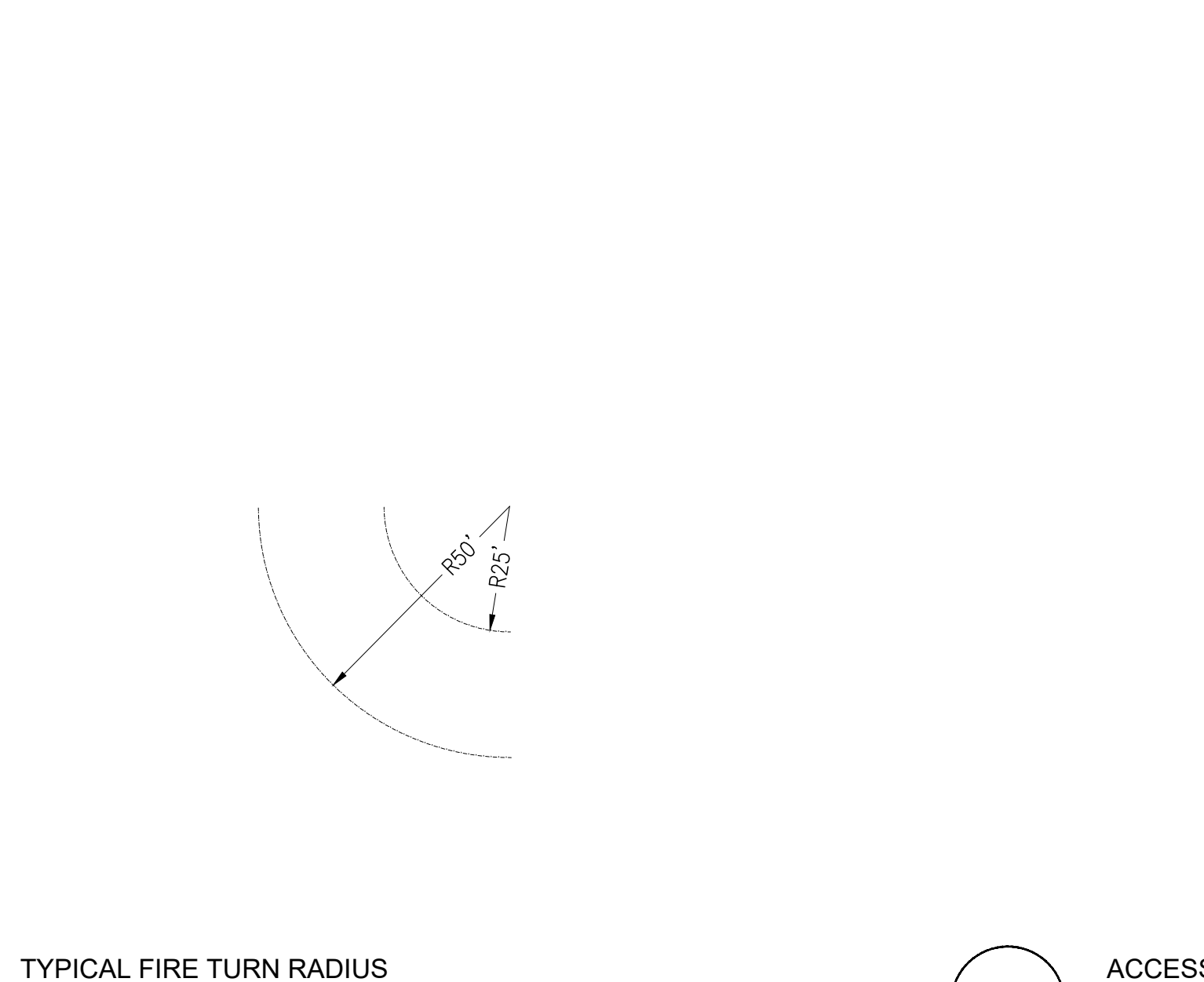

TYPICAL FIRE TURN RADIUS
SCALE: 1" = 30'-0"

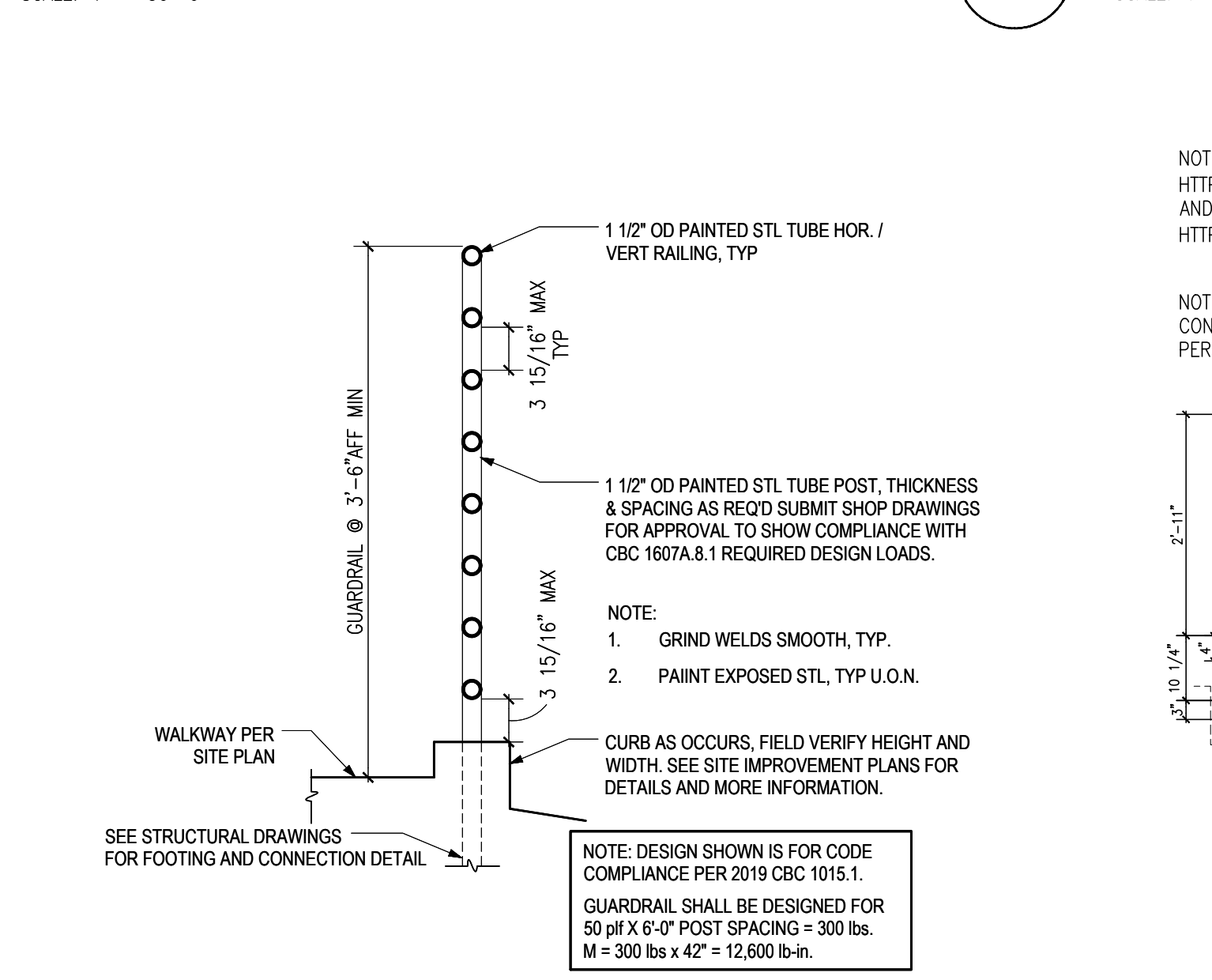

GUARDRAIL
SCALE: 1" = 1'-0"

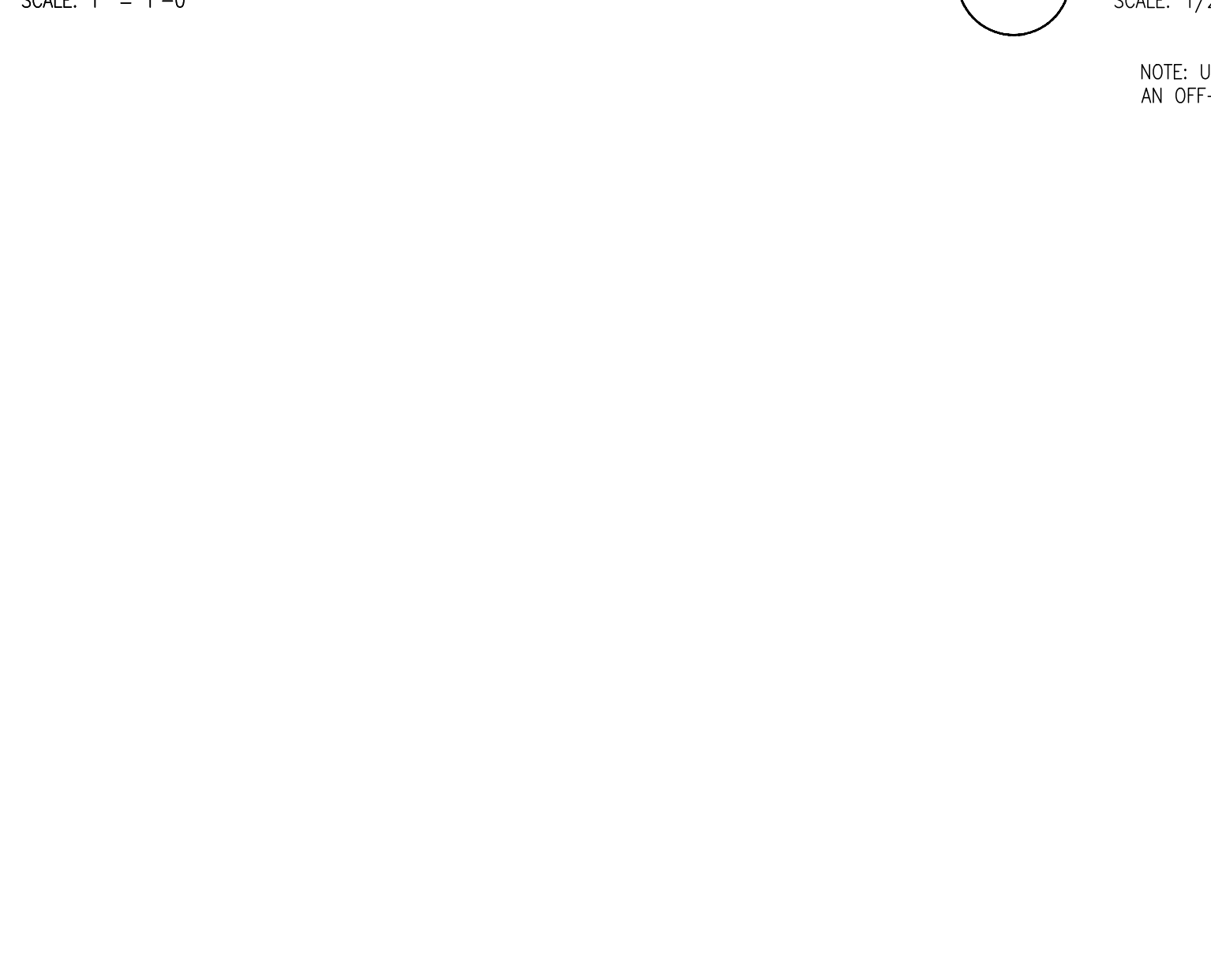

GUARDRAIL
SCALE: 1" = 1'-0"



GUARDRAIL
SCALE: 1" = 1'-0"

CLIENT:

McNeill Real Estate Services
Joseph A McNeill, III

916 718 5659
Ca DRE # 01138862

PRELIMINARY DESIGN DOCUMENTS FOR:

NORTHPOINT COMMERCE CENTER

NORTHPOINT PARKWAY AT THUNDERBOLT WAY
SANTA ROSA, CALIFORNIA

approved for the owner by:

approved for the architect by:

issue :	description :	date :
A	ISSUED FOR REVIEW	03/21/2023

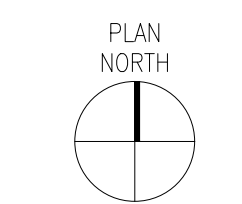
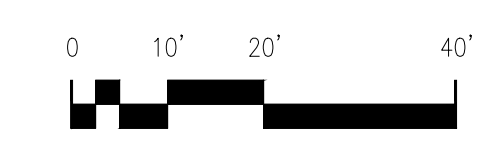
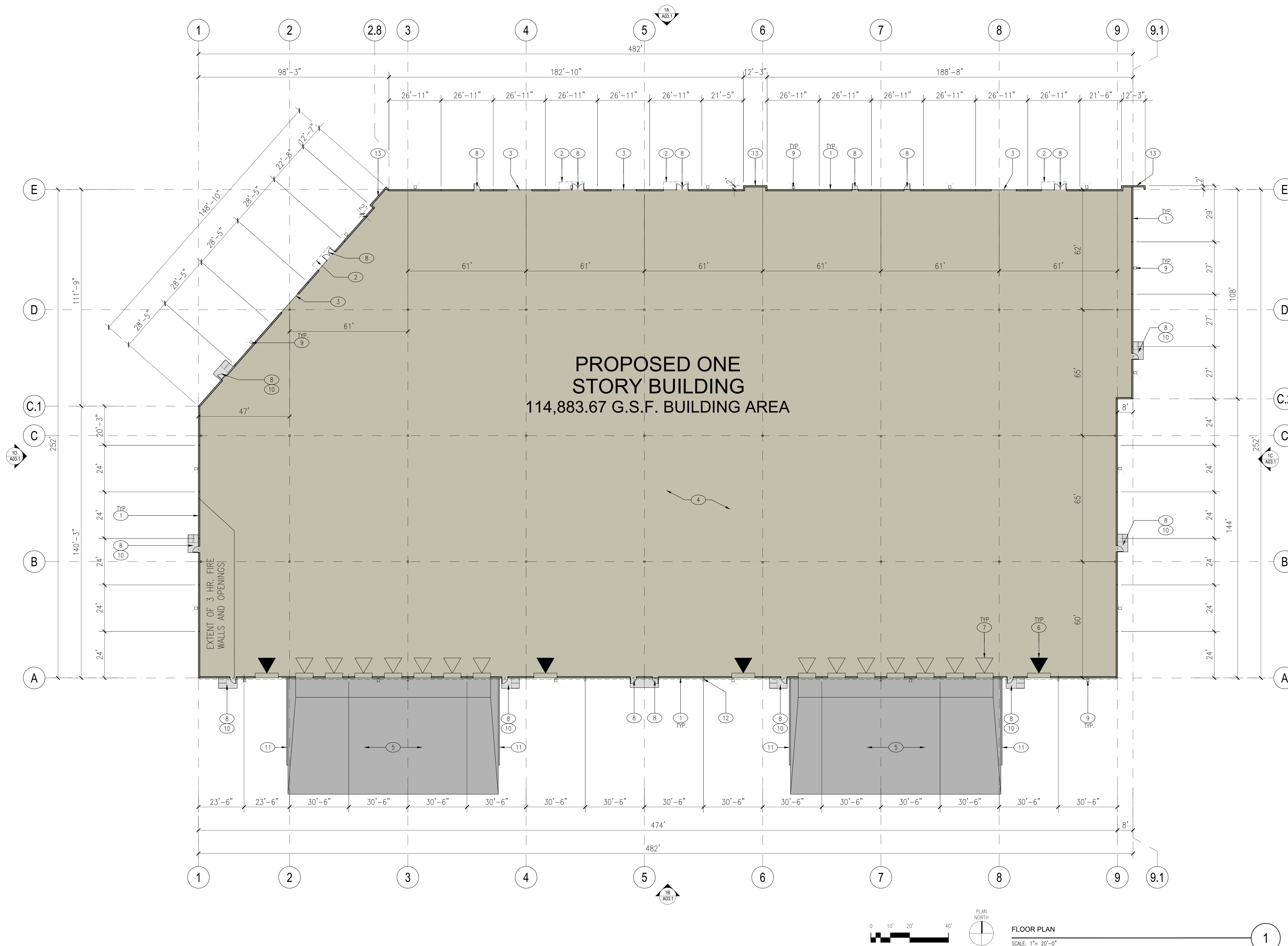

FLOOR PLAN
SCALE: 1" = 20'-0"

1

KEYNOTES:

- 1 TYPICAL EXTERIOR WALLS TO BE TILT-UP CONCRETE WITH REVEALS AND A MULTICOLORED TEXTURED ELASTOMERIC FINISH SYSTEM. SEE EXTERIOR ELEVATIONS, SHEETS A03.1
- 2 LINE OF ENTRY CANOPY ABOVE, SEE EXTERIOR ELEVATIONS, SHEETS A03.1
- 3 TINTED GLAZING IN ALUMINUM FRAMES
- 4 CONCRETE FLOOR SLAB
- 5 DEPRESSED CONCRETE TRUCK DOCK
- 6 12' X 14' GRADE LEVEL ROLL UP DOOR
- 7 9' X 10' DOCK LEVEL ROLL UP DOOR
- 8 3' X 7' STEEL MAN DOOR, WHERE DOORS ARE SHOWN AT GLAZING, DOORS TO BE STOREFRONT DOORS
- 9 BUILDING WALL LIGHTS ABOVE, TYP. SEE PHOTOMETRIC DRAWINGS
- 10 DASH-DOT OUTLINE INDICATED AREA OF ASSISTED RESCUE
- 11 6" TALL X 8" WIDE CONCRETE CURB AT EACH SIDE OF TRUCK DOCK, PAINT GUARDRAIL "SAFETY YELLOW". SEE DETAIL 1B, SHEET A01.1.
- 12 CONTINUOUS GUTTERS AND DOWNSPOUTS, SEE EXTERIOR ELEVATIONS, SHEET A03.1
- 13 TILT-UP CONCRETE WING WALL. SEE EXTERIOR ELEVATIONS A03.1 FOR FINISH AND COLOR

drawn by: TLG plot date: 09-03-2021

checked by: AGUJL

stamp



scale: AS NOTED

project number: 2204025.00

FLOOR PLAN

sheet no.:

A02.1

CLIENT:

McNeill Real Estate Services
Joseph A McNeill, III

916 718 5659
Ca DRE # 01138862

PRELIMINARY DESIGN DOCUMENTS FOR:

NORTHPOINT COMMERCE CENTER

NORTHPOINT PARKWAY AT THUNDERBOLT WAY
SANTA ROSA, CALIFORNIA

approved for the owner by:

approved for the architect by:

issue :	description :	date :
A	ISSUED FOR REVIEW	03-21-2023

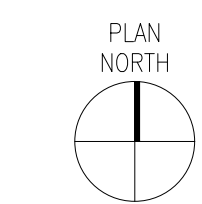
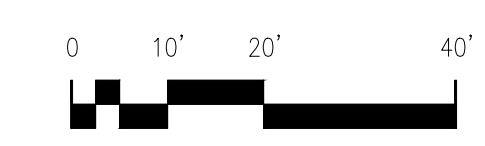
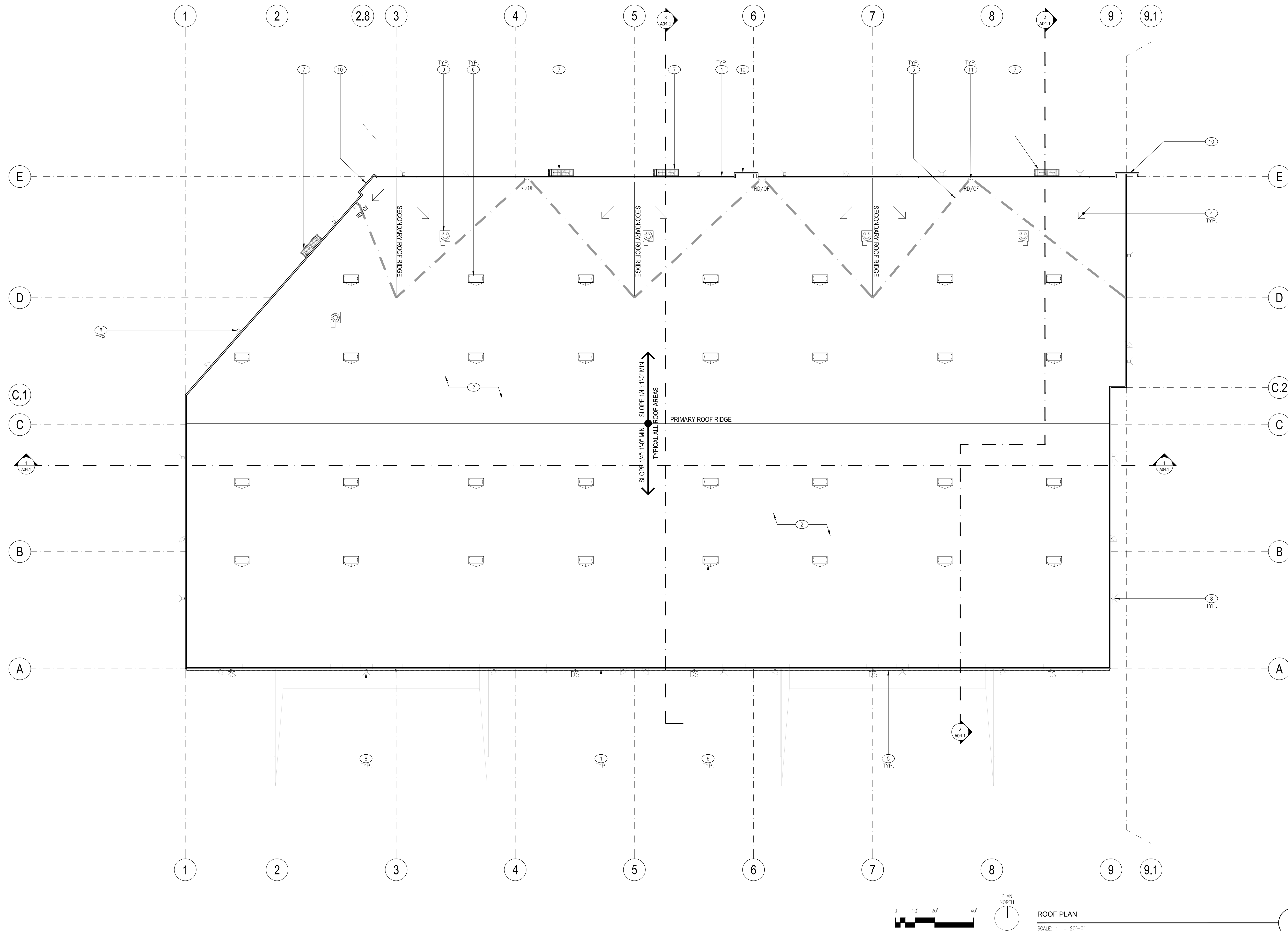

ROOF PLAN
SCALE: 1" = 20'-0"

1

KEYNOTES:

- | | |
|--|--|
| <ul style="list-style-type: none"> 1 LINE OF TYPICAL PARAPET WALL 2 TYPICAL LOW SLOPE ROOF 1/4" PER 12" MIN. SLOPE. ROOF ASSEMBLY CONSISTS OF A TPO SINGLE PLY SYSTEM OVER 1/2" STRUCTURAL SHEATHING OVER SLOPED STRUCTURAL FRAMING. 3 THICK DASHED GRAY LINE INDICATES WARPED ROOF AREA 4 INDICATES DIRECTION OF ROOF SLOPE 5 CONTINUOUS METAL GUTTER AND DOWNSPOUTS. PAINT TO MATCH ADJACENT BUILDING. SEE EXTERIOR ELEVATIONS FOR FINISH COLOR 6 INDICATES LOCATION OF 4' X 8' SELF-DURRING DUAL DOME SKYLIGHT. PROVIDE SHAPED FOAM CRICKET AT HIGH SIDE(S) OF SKYLIGHT CURB TO PROVIDE SLOPE FOR DRAINAGE 7 ENTRY STEEL CANOPY BELOW. SEE EXTERIOR ELEVATIONS, SHEET A03.1 FOR FINISHES. 8 EXTERIOR LED WALL LIGHTS. SEE SHEET A03.1 | <ul style="list-style-type: none"> 9 POTENTIAL LOCATION OF FUTURE ROOF MOUNTED HVAC EQUIPMENT. ALL ROOF MOUNTED EQUIPMENT SHALL BE DETERMINED AT TIME OF TENANT IMPROVEMENTS AND SHALL BE SCREENED FROM VIEW BY NATURE OF ITS PLACEMENT OR BY A FUTURE MECHANICAL SCREEN. 10 EXTERIOR TILT-UP CONCRETE ACCENT WALL. SEE SHEET EXTERIOR ELEVATIONS, SHEET A03.1. 11 INTERNAL ROOF AND ROOF-OFFLOW DRAINS |
|--|--|

drawn by: TLG plot date: 09-03-2021

checked by: AG/JDL

stamp

scale: AS NOTED

project number: 2204025.00

ROOF PLAN

sheet no.:

A02.2

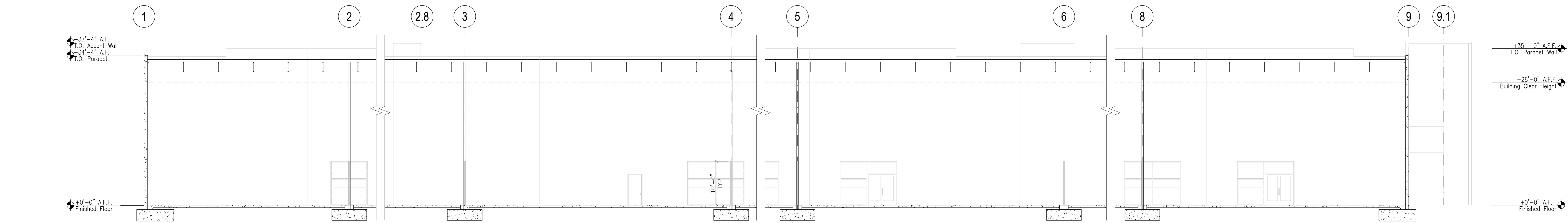

PRELIMINARY BUILDING SECTION 1
SCALE: 1" = 10'-0"

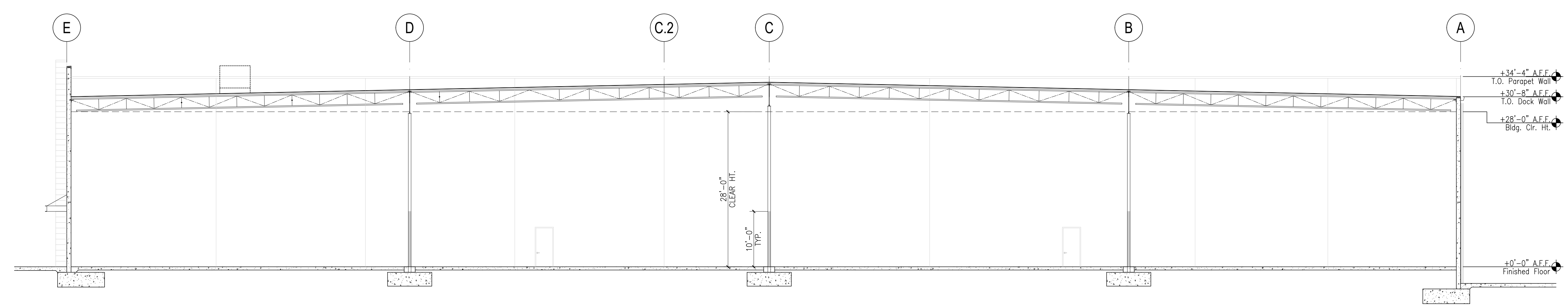

PRELIMINARY BUILDING SECTION 2
SCALE: 1" = 10'-0"

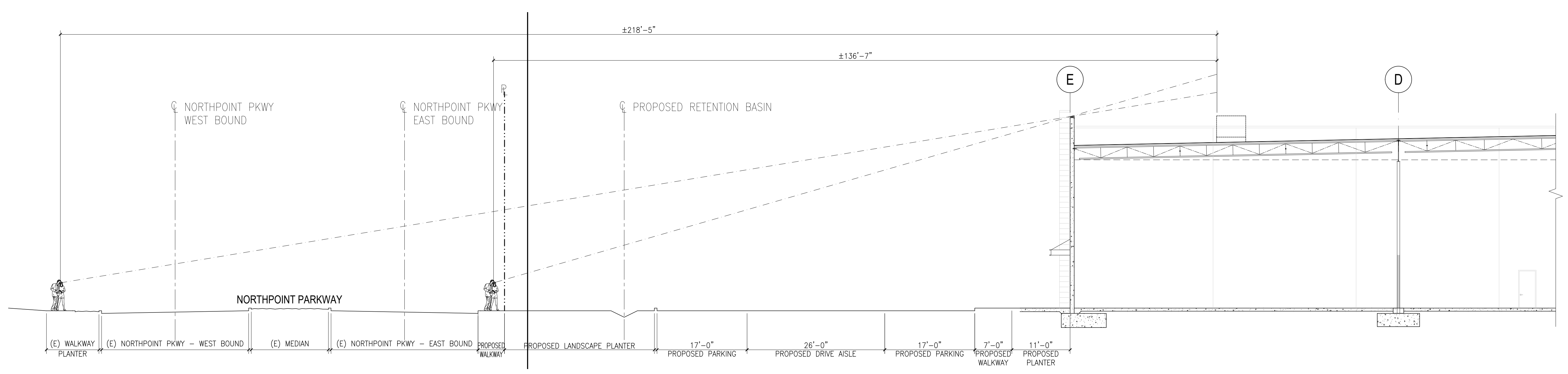

LINE OF SIGHT SECTION @ NORTHPOINT PARKWAY 3
SCALE: 1" = 10'-0"

CLIENT:

McNeill Real Estate Services
Joseph A McNeill, III

916 718 5659
Ca DRE # 01138862

PRELIMINARY DESIGN DOCUMENTS FOR:

NORTHPOINT COMMERCE CENTER

NORTHPOINT PARKWAY AT THUNDERBOLT WAY
SANTA ROSA, CALIFORNIA

approved for the owner by:

approved for the architect by:

issue :	description :	date :
A	ISSUED FOR REVIEW	03-21-2023

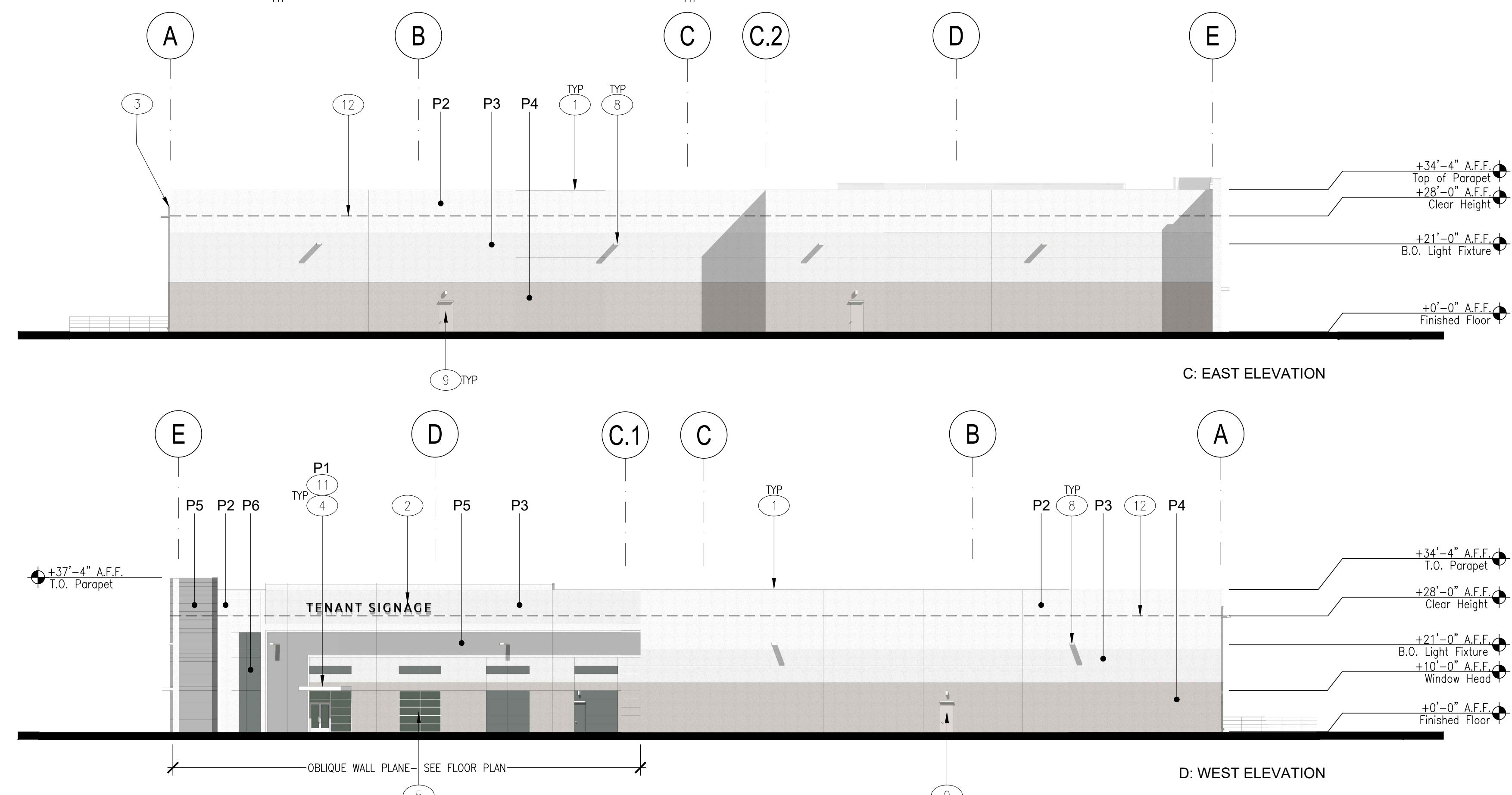
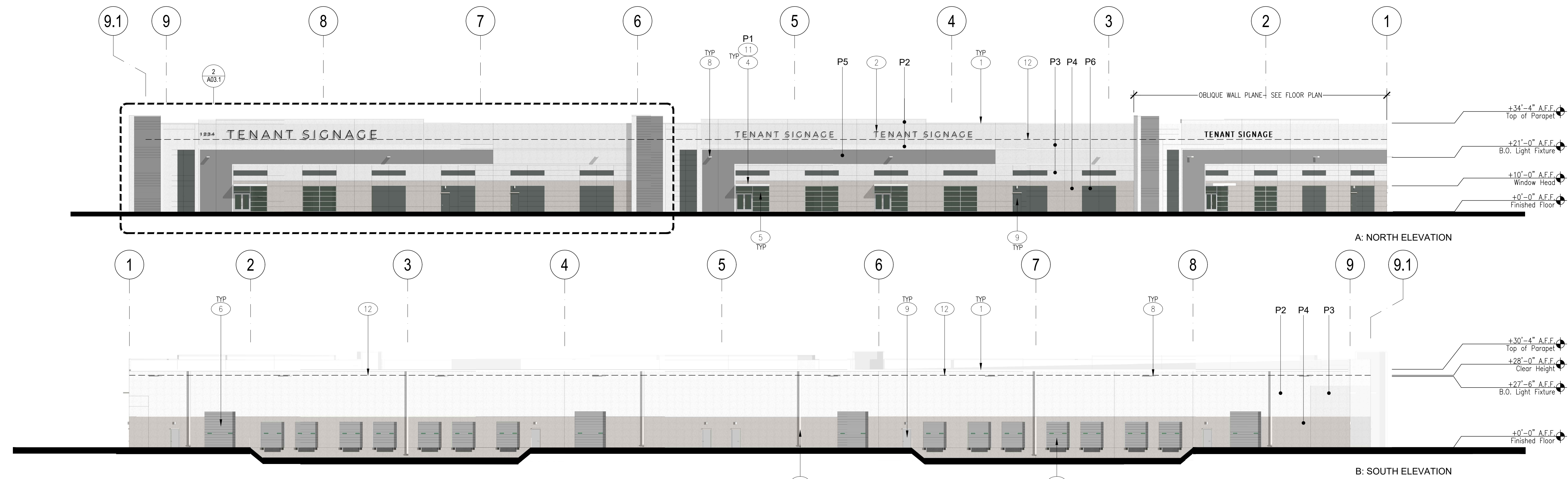

- KEYNOTES:**
- TYPICAL SITE CAST, CONCRETE TILT-UP PANELS WITH 3/4" REVEALS AND A MULTI COLOR TEXTURED COATING SYSTEM.
 - TENANT SIGNAGE UNDER SEPARATE PERMIT.
 - CONTINUOUS GUTTER AND SURFACE MOUNTED DOWNSPOUTS.
 - 12" THICK x 3'-11" DEEP x 13'-4" WIDE PAINTED STEEL CHANNEL CANOPIES, 4 TOTAL. PAINT AS SPECIFIED. TYPICAL AT MAIN ENTRANCE STOREFRONT OPENINGS.
 - TYPICAL WINDOW SYSTEM: DUAL PANE GLAZING IN 2" x 4" (NOMINAL) THERMALLY BROKEN, CLEAR ANODIZED ALUMINUM FRAMES. OUTER GLAZING PANE TO BE TINTED WITH LOW-E COATING ON INTERIOR SURFACE. INNER PANE CLEAR FLOAT. STOREFRONT DOORS WHERE SHOWN. 4 STOREFRONT LOCATIONS TOTAL.
 - 12' X 14' GRADE LEVEL ROLL UP DOOR, PAINT TO MATCH ADJACENT COLOR.
 - 9' X 10' DOCK LEVEL ROLL UP DOOR, PAINT TO MATCH ADJACENT COLOR.
 - EXTERIOR WALL PACK LIGHTING. SEE PHOTOMETRIC DRAWINGS.
 - 3' X 7' STEEL MAN DOOR WITH EMERGENCY LIGHT FIXTURE CENTERED OVER DOOR. SEE PHOTOMETRIC PLAN FOR FIXTURE TYPE. PAINT DOOR TO MATCH ADJACENT WALL COLOR.
 - ADDRESS SIGNAGE UNDER SEPARATE PERMIT AND SHALL MEET BUILDING, FIRE AND SHERIFF DEPT REQUIREMENTS.
 - CANOPY LIGHTING, SEE PHOTOMETRIC DRAWINGS.
 - DASHED LINE INDICATES INTERNAL CLEAR HEIGHT. SEE ELEVATIONS FOR HEIGHT.

FINISH LEGEND:

	P1: PAINT 1 SHERWIN WILLIAMS SW7757 HIGH REFLECTIVE WHITE		P2: PAINT 2 SHERWIN WILLIAMS SW7006 EXTRA WHITE
	P3: PAINT 3 SHERWIN WILLIAMS SW7646 FIRST STAR		P4: PAINT 4 SHERWIN WILLIAMS SW7016 MINDFUL GRAY
	P5: PAINT 5 SHERWIN WILLIAMS SW7670 GRAY SHINGLE		P6: PAINT 6 SHERWIN WILLIAMS SW6208 PEWTER GREEN
	GL1: VITRO ARCHITECTURAL GLASS "ATLANTICA" EMERALD GREEN GLASS IN THERMALLY BROKEN CLEAR ANODIZED ALUMINUM FRAMES		

EXTERIOR ELEVATIONS
SCALE: 1" = 20'-0"

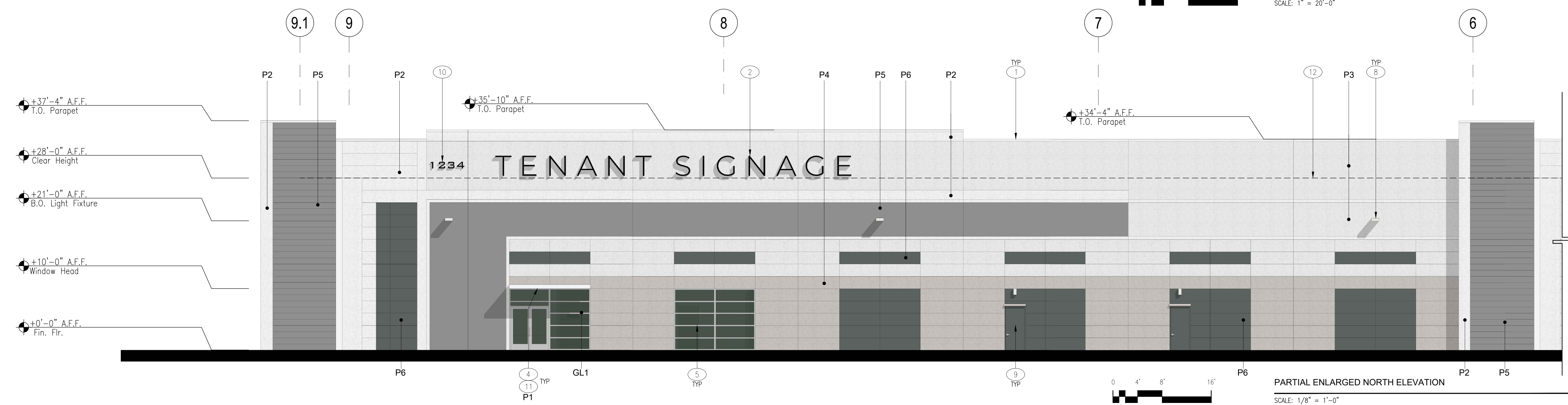

PARTIAL ENLARGED NORTH ELEVATION
SCALE: 1/8" = 1'-0"

drawn by: TLG plot date: 09-03-2021

checked by: AGJDL

stamp



scale: AS NOTED

project number: 2204025.00

EXTERIOR ELEVATIONS

sheet no.:

A03.1

PROJECT INFORMATION

PROJECT ADDRESS: 1408 THUNDERBOLT WAY
SANTA ROSA, CA 95407

OWNER/DEVELOPER: MCNEILL REAL ESTATE SERVICES, INC.
C/O: JOSE MCNEILL
5254 TAPESTRY COURT,
FAIRFIELD, CA 94534
(916) 719-5659

CIVIL ENGINEER: THOMAS J. BILLETTER, P.E.
BC ENGINEERING GROUP, INC.
418 B STREET, THIRD FLOOR
SANTA ROSA, CA 95401
(707) 542-4321

SURVEYOR: CINQUINI & PASSARINO, INC
1360 NORTH DUTTON AVENUE #150
SANTA ROSA, CA 95401
(707) 542-2106

AREA: 6.80 ACRES

**DESIGN REVIEW DRAWINGS FOR
NORTHPOINT COMMERCE CENTER
C/O JOSE MCNEILL - (916) 718-5659
THUNDERBOLT WAY, SANTA ROSA, CA 95407
APN: 035-530-023, -024, -025, -057**

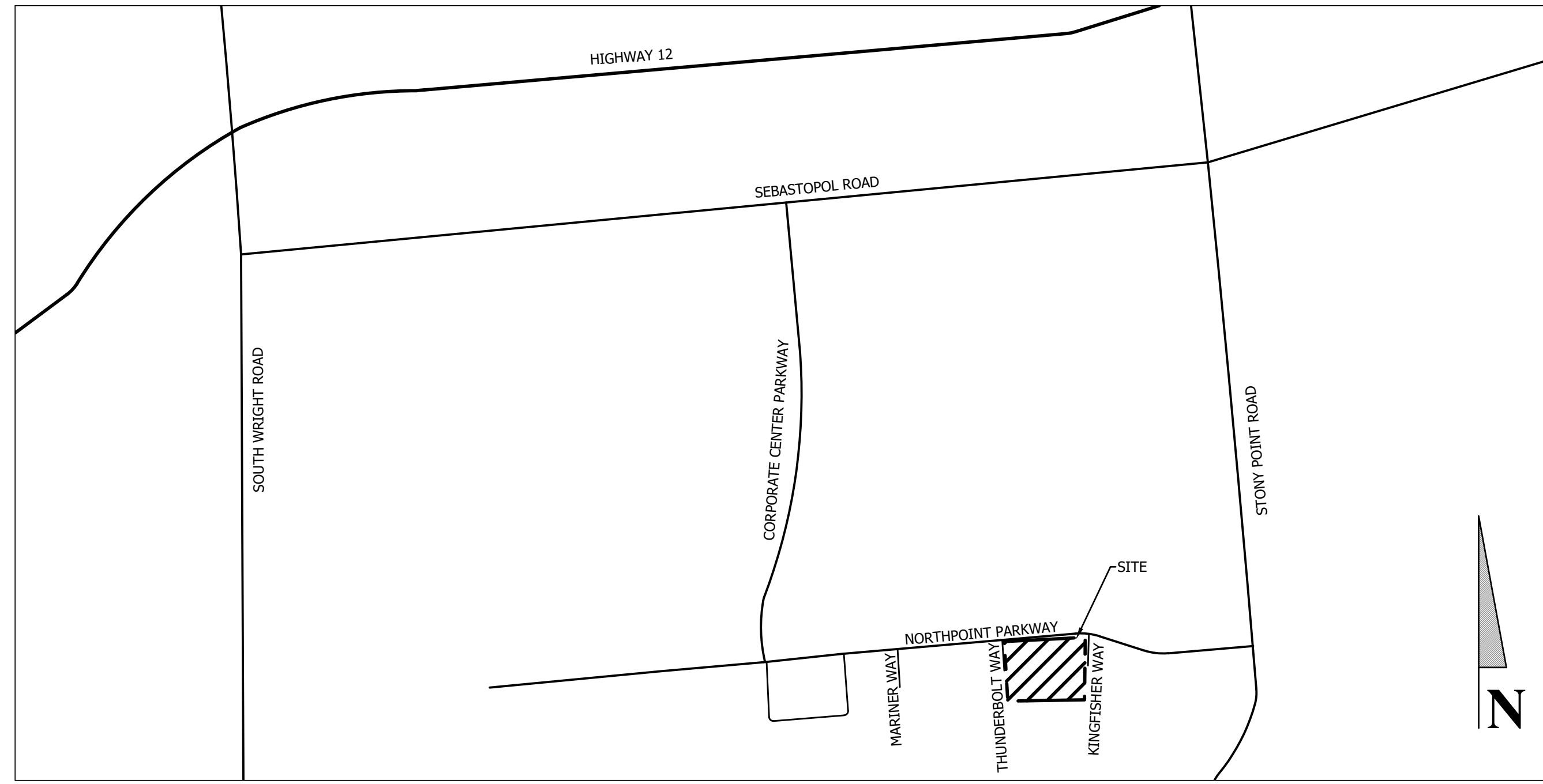

VICINITY MAP
NTS

SHEET INDEX

- C1.0 PROJECT INFO
- C1.1 GRADING AND UTILITY PLAN
- C1.2 CROSS SECTION VIEWS

DESIGN REVIEW NOTES

GENERAL PLAN DESIGNATION: BUSINESS PARK

CURRENT & PROPOSED ZONING: BP (BUSINESS PARK)

WATER SERVICE: CITY OF SANTA ROSA

SEWER SERVICE: CITY OF SANTA ROSA

PARKING SUMMARY:

STANDARD	101
COMPACT	43
ADA - STANDARD	6
ADA - VAN	0
MOTORCYCLE	0
EV CHARGING	12
FUTURE EV	0
TOTAL	156
BIKE	15
BUS	2
POLICE	4
STAFF	3

ABBREVIATIONS

AB	AGGREGATE BASE	GSL	GARAGE SETBACK LINE
AC	ASPHALT CONCRETE	GR	GRATE ELEVATION
APN	ASSESSOR'S PARCEL NUMBER	HP	HIGH POINT
BC	BEGIN HORIZONTAL CURVE	INV	INVERT
BSL	BUILDING SETBACK LINE	IG	INVERT GRADE
BW	BOTTOM OF WALL AT GRADE	LF	LINEAR FEET
BLDG	FINISH GRADE BUILDING	MAX	MAXIMUM
BT	BEGINNING OF TANGENT	ME	MATCH EXISTING
BVCE	BEGINNING OF VERTICAL CURVE ELEVATION	MIN	MINIMUM
BVCS	BEGINNING OF VERTICAL CURVE STATION	NTS	NOT TO SCALE
CL	CENTERLINE	PC	POINT OF CURVE
CL	CENTERLINE	PCC	POINT OF COMPOUND CURVE
CPP	CORRUGATED PLASTIC PIPE	PL	PROPERTY LINE
CONC	CONCRETE	PRC	POINT OF REVERSE CURVE
CY	CUBIC YARD	PT	POINT OF TANGENT
DI	DROP INLET	PUE	PUBLIC UTILITY EASEMENT
DIA	DIAMETER	PVI	POINT OF VERTICAL INTERSECTION
DL	DAYLIGHT	RC	RELATIVE COMPACTION
EC	END HORIZONTAL CURVE	R/W	RIGHT-OF-WAY
EG	EXISTING GROUND	S	SLOPE
EP	EDGE OF PAVEMENT	SAD	SEE ARCHITECTURAL DRAWINGS
ET	END OF TANGENT	SC	SPIRAL CURVE
EVCE	END OF VERTICAL CURVE ELEVATION	SD	STORM DRAIN PIPE
EVCS	END OF VERTICAL CURVE STATION	SDE	STORM DRAIN EASEMENT
EX	EXISTING	SE	SEWER EASEMENT
FF	FINISHED FLOOR	SG	SUBGRADE
FG	FINISHED GRADE	SWE	SIDEWALK EASEMENT
FL	FLOW LINE	STA	STATION
FS	FINISH SURFACE	TW	TOP OF WALL
FSS	FIRE SAFETY STANDARDS	TYP	TYPICAL
GB	GRADE BREAK	VC	VERTICAL CURVE

LEGEND

EXISTING	PROPOSED	DEFINITION
---	---	PROPERTY LINE
---	---	ROAD CENTERLINE
—E—	—E—	ELECTRICAL (UNDERGROUND)
—DHW—	—DHW—	ELECTRICAL (OVERHEAD WIRE)
—GAS—	—GAS—	GAS LINE
—H—	—H—	GATE VALVE
—H—	—H—	HYDRANT
—SS—	—SS—	PIPE CAP
—SS—	—SS—	POINT OF COORDINATION
—SS—	—SS—	SANITARY SEWER PIPE
—SS—	—SS—	STORM WATER DRAIN PIPE
—W—	—W—	STREET LIGHT
—W—	—W—	WATER LINE
—W—	—W—	DRAINAGE SWALE FLOW LINE
—X—	—X—	EDGE OF PAVEMENT
—X—	—X—	FENCE
—X—	—X—	FLOWLINE DIRECTION ARROW
—X—	—X—	GRADE BREAK
—X—	—X—	TREE TO BE REMOVED
[Pattern]	[Pattern]	CONCRETE
[Pattern]	[Pattern]	ROCK DISSIPATER/RIP RAP
[Pattern]	[Pattern]	BIORETENTION AREA

REV.	DESCRIPTION	DATE

BC ENGINEERING GROUP, INC.
CIVIL ENGINEERING & LAND PLANNING
 www.bceengineeringgroup.com
 Phone: 707.542.4321
 SANTA ROSA OFFICE:
 418 B Street, Third Floor, Santa Rosa CA 95401
 UKIAH OFFICE:
 603 S. State Street, Ukiah CA 95482



DESIGN REVIEW
PROJECT INFO
 NORTHPOINT COMMERCE CENTER
 1408 THUNDERBOLT WAY
 SANTA ROSA, CA 95407

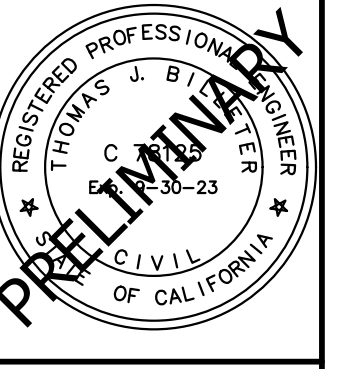

Date:	03-21-2023
Job:	1979-20
Drawn:	JF/MD
Scale:	AS SHOWN
APN:	035-530-023
Permit #:	
Sheet:	C1.0

NOT FOR CONSTRUCTION

S:\Clients\1979-20 Charlie Traboulsi - Thunderbolt Way (Northpoint Commerce Center), Santa Rosa, CA\CAD\Civil Engineering\Design Review\1979-20 Project Info.dwg 3/14/2023 11:14 AM Plotted by: Maiced

- KEYNOTES:**
- BIORETENTION AREA, SEE DETAIL THIS SHEET
 - PROPOSED SEWER SERVICE
 - PROPOSED MULTISERVICE MANIFOLD WITH DOUBLE DETECTOR CHECK, DOMESTIC METER, IRRIGATION METER, AND BACKFLOW PREVENTION DEVICES.
 - TRASH ENCLOSURE
 - 20' SWE AND PUE
 - 25' BSL
 - 20' SDE
 - 10' SE

AREA SUMMARY

DMA	TRIB AREA (SF)	BMP AREA (SF)	DEPTH (FT)
1	65,015	3,720	3
2	26,840	1,500	3
3	38,350	2,225	3
4	114,160	7,300	3
5	51,915	3,630	3

RUNOFF CURVE NUMBER FOR ALL TRIBUTARY AREAS IS 98.
 PRE-DEVELOPMENT IMPERVIOUS SURFACE: 104,458 SQ. FT.
 POST-DEVELOPMENT IMPERVIOUS SURFACE: 241,306 SQ. FT.

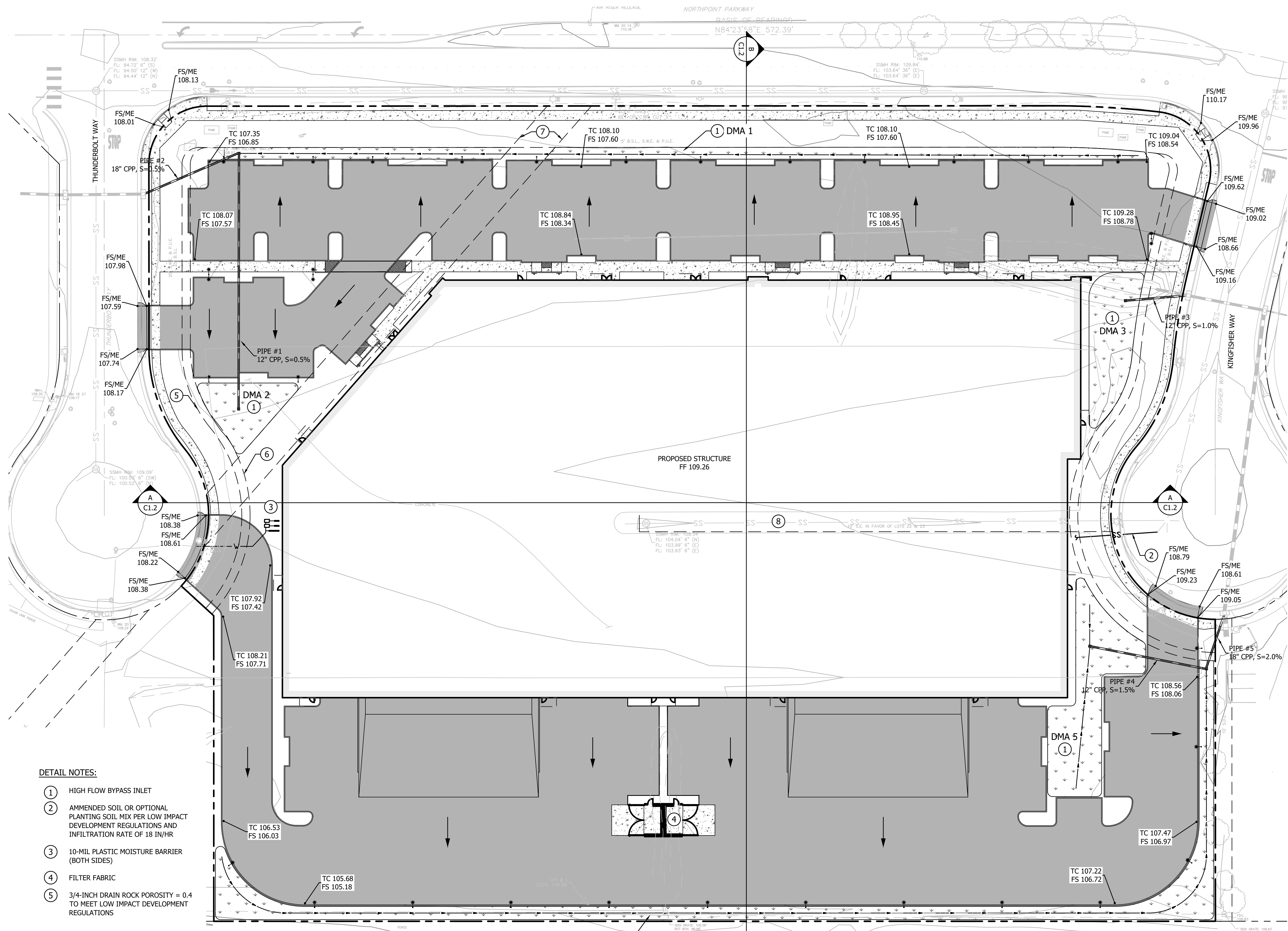
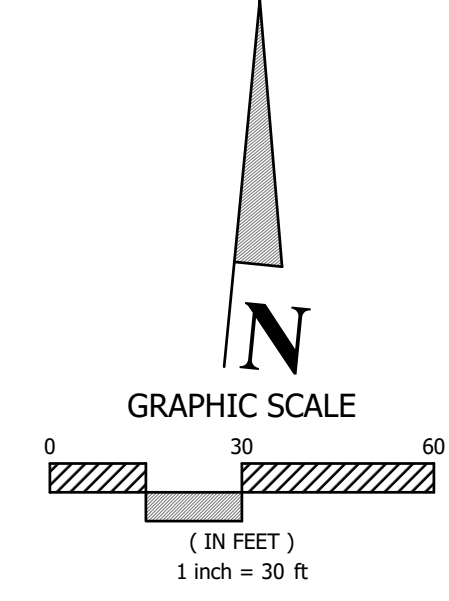

- DETAIL NOTES:**
- HIGH FLOW BYPASS INLET
 - AMENDED SOIL OR OPTIONAL PLANTING SOIL MIX PER LOW IMPACT DEVELOPMENT REGULATIONS AND INFILTRATION RATE OF 18 IN/HR
 - 10-MIL PLASTIC MOISTURE BARRIER (BOTH SIDES)
 - FILTER FABRIC
 - 3/4-INCH DRAIN ROCK POROSITY = 0.4 TO MEET LOW IMPACT DEVELOPMENT REGULATIONS

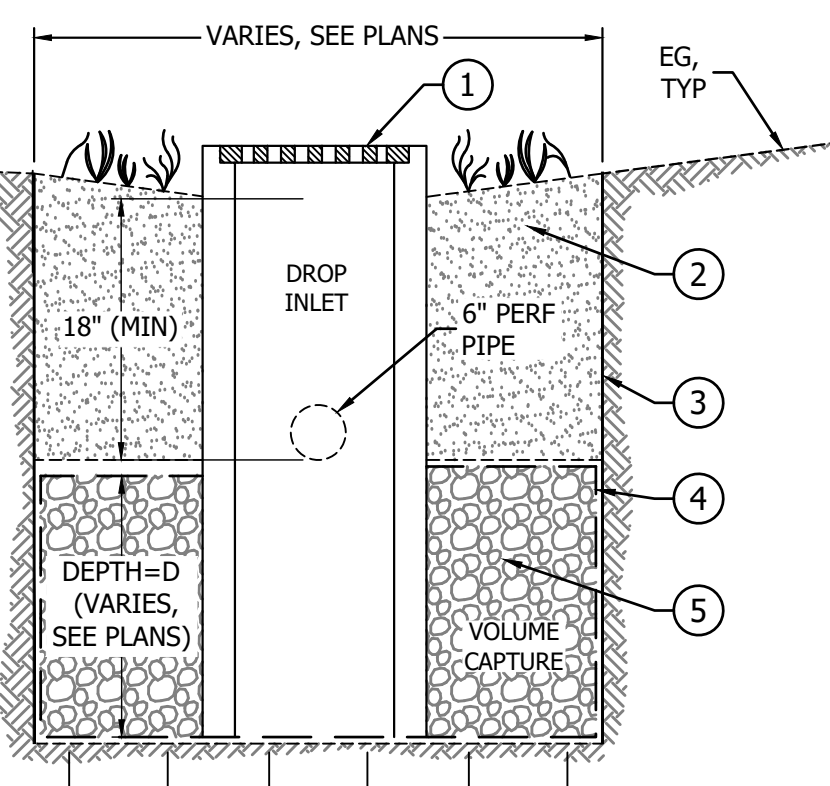

- NOTES:**
- SOIL TO BE SPECIFIED BY DESIGN ENGINEER TO PROVIDE VOLUME CAPTURE AND MEET GOVERNING AGENCY REQUIREMENTS. IF NON STRUCTURAL SOIL IS SELECTED A CUTOFF WALL IS REQUIRED IN PLACE OF MOISTURE BARRIER.
 - SWALE MUST CONVEY DESIGN FLOWS PER GOVERNING AGENCY DESIGN STANDARDS.
 - TOP OF 6" PERFORATED PIPE TO BE SET 6" BELOW BOTTOM OF ROAD STRUCTURAL SECTION.

BR BIORETENTION DETAIL

NO SCALE

NOT FOR CONSTRUCTION

REV.	DATE	DESCRIPTION

BC ENGINEERING GROUP, INC.
 CIVIL ENGINEERING & LAND PLANNING
 www.bceengineeringgroup.com
 Phone: 707-542-4321
 SANTA ROSA OFFICE: 418 B Street, Third Floor, Santa Rosa CA 95401
 UKIAH OFFICE: 603 S. State Street, Ukiah CA 95482

DESIGN REVIEW
 GRADING AND UTILITY PLAN
 NORTHPOINT COMMERCE CENTER
 1408 THUNDERBOLT WAY
 SANTA ROSA, CA 95407

PROFESSIONAL SEAL
 REGISTERED PROFESSIONAL ENGINEER
 TREVAS J. B. MCMILLAN
 CIVIL
 OF CALIFORNIA
 No. 30223

Date: 03-21-2023
 Job: 1979-20
 Drawn: JF/MD
 Scale: AS SHOWN
 APN: 035-530-023
 Permit #:
 Sheet: **C1.1**
 2 of 3

3/14/2023 11:14 AM Plotted by: Marcel S:\Clients\1979-20 Chelle Traboulsi - Thunderbolt Way (Northpoint Commerce Center), Santa Rosa, CA\CAD\Civil Engineering\Design Review\1979-20 Grading and Utility Plan.dwg

S:\Clients\1979-20 Charlie Traboulsi - Thunderbolt Way (Northpoint Commerce Center), Santa Rosa, CA\CAD\Civil Engineering\Design Review\1979-20 Grading and Utility Plan.dwg

3/14/2023 11:19 AM Printed by Marcel

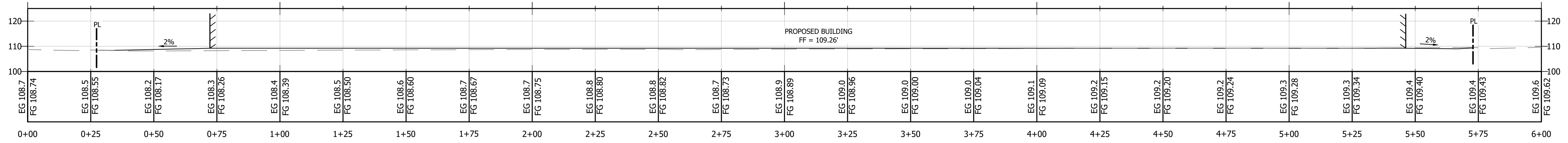

SITE SECTION A-A
HORIZONTAL SCALE: 1"=20'
VERTICAL SCALE: 1"=20'

SITE SECTION LEGEND

- FINISH GRADE
- EXISTING GRADE
- - - - - PROPERTY LINE

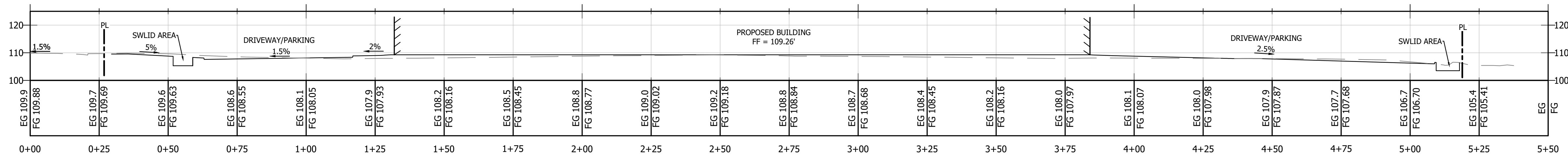

SITE SECTION B-B
HORIZONTAL SCALE: 1"=20'
VERTICAL SCALE: 1"=20'

REV.	DESCRIPTION	BY	DATE

BC ENGINEERING GROUP, INC.
CIVIL ENGINEERING & LAND PLANNING
www.bceengineeringgroup.com
Phone: 707.542.4321
SANTA ROSA OFFICE:
418 B Street, Third Floor, Santa Rosa CA 95401
UKIAH OFFICE:
603 S. State Street, Ukiah CA 95482



DESIGN REVIEW
CROSS SECTION VIEWS
NORTHPOINT COMMERCE CENTER
1408 THUNDERBOLT WAY
SANTA ROSA, CA 95407

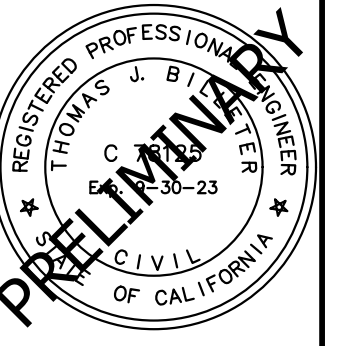

Date:	03-21-2023
Job:	1979-20
Drawn:	JF/MD
Scale:	AS SHOWN
APN:	035-530-023
Permit #:	
Sheet:	C1.2

NOT FOR CONSTRUCTION

LANDSCAPE DESIGN INTENT:

• Landscape design intent: The designed landscape will create continuity with the adjacent landscapes in the development and provide year-round interest in foliage color and form to soften and enhance the look of the new architecture. Signature street trees are selected from the City of Santa Rosa's approved street tree list for narrow spaces and are planted along Northpoint Parkway and Mariner Way on a grid, representing an orchard format. Plant materials selected consist of almost exclusively low water-use and low maintenance species, many native to the area. Understory and ground cover plantings are generally low profile in stature so as not to interfere with visual access into and within the site. Organic layout of shrubs and ground covers provide a natural-looking landscape. Plant selection emphasizes foliage form and color for year-long attractiveness and structure, with adequate spacing to discourage hard pruning. Dense ground covers provide weed and erosion control and ground covers selected from among fire-resistant species will be planted along the Parkway to provide a fire buffer to the site. No turf grass areas are proposed.

• Tree quantities and placement: New tree counts exceed the quantity required by the City's tree/parking ratio. Parking areas contain (36) trees at a 1:4.5 ratio with the (164) proposed parking spaces. There are an additional (24) trees for the remaining 24,500 square feet of landscaped area, or (1) tree for every 600 square feet of landscaped area. Street trees are provided at 1 per 20-feet of commercial frontage per the City Design Guidelines (Streetscapes). Street trees are held back 30-feet from the corner curb return.

• Sound mitigation for neighboring properties: A new 8' tall, poured-in-place, integrally colored concrete site wall will be located along the south project border, to provide visual and sound mitigation for residences to the south. The south face of the wall will be planted with a vigorous, climbing vine to soften and green it's view.

• Planting scheme at property lines and entries: Enhanced entry planting will direct users to entry points via bold year-round color and textural contrast. To supplement the screening provided by trees on adjacent parcels, new tree species along the west property line have been added. Trees are located so that at maturity they do not interfere with safe sight distances for vehicular, bicycle, or pedestrian traffic nor will they conflict with overhead utility lines, overhead lights, or walkway lights.

• Root barriers: Appropriate root barriers shall be provided in any planters and parking islands less than 10' in width.

• Existing trees: There are no existing trees on site that will require removal.

IRRIGATION STATEMENT:

• All landscaped areas will be provided with an approved, fully automated irrigation system to include an automatic master control with multi-calendar, timer, and multi-station capabilities, in compliance with Section 20-34.060 and with the City's Water Efficient Landscape Ordinance.

• Irrigation system will be designed to avoid runoff, low head drainage, overspray or other similar conditions where water flows onto adjacent property, non-irrigated areas, walks, roadways or structures. Proper irrigation equipment and schedules, including repeat cycles, shall be used to closely match application rates to infiltration rates to minimize runoff. Plants with similar water requirements shall be grouped together in distinct hydrozones.

• A master valve and flow sensor will be provided near the irrigation point of connection and connected to the automatic irrigation controller to sense and shutdown the system in case of a catastrophic event. All ground cover, shrub, and perennial planting areas will receive a high-efficiency inline drip system. The automatic irrigation controller will utilize either evapotranspiration or soil moisture sensor data with non-volatile memory. Sensors (rain, freeze, wind, etc.), either integral or auxiliary, that suspend or alter irrigation operation during unfavorable weather conditions will be provided for all zones.

PROPOSED TREE LIST

SYMBOL	BOTANICAL NAME	COMMON NAME	WUCOLS WATER USE CATEGORY	INITIAL SIZE	HEIGHT X WIDTH AT MATURITY	QTY **	DESCRIPTION
	<i>Arbutus 'Marina'</i>	Strawberry Tree	Low	24" Box	20' x 20'	17	Evergreen accent tree
	<i>Cercis occidentalis</i>	Western Redbud	Low	15 Gal	15' x 15'	11	Deciduous accent tree
	<i>Ginkgo biloba 'Saratoga'</i>	Maidenhair Tree	Moderate	15 Gal	30' x 50'	7	Deciduous accent tree
	<i>Magnolia 'Little Gem'</i>	Dwarf Magnolia	Moderate	15 Gal	18' x 8'	5	Evergreen accent tree
	<i>Pistacia c. 'Keith Davy'</i>	Chinese Pistache	Low	36" Box	25' x 25'	17	Deciduous shade tree
	<i>Quercus agrifolia</i>	Coast Live Oak	Low	15 Gal	20-75' x 30-60'	6	Native Oak/storm retention area

** Refer to Landscape Design Intent Statement above for more information on tree quantities required.

PROPOSED PLANT LIST

SYMBOL	BOTANICAL NAME	COMMON NAME	WUCOLS WATER USE CATEGORY	INITIAL SIZE	ON CENTER SPACING	DESCRIPTION
Shrubs						
	<i>Arctostaphylos 'Sunset'</i>	Sunset Manzanita	Low	5 Gal	5'-0" o.c.	Evergreen foundation shrub
	<i>Berberis atropurpurea</i>	Japanese Barberry	Low	5 Gal	4'-0" o.c.	Deciduous foundation shrub
	<i>Ceanothus 'Siyah'</i>	Wild Lilac	Low	5 Gal	6'-0" o.c.	Evergreen foundation shrub
	<i>Heteromeles arbutifolia</i>	Toyon	Low	5 Gal	8'-0" o.c.	Evergreen foundation shrub
	<i>Cistus salviifolius</i>	White Rockrose	Low	5 Gal	4'-0" o.c.	Evergreen foundation shrub
	<i>Lomandra longifolia 'Breeze'</i>	Dwarf Mat Rush	Low	5 Gal	3'-0" o.c.	Evergreen "grass-like" shrub
	<i>Grevillea noelii</i>	Grevillea	Low	5 Gal	5'-0" o.c.	Evergreen foundation shrub
	<i>Pennisetum orientale</i>	Fountain Grass	Low	1 Gal	3'-0" o.c.	Ornamental Grass
	<i>Rosa 'Flower Carpet Red Rose'</i>	Rosa x 'Noare'	Moderate	5 Gal	3'-0" o.c.	Semi-deciduous accent shrub
	<i>Salvia greggii 'Purple'</i>	Purple Sage	Low	5 Gal	3'-0" o.c.	Evergreen foundation shrub
	<i>Xylosma c. compacta</i>	Compact Xylosma	Low	5 Gal	5'-0" o.c.	Evergreen hedge shrub
Ground Cover						
	<i>Ceanothus g.h. 'Yankee Point'</i>	California Lilac	Low	5 Gal	6'-0" o.c.	Evergreen ground cover
	<i>Coprosma p. 'Verde Vista'</i>	Coprosma	Low	5 Gal	5'-0" o.c.	Evergreen ground cover
	<i>Cotoneaster lowfast</i>	Bearberry	Low	5 Gal	5'-0" o.c.	Evergreen ground cover
Storm Retention Planting						
	<i>Carex divulsa</i>	Berkeley Sedge	Low	1 Gal	2'-0" o.c.	Water-tolerant ornamental grass
	<i>Chondropetalum lecturum</i>	Small Cape Rush	Low	1 Gal	4'-0" o.c.	Water-tolerant ornamental grass
Corner/Entry Treatment						
	<i>Coleonema p. 'Sunset Gold'</i>	Bright Star Yucca	Moderate	5 Gal	4'-0" o.c.	Evergreen foundation shrub
	<i>Cotoneaster lowfast</i>	Bearberry	Low	5 Gal	5'-0" o.c.	Evergreen ground cover
	<i>Lomandra longifolia 'Breeze'</i>	Dwarf Mat Rush	Low	5 Gal	3'-0" o.c.	Evergreen "grass-like" shrub
	<i>Loropetalum chinense</i>	Chinese Fringe Flower	Moderate	5 Gal	5'-0" o.c.	Evergreen foundation shrub
Vines						
	<i>Parthenocissus tricuspidata</i>	Boston Ivy	Low	1 Gal	4'-0" o.c.	Deciduous Climbing Vine

THUNDERBOLT WAY

NORTHPOINT PARKWAY

KINGFISHER WAY

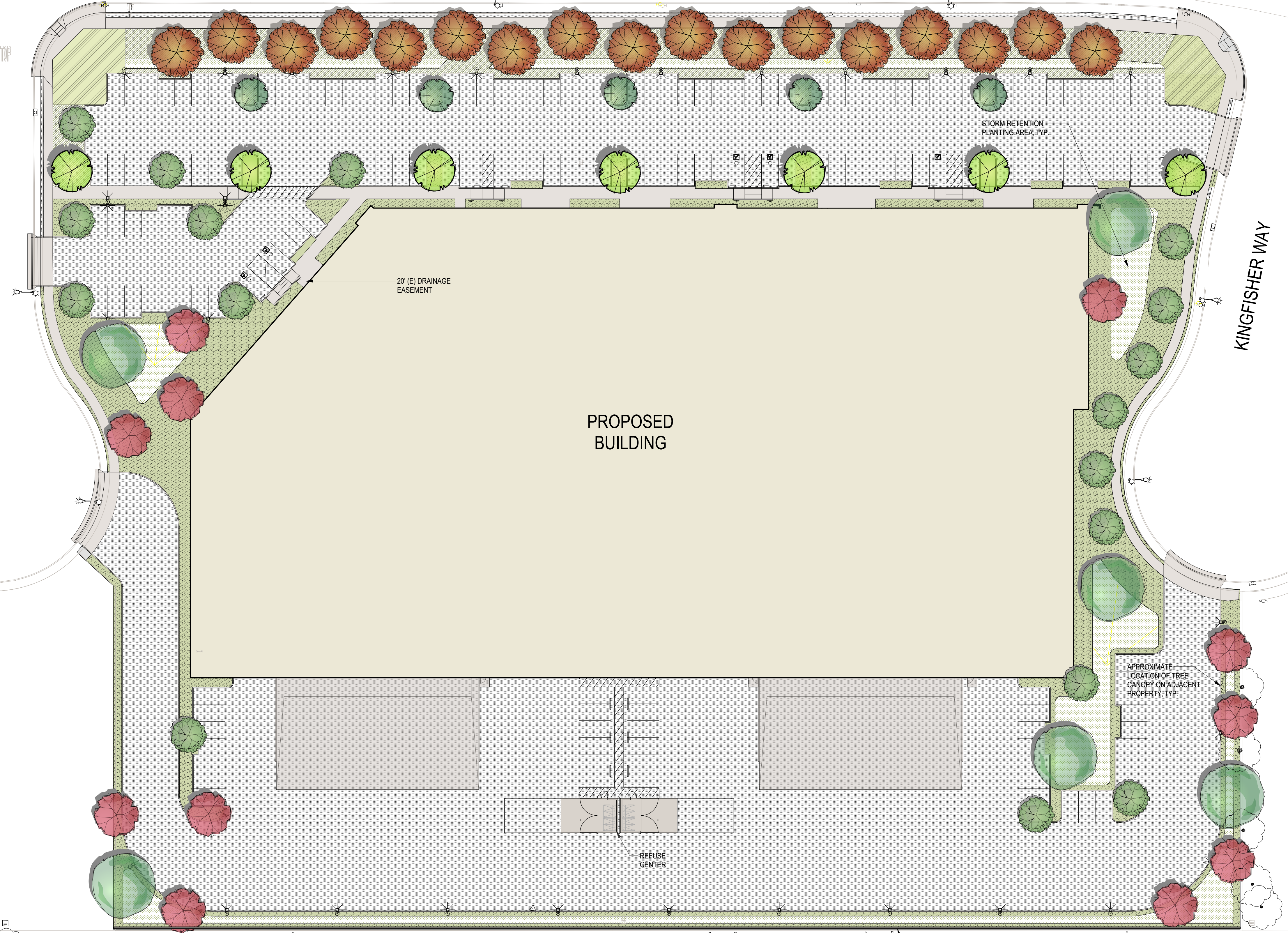

PROPOSED TREE IMAGERY

Pistacia chinensis - Chinese Pistache



Quercus agrifolia - Coast Live Oak



Arbutus 'Marina' - Strawberry Tree



Cercis occidentalis - Western Redbud

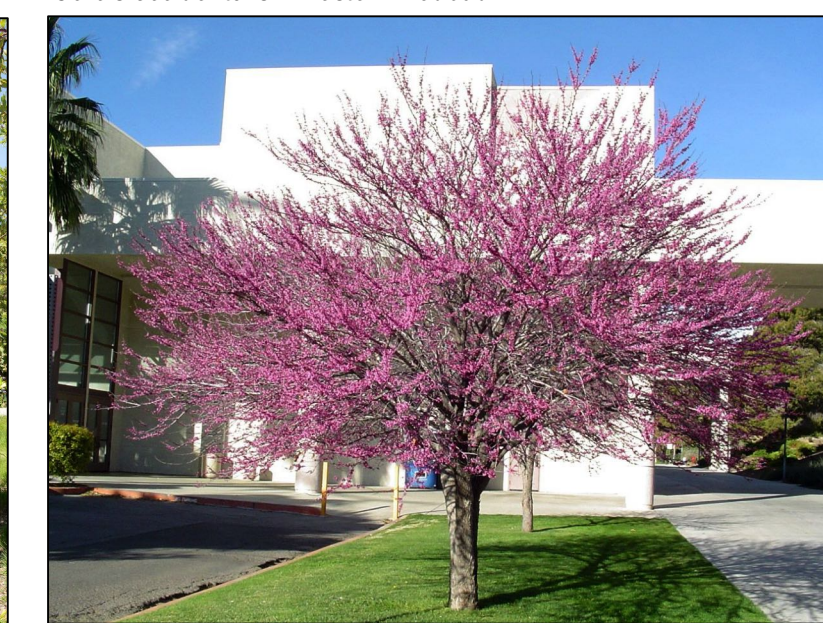

Magnolia 'Little Gem' - Dwarf Magnolia



Ginkgo biloba 'Saratoga' - Maidenhair Tree



DESIREE GARON

LANDSCAPE ARCHITECT

308 HATCHERY LANE
SONOMA, CA 95476
PH (707) 694-6139

CALIFORNIA PLA #5216
EXP 11/30/21

NORTHPOINT COMMERCE CENTER

NORTHPOINT PARKWAY
AT THUNDERBOLT WAY
SANTA ROSA, CA
95407

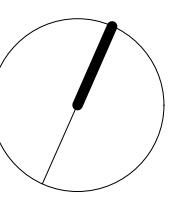

REVISIONS

DATE: 03-21-2023

SCALE: 1" = 30'-0"

DRAWN: DJG

LANDSCAPE SITE PLAN

L1.0

CLIENT:

McNeill Real Estate Services
Joseph A McNeill, III

916 718 5659
Ca DRE # 01138862

PRELIMINARY DESIGN DOCUMENTS FOR:

NEW WAREHOUSE BUILDING

NORTHPOINT PARKWAY AT THUNDERBOLT WAY

SANTA ROSA, CALIFORNIA

approved for the owner by:

approved for the architect by:

issue	description	date
A	ISSUED FOR REVIEW	03-21-2023

(insert consultant name, address here)

drawn by: TLG plot date: 09-03-2021

checked by: AG/IDL

stamp

scale: AS NOTED

project number: 2204025.00

PRELIMINARY LIGHTING SITE PLAN

sheet no.:

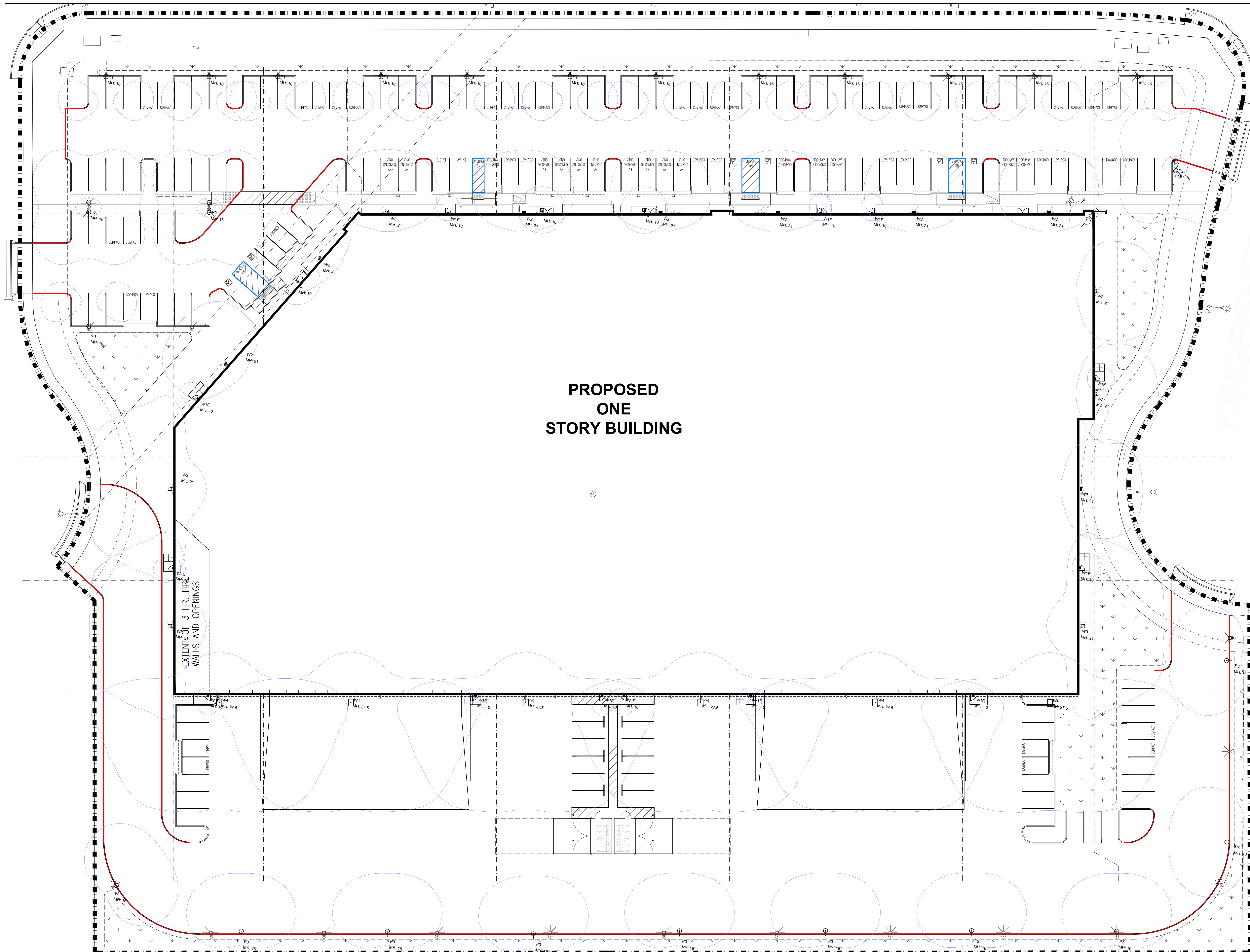

PROPOSED ONE STORY BUILDING

EXTENT OF 3 HR. FIRE WALLS AND OPENINGS

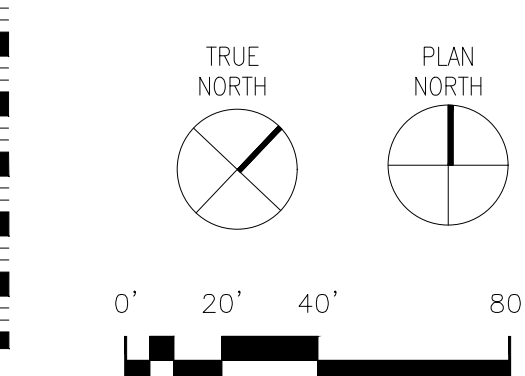

Symbol	Qty	Label	Arrangement	Total Lamp Lumens	LLF	Description	Lum. Watts	Total Watts	[MANUFAC]	BUG Rating
○	10	P3	Single	N.A.	0.900	TT-D5-740-U-T4-PM ON 16 FT POLE+ BASE	62.3	623	COOPER LIGHTING SOLUTIONS - MCGRAW-EDISON (FORMERLY EATON)	B2-U0-G3
□	3	D	Single	2352	0.900	SCP-S-20-LG-VS-4K	20.49	61.47	BARRON LIGHTING GROUP	N.A.
○	14	P1	SINGLE	N.A.	0.900	TT-D3-740-U-T4-PM ON 16 FT POLE+ BASE	48.8	683.2	COOPER LIGHTING SOLUTIONS - MCGRAW-EDISON (FORMERLY EATON)	B2-U0-G3
○	3	P2	BACK-BACK	N.A.	0.900	(2) TT-D3-740-U-T4-PM @ 180 DEGREES ON 16 FT POLE+ BASE	48.8	292.8	COOPER LIGHTING SOLUTIONS - MCGRAW-EDISON (FORMERLY EATON)	B2-U0-G3
○	13	W1E	SINGLE	N.A.	0.900	131-0233 us MOUNTING HEIGHT 10 FT	16	208	WE-EF USA	N.A.
○	11	W2	SINGLE	7985.16	0.900	070449 MOUNING HEIGHT 21 FT	80	880	Performance IN Lighting	B2-U0-G1
○	3	W3	SINGLE	N.A.	0.900	PRV-PA2A-740-U-T4W	112	336	COOPER LIGHTING SOLUTIONS - LUMARK (FORMERLY EATON)	B3-U0-G3
○	6	W4	SINGLE	N.A.	0.900	PRV-XL-PA3B-740-U-T4W	234	1404	COOPER LIGHTING SOLUTIONS - LUMARK (FORMERLY EATON)	B3-U0-G5

Label	CalcType	Units	Avg	Max	Min	Avg/Min	Max/Min
EAST DOCK	Illuminance	Fc	3.2	4.1	2.4	1.3	1.7
NORTH POINT PKG	Illuminance	Fc	1.9	5.3	1.0	1.9	5.3
NORTH SIDE PEDESTRIAN	Illuminance	Fc	3.3	12.5	1.0	3.3	12.5
SOUTH WEST TRUCK DRIVEWAY	Illuminance	Fc	2.3	6.5	1.0	2.3	6.5
WEST DOCK	Illuminance	Fc	3.5	4.6	2.5	1.4	1.8

PRELIMINARY LIGHTING SITE PLAN

SCALE: 1" = 20'-0"

LIGHTING NOTES:
POLE LIGHTS MOUNTING HEIGHT IS 16 FT (POLE+BASE+LIGHT)
BUILDING DOCK LIGHTS MOUNTING HEIGHT IS 27'-6"
BUILDING LIGHTS MOUNTING HEIGHT IS 21'-0"
BUILDING ABOVE DOORS EMERGENCY LIGHTS TYPE W1E MOUNTING HEIGHT IS 10 FT
ALL LIGHTS ARE FULL CUT-OFF

CLIENT:

McNeill Real Estate Services
Joseph A McNeill, III

916 718 5659
Ca DRE # 01138862

PRELIMINARY DESIGN DOCUMENTS FOR:

NEW WAREHOUSE BUILDING

NORTHPOINT PARKWAY AT THUNDERBOLT WAY

SANTA ROSA, CALIFORNIA

approved for the owner by:

approved for the architect by:

issue	description	date
A	ISSUED FOR REVIEW	03-21-2023

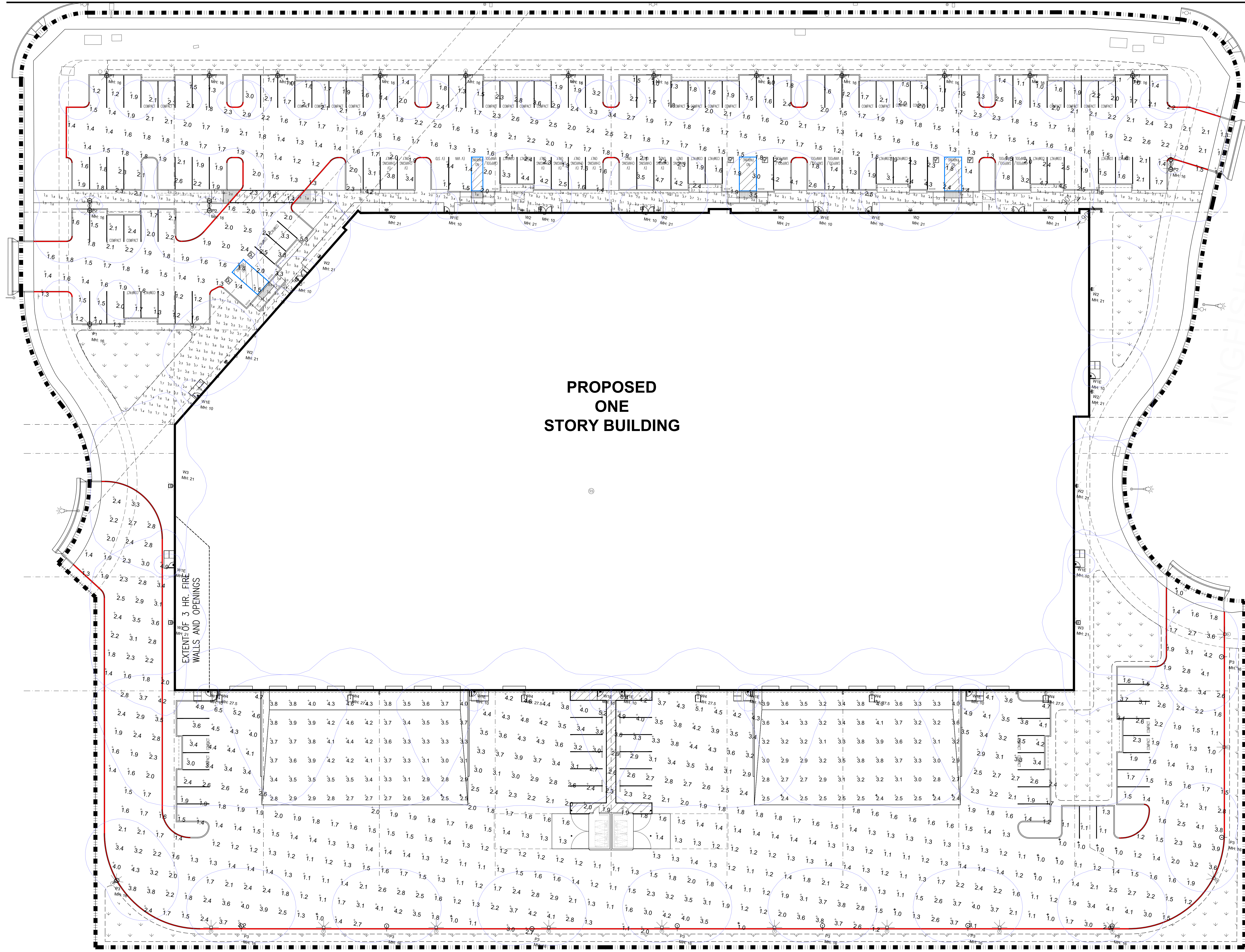

PROPOSED ONE STORY BUILDING

EXTENT OF 3 HR. FIRE WALLS AND OPENINGS

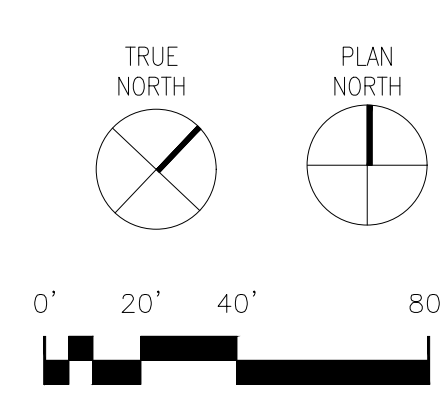

Symbol	Qty	Label	Arrangement	Total Lamp Lumens	LLF	Description	Lum. Watts	Total Watts	[MANUFAC]	BUG Rating
⊙	10	P3	Single	N.A.	0.900	TT-05-740-U-T4-PM ON 16 FT POLE+ BASE	62.3	623	COOPER LIGHTING SOLUTIONS - MCGRAW-EDISON (FORMERLY EATON)	B2-U0-G3
□	3	D	Single	2352	0.900	SCP-S-20-LG-VS-4K	20.49	61.47	BARRON LIGHTING GROUP	N.A.
⊙	14	P1	SINGLE	N.A.	0.900	TT-03-740-U-T4-PM ON 16 FT POLE+ BASE	48.8	683.2	COOPER LIGHTING SOLUTIONS - MCGRAW-EDISON (FORMERLY EATON)	B2-U0-G3
⊙	3	P2	BACK-BACK	N.A.	0.900	(2) TT-03-740-U-T4-PM @ 180 DEGREES ON 16 FT POLE+ BASE	48.8	292.8	COOPER LIGHTING SOLUTIONS - MCGRAW-EDISON (FORMERLY EATON)	B2-U0-G3
⊙	13	W1E	SINGLE	N.A.	0.900	131-0233_us MOUNTING HEIGHT 10 FT	16	208	WE-EF USA	N.A.
⊙	11	W2	SINGLE	7985.16	0.900	070449 MOUNTING HEIGHT 21 FT	80	880	Performance IN Lighting	B2-U0-G1
⊙	3	W3	SINGLE	N.A.	0.900	PRV-PAZA-740-U-T4W	112	336	COOPER LIGHTING SOLUTIONS - LUMARK (FORMERLY EATON)	B3-U0-G3
⊙	6	W4	SINGLE	N.A.	0.900	PRV-XL-PA3B-740-U-T4W	234	1404	COOPER LIGHTING SOLUTIONS - LUMARK (FORMERLY EATON)	B3-U0-G5

Label	CalcType	Units	Avg	Max	Min	Avg/Min	Max/Min
EAST DOCK	Illuminance	Fc	3.2	4.1	2.4	1.3	1.7
NORTH POINT PKG	Illuminance	Fc	1.9	5.3	1.0	1.9	5.3
NORTH SIDE PEDESTRIAN	Illuminance	Fc	3.3	12.5	1.0	3.3	12.5
SOUTH WEST TRUCK DRIVEWAY	Illuminance	Fc	2.3	6.5	1.0	2.3	6.5
WEST DOCK	Illuminance	Fc	3.5	4.6	2.5	1.4	1.8

PRELIMINARY PHOTOMETRIC OVERALL LIGHTING SITE PLAN

SCALE: 1" = 20'-0"

1

LIGHTING NOTES:
POLE LIGHTS MOUNTING HEIGHT IS 16 FT (POLE+BASE+LIGHT)
BUILDING DOCK LIGHTS MOUNTING HEIGHT IS 27'-6"
BUILDING LIGHTS MOUNTING HEIGHT IS 21'-0"
BUILDING ABOVE DOORS EMERGENCY LIGHTS TYPE W1E MOUNTING HEIGHT IS 10 FT
ALL LIGHTS ARE FULL CUT-OFF

scale: AS NOTED
project number: 2204025.00

PRELIMINARY PHOTOMETRIC LIGHTING SITE PLAN

sheet no.:

PH01.1

